

THE  
DISTRIBUTOR'S

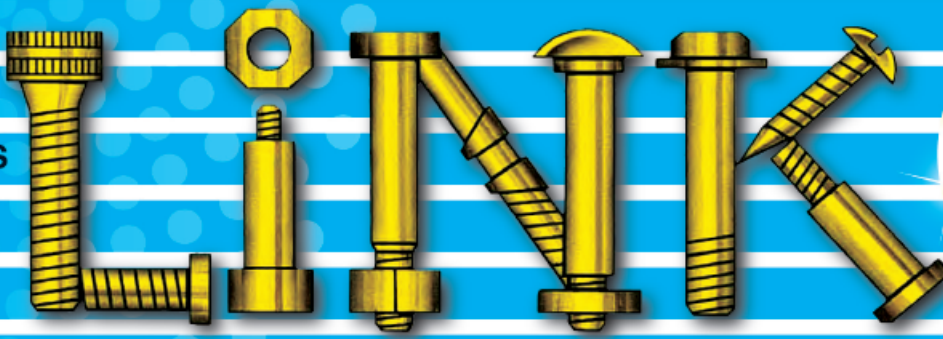

THE NATIONAL MAGAZINE FOR FASTENER DISTRIBUTORS



**20** Years  
Strong  
1992-2012

Volt Industrial Plastics  
Celebrates 20th Anniversary of  
**Plastic** Fastener Manufacturing

See story on page 16



Made in  
the USA  
Yellville, Arkansas



# Don't get Tangled up with the Wrong Supplier

Elite Sales has a deep and varied line of inventory with thousands of products always in stock. And if we don't have it, we will customize a solution that meets your needs.

That's the Elite Sales advantage. As one of the leading importers and wholesale distributors of Wire Rope, Cable, Strand, Chain and Hardware in the U.S., you can always expect unprecedented expertise, value, quality, service and reliability.



- Wire Rope, Cable, & Strand up to 6" Diameter
- Grade 30, 43, 70, 80, 100 Chain
- Wire Rope Hardware, Fittings & Accessories
- Chain Hardware, Fittings & Accessories
- Tie Downs & Related Hardware
- Blocks & Accessories
- Bright, Galvanized & Stainless Steel

#### EXECUTIVE OFFICE

9445 S.W. 40 Street, Second Floor  
Miami, FL 33165  
P. 305.262.3105 F. 305.262.2094

#### TAMPA WAREHOUSE

603 N. 19 Street  
Tampa, FL 33605  
P. 813.247.2094 F. 813.248.2821

#### HOUSTON WAREHOUSE

2003 Edwards Street  
Houston, TX 77007  
P. 713.861.4203 F. 713.861.4280

#### NEXT DAY DELIVERY

1-800-458-6659  
[www.elitesalesinc.com](http://www.elitesalesinc.com)



**ELITE SALES Inc.**

Drahtseilwerk  
Bremerhaven



# Thinking Plastic Fasteners?

Choose the world's premier manufacturer of quality plastic fasteners.



**microplastics.com**

800.466.1467

# REMFORM<sup>®</sup> Screws.

Designed for Plastic Applications.



Now Specified  
in Ford  
Worldwide  
Fastener  
Standards!

The REMFORM<sup>®</sup> Screw is a thread rolling fastener with a unique thread form to provide superior performance in today's wide range of plastics. The asymmetrical thread minimizes radial hoop stress to reduce boss bursting. The narrow tip angle also reduces stress in the plastic nut member.

Email us now for a *FREE* engineering guide at: [sales@holbrookinc.com](mailto:sales@holbrookinc.com).

**HOLBROOK** MFG., INC.

288 Holbrook Drive • Wheeling, IL 60090 • Phone (847) 229-1999 • Fax (847) 229-0996  
Email: [sales@holbrookinc.com](mailto:sales@holbrookinc.com) • Internet [www.holbrookinc.com](http://www.holbrookinc.com)

ISO 9001:2008

REMFORM<sup>®</sup> is a registered trademark licensed by Research Engineering & Manufacturing, Inc.



# Rivets • Inserts Lockbolts

#1 Factory Authorized Distributor Of Top U.S.A. Brand Fastening & Installation Systems

**Avdel®**  
Speed Fastening Experts  
All Avdel Tools & Fasteners

Rivcrew • Avtronic  
Briv • Chobert

**HUCK**

All Huck Tools & Lockbolts  
940 Power Rig Kits

**POP®**  
All POP Fasteners & Tooling

PRG510A Proset PRG540 Models



Leading  
VMI  
Logistics  
Partner

**Call Toll Free: 800-718-8818**

Factory  
Authorized  
Service  
Center

Rivets	Inserts	Lockbolts
<ul style="list-style-type: none"> <li>Blind Rivets</li> <li>Mate Rivets</li> <li>Bulbex/LSR</li> <li>Monobolt Style</li> <li>Magnalok/Interlock</li> <li>Bulbtite/Shave-Head</li> <li>Hucklok</li> <li>Special Finish</li> </ul>	<ul style="list-style-type: none"> <li>Threaded Inserts</li> <li>Rivet Nuts</li> <li>Nutserts</li> <li>Hex &amp; Square Body</li> <li>Wellnut Style Inserts</li> <li>Jacknut Inserts/Tools</li> <li>Coil Thread Inserts/Tools</li> <li>AVK Inserts (A-L A-K A-H A-T)</li> </ul>	<ul style="list-style-type: none"> <li>Huck C6L/C50L/HP8</li> <li>Magnagrip</li> <li>Avdelock</li> <li>Maxlok</li> <li>Hucktainer</li> <li>Avtainer</li> <li>Bobtail &amp; Huckspin</li> <li>BOM/Avbolt Blind Bolts</li> </ul>



**50  
YEARS**

Since 1962 Bay Fastening Systems has been known as "THE" Distributor's resource for all top domestic brand engineered fastening and installation systems worldwide.



263 Park Ave., Garden City Park, NY 11040

[www.bayfastening.com](http://www.bayfastening.com) • [info@bayfastening.com](mailto:info@bayfastening.com) • Local: 516.294.4100 • Fax: 516.294.3448



**NEW \* NEW \* NEW**

**Submit your industry news  
online with our brand new  
Press Release Upload Tool!  
Find the big red button at  
[www.linkmagazine.com](http://www.linkmagazine.com)**



- 124 Copper State Celebrates 40 Years!
- 126 Fastener Crossword Puzzle
- 135 All American Fastener Show
- 138 Eurolink Fastener Supply: Citizens in a Global Economy
- 140 MAFDA Annual Golf & Scholarship Classic
- 141 American Imperial is BUMAX Approved!
- 146 The NCFA Turns 30!
- 149 Peterson Spring Introduces Their Specialty Products Division
- 156 Subscription Form
- 158 NEFDA 2012 Scholarship Golf Outing  
*Peter Wisk*
- 162 MFDA Awards \$18,000 in Scholarships  
*Barb Traum*
- 164 MWFA Golf Outing and Banquet Photos
- 167 Field Fastener Makes INC 500/5000 for 2nd Consecutive Year
- 171 Rumco Fasteners: Securing Your Products for Over 25 Years
- 184 Fastener Website Advertisements
- 187 Quantum Storage: An Industry First
- 208 NEFDA Scholarship Golf Outing Photos
- 209 WIFI Offers Scholarship & Mentoring
- 214 NEFDA Board Member Election Photos
- 222 MFDA Scholarship Awards Photos
- 232 NEFDA Scholarship Golf Outing Photos
- 244 Sales Training Tips from the Trenches  
*John Boe*
- 246 Just Listen  
*Dave Kahle*
- 250 IFI Tech Update 2Q 2012  
*Joe Greenslade*
- 251 Puzzle Solutions

**Leo J. Coar**  
Editor/Publisher  
[leoicoar@linkmagazine.com](mailto:leoicoar@linkmagazine.com)



**Maryann Marzocchi**  
Vice-President/Advertising Sales  
[maryann@linkmagazine.com](mailto:maryann@linkmagazine.com)



**Tracey Lumia**  
Director, Sales and Marketing  
[tracey@linkmagazine.com](mailto:tracey@linkmagazine.com)



Distributor's Link Magazine is a quarterly publication dedicated to the Fastener Industry and Fastener Distributors.

**Address all Advertising Materials & Correspondence to:  
DISTRIBUTOR'S LINK INC.**

**4297 Corporate Square · Naples · FL 34104**

**Phone: 1.800.356.1639 or 239.643.2713**

**Fax: 239.643.5220 · [www.linkmagazine.com](http://www.linkmagazine.com)**

All rights reserved. No part of this publication may be reproduced without permission of the publisher. Subscription price: \$50 USA, \$60 Canada, \$70 all others. Editorial reprints available upon request. Inquire about charges. *Publisher's Notice:* Distributor's Link Magazine assumes no responsibility for validity of claims in connection with items appearing in our magazine.

**PUBLICATION DESIGN & LAYOUT PRODUCED BY:**  
phone 224.489.9533 email [info@graphikacreative.com](mailto:info@graphikacreative.com)  
[www.graphikacreative.com](http://www.graphikacreative.com)

**GRAPHIKA**  
CREATIVE

**SPECIAL THANKS TO [GLOBALFASTENERNEWS.COM](http://GLOBALFASTENERNEWS.COM) FOR SEVERAL NEWS PIECES IN THIS ISSUE**

# DISTRIBUTOR NEWS

The management of **Telefast Industries Inc.** is pleased to announce that effective June 1, 2012, Telefast is listed as an approved manufacturer for Class 3 Threaded Fasteners by the Defense Logistics Agency. Telefast will now be placed on the QSLM Lists for both Class 2 and Class 3 Fasteners.

Located in Berea, Ohio, Telefast is a domestic manufacturer of various types of fasteners including nuts, hex head cap screws and cold headed specials.

For more information contact Telefast Industries Inc. 777 West Bagley Road, Berea, OH 44017 USA, Tel: 440-826-0011, email: sales@telefast.com or visit their website at [www.telefast.com](http://www.telefast.com).

## OBITUARY

Ruth Young, 80, who owned and operated Tidewater Industrial Fasteners in Norfolk, VA, from 1963 to 1989, died June 9, 2012. She was proud to be the first woman board member of the National Fasteners Distributors Association.

Survivors include her husband of 27 years, Gene Young; children, Terence Konrad, Melony Cheshire, Barton Walz and Kathleen Vaughan; five grandchildren and four great-grandchildren.

**Brighton Best International Inc.** is relocating its Chicago facility later this year to a 257,542-sq ft industrial building in the I-88 industrial submarket,

The new branch will be at 940 N. Enterprise St., Aurora, IL 60504.

Brighton Best signed a long-term lease for the entire building, Duke Realty announced.

Built in 1998, the building has 30-foot clear height, 40-by-40-ft column spacing, 36 truck docks, and four drive-in doors.

Brighton-Best distributes fasteners through 31 warehouses in the U.S., Canada, UK, Brazil, Australia and New Zealand and is headquartered in Tainan, Taiwan.

For more information contact BBI at 5855 Obispo Ave., Long Beach, CA 90805-3715. Tel: 562-808-8000 or visit them on the web at [www.brightonbest.com](http://www.brightonbest.com).

**Industrial Rivet & Fastener Co.** a global manufacturer, distributor and importer of quality rivets and fasteners, has launched a new website: [www.rivetwear.com](http://www.rivetwear.com), which offers branded merchandise featuring the well-known RivetKing® logo.



“Over the years, our customers have had many requests for hats, t-shirts and other merchandise with the RivetKing logo,” commented Joanne Goodman Sherman, Secretary/Treasurer of Industrial Rivet. “As part of our 100th Anniversary celebration, we are opening an online store that offers merchandise that will be both practical and fits with the lifestyle of our customers.” Visitors to the website will be able to purchase a variety of merchandise including: hats, golf shirts, duffel bags, mugs and jackets.

In addition to the launch of [www.rivetwear.com](http://www.rivetwear.com), Industrial Rivet is also celebrating its 100th Anniversary by giving away custom-designed t-shirts (one per customer) in a variety of colors and sizes, which are available on Industrial Rivet’s website. To order a t-shirt, simply visit [www.rivet.com](http://www.rivet.com) and click on the 100th Anniversary banner to place an order.

Established by Willie Goodman in 1912, Industrial Rivet was founded on a set of core values that have remained the cornerstone of the company’s philosophy throughout the decades – to deliver exemplary service, a superior product set, ongoing innovation and unmatched quality to its customers. The company is now in its fourth generation as a family-held business – a rare occurrence in business these days.

Industrial Rivet & Fastener’s duffel bags, mugs, golf shirts and other lifestyle merchandise are featured on the website [www.rivetwear.com](http://www.rivetwear.com).



# 40

YEARS OF DISTRIBUTING EXCELLENCE

VISIT US AT BOOTH 1103

# Tower of Power

## Advance Components

is a master stocking distributor of A Raymond Tinnerman products, offering our customers the best heavy duty/high torque application fasteners.



**Advance  
Components**

The Distributor's Source for

 **ARaymond TINNERMAN**  
MORE THAN FASTENING



AR TINNERMAN MULTI THREAD U NUTS

[advancecomponents.com](http://advancecomponents.com) 972.446.5500

Engineering Support Fast Shipping Extensive Inventory



## Bengt Blendulf

Bengt Blendulf is president/principal lecturer of EduPro US, Inc. Educated in Sweden, he moved to the United States in 1974 to start a subsidiary for a Swedish fastener manufacturer. Bengt also served for eight years on the faculty in the College of Engineering and Science at Clemson University. Since 1997 he (EduPro) teaches highly rated courses in Fastener Technology and Bolted/Screwed Joint Design in the U.S., Canada, Mexico, Europe, Asia and India, for engineers and other fastener professionals. Bengt was the chairman of ASTM F16.96 Bolting Technology from 1996 to 2006. In 2006 he received the Fred F. Weingruber award from ASTM for "his efforts to promote and develop standards for the fastener industry." He is the author of an extensive lecture book as well as over 100 technical papers and articles. His business address is: EduPro US, Inc., PO Box 232, Alameda, CA 94501; phone 510-316-3234; email: bengt@edupro.us; web: www.edupro.us.

## DIN – A DIN-OSAUR?

Ever since the American manufacturing industries, including automotive, started using some metric designs in the mid-1970's, or when metric spare parts were needed for imported equipment (machinery, power equipment, automobiles, etc.) the German DIN standards has been the rule in the United States. DIN (Deutsches Institut für Normung) had its origin as NADI (Standardization Committee of German Industry) in 1917, but changed to DIN in 1975. The DIN standards have strongly dominated Europe and the rest of the metric world for almost a whole century. The US engineering societies (ASME 1880, ASTM 1898 and SAE 1905) have represented the inch/pound world (the British BSI to a smaller degree) also for about a century.

When metric standard fasteners were initially ordered by general user industries and MRO customers, the primary suppliers were, and still are, fastener distributors/importers. The only standards of practical use for specifying metric fasteners were primarily DIN and, to a much smaller degree (for machine screws) the Japanese JIS. All product catalogues from the suppliers of metric fasteners included primarily DIN references. That same information, of course, was also used by the customers (the fastener using industries) since it was the only common standard commercially available.

### ISO

To make it easier for all industrialized countries to share common standards for industrial components, Technical Committee 2 of ISO (ISO TC 2) developed and published, starting in the 1970's, international standards for most metric fasteners. Since the DIN standards for metric fasteners had been around and thoroughly tested for a long time, it was only natural that DIN became the original base for the ISO metric fastener standards.

### Enter OMFS

The Optimum Metric Fastener System was the US "answer" to the German DIN standards. The US automotive and fastener industries felt the need to scrutinize the perceived soundness of the DIN standards. Perhaps the feeling was that the Germans had invented a pretty "round wheel" but we could possibly make it rounder! Anyway, the resulting technical research eventually lead to a series of ASME B18-standards (actually called ANSI standards most of the time). These ASME standards for Hexagonal fasteners (in particular) had the looks of the DIN-based ISO standards, but were usually attached with a phrase concerning interchangeability.



*For example: ASME B18.2.3.1M states in section 2.1:*

"Hex Cap Screws, sizes M5 to M64, as presented in this standard are harmonized to the extent possible with ISO 4014 and for short screws threaded full length, with ISO 4017. Dimensional differences between this standard and ISO 4014 or ISO 4017 are few, relatively minor, and none will affect the functional interchangeability of screws manufactured to the requirements of either."

*This is nothing but TECHNICAL TRADE OBSTACLES developed by a group of good, well meaning engineers with little or no understanding of commercial realities!*

If, in fact, there are dimensional differences between ISO and ASME (and there is) will the receiving inspectors care about "functional interchangeability" or just go on the tolerances for the lot ordered. For example, ASME allows wider length tolerances than ISO in many cases.

With this unfortunate mixture of all published fastener standards for metric it is no wonder that the commercial market is still stuck on the older (and mainly obsolete) DIN fastener standards.

We have this metric bolt and

# 50,000 OTHERS

as well to meet your specific needs.

From its brand new, state-of-the-art distribution facility located in Columbus, Ohio. Metric Fasteners Corporation is specialized in metric fasteners for resellers and distributors operating in the North American market only. In addition to offering professional customer service, we guarantee:

- Competitive prices
- Wide variety of sizes and materials (incl. Stainless Steel A2 & A4)
- High Quality Standards
- Full lot and batch traceability
- E-business solutions

Contact our experts now and setup your online account on **[www.metricfastenerscorp.com](http://www.metricfastenerscorp.com)** and receive an additional 5% discount.

Metric Fasteners Corp.  
2833 Charter Street  
Columbus, OH 43228-4607  
Tel: 877-425-7611 (Toll free)  
Fax: 614-777-7614  
[info@metricfastenerscorp.com](mailto:info@metricfastenerscorp.com)  
[www.metricfastenerscorp.com](http://www.metricfastenerscorp.com)





## Robert B. Footlik

Robert B. Footlik is a licensed professional engineer. A graduate of Illinois Institute of Technology, he has worked extensively in the fields of material handling, plant layout, packaging and management systems. The firm of Footlik and Associates serves as staff warehousing and materials consultants to six trade associations. Footlik writes for 12 trade and professional journals. Footlik and Associates is located at 2521 Gross Point Road, Evanston, Illinois 60601; phone 847-328-5644.

## IF YOU REALLY TRUST THE WAREHOUSE (PART 2 of 2)

In the Summer 2012 issue of Link Magazine my article "If You Really Trust the Warehouse" built on an article published in the same magazine "Is It Time for Warehouse Incentives?" Both presented the rationale for building trust with everyone involved with your business (staff, vendors, customers) and achieving a "comfort level" with standards for accuracy, productivity and communication. This article addresses the more practical side of successful implementation of a program that everyone embraces.

### Personnel Issues

No matter how well designed and intentioned a quality based effort ultimately success comes from the people involved. If you cannot trust the individuals to perform properly and respond to your program then there really is no point in even staying in business. More Supply Houses fail from poor personnel selection and training than from any other internal or external forces.

A key point of initiating a Statistical Sampling process is to identify the weak links due to ineffective people and processes. By collecting trustworthy data it becomes a relatively simple matter to turn the numbers into solid information. A simple example would be tracking picking errors and discovering that 90 per cent of the problems can be attributed to one individual. Clearly this makes a case for retraining, retasking or terminating the sub performing staff member. Similarly if everyone is making the same mistake a properly designed and implemented training program is often the best solution.

Hiring the right people initially makes the most sense. We have even known a Distributor who fired everyone in the warehouse and started over after a random drug test

proved what he suspected. While not advocating anything this drastic it is important to insure that new hires are acceptable in your context.

With the Statistical Sampling in place new hires should become pickers where their output can easily be inspected. This might initially mean a 100% inspection on every order prior to the carton being sealed and at the same 4% random inspection of sealed orders. It is never enough to check and correct. Data that is

collected and recorded should be regularly examined, especially during and immediately after a 30 day probationary period. Elimination of marginal performer during the first 30 days saves a lot of future aggravation.

When implementing a "Pick/Pack" program packers are usually the best candidates for repurposing. They already know how to "build a box" for the best packing job. In addition they should be able to achieve greater success in choosing what size box to fill. The first pick/packers train the others and act as the lead "go to" resource. This adds an element of learning and teaching with the first initiators taking ownership of the program.

Emphasize that the pick/packer's job is to keep moving and finishing orders. Everyone else in the operation is there to support them. If product is not on the shelf for any reason it slows down the operation. As other warehouse staff members rotate into this position (and everyone should) they will have a better understanding of their supporting roles. With training and encouragement stockers should be looking for shelves with low inventory levels to restock long before a picker arrives. This changes their perspective as well as their job description. Obviously if the WMS can be used to direct these activities it simplifies the process.





# NORTH EAST FASTENERS

Commercial | Military | Aerospace | Automotive | Specials

## No matter how close you look, nobody looks better. *(even in fine print)*

honesty, great  
value, reliable partner,  
quality, superior knowledge,  
situational awareness, versatility  
organization, passion, dependable  
meticulous attention to detail,  
responsive customer focus,  
product assurance, rapid  
integrity, continuous  
improvement process  
solutions.

**NEF is an ISO 9001:2008 & AS9100C QSLM Levels 2/3 certified manufacturer.**

**Size range:** (Inches) 00 to 10 and (Metric) M1.2 to M5, up to 2 Inches (or 50mm) in length.

**Specifications:** IFI, ANSI, MS, NAS, NASM, AN DIN, JIS, JCIS, ISO, QSLM, DFAR, ROHS; and Specials.

**Licensed drives:** ACR® Phillips II and Phillips Square Drive® II, Mortorq®, Mortorq® Super, ACR® Phillips, ACR Torq-set®, Torq-set®, Tri-Wing® all of which are registered trademarks of the Phillips Screw Company.

North East Fasteners Corporation • 8 Tremco Drive, Terryville, CT 06786  
Toll Free: 800.630.4770 Phone: 860.589.3243 Fax: 860.589.6969 E-mail: nef@nefl.com

By Jason Sandefur  
 editor@globalfastenernews.com

## US FASTENER DEMAND A BRIGHT SPOT IN THE GLOBAL ECONOMY

As economic uncertainty continues in Europe and economies in Asia start to slow, many fastener companies are finding relatively strong demand in North America.

This trend is demonstrated by recent sales and earnings releases analyzed by GlobalFastenerNews.com.

While Bossard Group's overall revenue fell by 0.4% in the opening six months of 2012, sales in the U.S. gained 13.2% — including a 22% jump in the second quarter — at a time when European sales fell 5% and Asian revenue declined 5.5%.

"Whereas America reported double-digit sales growth, customer demand in Europe and Asia was in line with the declining Purchasing Managers Indices," the company stated.

Grainger saw U.S. sales in the first half of 2012 gain 8.8%, with sales in Canada growing 9%. Grainger also found 21% organic growth overseas, primarily spurred by disaster recovery in Japan.

Anixter's OEM Supply segment, including fasteners, said six-month revenue grew 5% in the U.S., while Europe achieved a 5.1% increase and Emerging Market (Asia Pacific and Latin America) sales soared 30.6%.

The Würth Group said sales in the company's home country of Germany increased 4.5% during the first half of 2012. Würth operations in North America grew "above average," resulting in a 22.9% sales gain to \$588.5 million. Sales in South America improved 7.6%.

ITW organic revenues grew 2.3%, with North American organic revenues increasing 5.3% and international organic revenues declining 0.8%. European organic revenues decreased 1.7%. Asia Pacific organic revenues "underperformed company expectations,"

growing only 1.8%.

Notably, China organic revenues declined 0.5%.

### *Fastenal In the Blue-Black*

Fastenal Co. reported net sales grew 14.7% to \$804.9 million in the second quarter of 2012, hampered by a slowdown in the industrial production market during the period. Pre-tax earnings gained 19.2% to \$179 million, while net earnings climbed 19.3% to \$112.3 million.

Fastenal said its end-market growth rate slowed to 15.8% in Q2, down from 20.3% in the previous quarter, which was slightly higher than the 20% rate of end-market growth the company experienced in 2011.

"In the first three months of 2012, the daily sales growth in our fastener product line was approximately 15.4%. This dropped to 10.5%, 6.1%, and 8.6% in April, May, and June, respectively."

Six-month sales gained 17.2% to \$1.57 billion, with pre-tax earnings up 22% to \$340.2 million and net earnings up 22.4% to \$212.5 million.

Vending machine installations are soaring in 2012, driving sales and earnings gains. The company installed 3,238 new machines in Q2, driving its six-month vending machine growth rate up 75% to 13,036. Daily sales growth to vending machine customers rose 34.3% in Q2.

In the first half of 2012 Fastenal opened 53 stores, bringing its total to 2,635. It increased its workforce 2.7% to 15,578 employees.

please turn  
 to page 182





SINCE 1963

# METRIC & MULTISTANDARD COMPONENTS CORP.

*The Distributor's Master Stocking Metric Resource*

**FASTENERS  
WRENCHES**

**FITTINGS  
TUBING**

**CUTTING TOOLS  
MEASURING TOOLS**

**ASSORTMENTS & SETS  
SPECIALTY ITEMS**

The #1 Distributor Program  
**VOLUMETRICS<sup>SM</sup>**  
Volume Savings,  
Private Brand Labeling & more!  
Only for Distributors  
**CALL NOW!**



**www.METRICMCC.com**

**888-966-6622**

**NEW YORK**  
800-431-2792

**GEORGIA**  
800-444-9560

**ILLINOIS**  
800-221-4469

**TEXAS**  
800-527-5177

**NEVADA**  
800-786-4599



**ISO 9001:2008 CERTIFIED**

MWFA - P. O. Box 5, Lake Zurich, IL 60047 • Tel: 847.438.8338 • 1.800.753.8338 • Email: mwfa@ameritech.net • www.mwfa.net

## MID-WEST FASTENER ASSOCIATION

# MWFA's 31st ANNUAL FASTENER SHOW & 60th GOLF OUTING HUGE SUCCESSES

The economy has prevented our industry from inventory over stocking, personnel hires, investing in events and more. But this past June proved to be a good investment for many industry personnel as they participated in the MWFA Fastener Show and Golf Outing. The MWFA alternates between a Table Top Show and Fastener Tech Shows. This year's Table Top, at Medinah Banquets in Addison, IL, featured 109 exhibits featuring manufacturers, service industries, secondary services and more. With nearly 300 attendees visiting the show and 200 exhibit registrants, the show entertained nearly 500 industry personnel throughout the day. The Show was followed by a two hour Fastener Bash which included plenty of drinks, food, a photo booth and most of all great networking in a relaxed atmosphere at Eaglewood Golf Resort.

President Matt Delawder (SWD Inc.) states "Rich Cavoto (Vice President) and I made sure that at least one of us had an opportunity to visit each exhibit, not only to thank them but to listen to any concerns, thoughts, suggestions etc. I received so many positive comments that it made me proud of our whole Board for making it come together. We are trying to reach out to everyone involved in our industry to make sure everyone has a voice. The group of people that make up the MWFA Board of Directors is as diverse as our industry, which is a real strength to our organization. Sometimes in a slower economy one needs to direct people to the positives, this year I enjoyed the positives coming from the participants over the two days of events."

### Exhibitors:

3M Electrical Markets Div.  
3Q Inc.  
Abbott-Interfast  
Acme Companies  
Advance Components  
Alfa Tools  
All American Washer Werks  
All Special Fasteners  
Allstar Fasteners  
American Fasteners & Components  
American Pride



Anderson Mfg.  
Andre Corp.  
Automation Systems  
Aztech Locknut  
Company, Inc.  
Beacon Fasteners &  
Components  
Big Bolt Corp.  
Bossard Metrics Inc.  
Bradley Adhesive  
Technologies

Brighton-Best Int'l  
Brikksen  
Cable Tie Express  
Career Place  
Carpenter Technology  
Chicago Hardware & Fixture Co.  
Computer Insights  
Continental-Aero  
CSM Fastener Products  
Delta Secondary  
Distributor's Link Magazine  
DLP Coatings, Inc.

Dynacast Industrial Products  
Elgin Fastener Group  
Enthone Inc.  
EZ Sockets Inc.  
Fall River Manufacturing  
Fastener Technology Int'l  
FastenersClearingHouse.com  
Fastron Co.  
Ford Fasteners  
Forest City Technologies  
G&W Technical Corp.  
Gaffney Bolt & Nut  
GlobalFastenerNews.com  
Hanger Bolt & Stud Co.  
Ifastgroupe  
Ifastgroupe/GFS  
Indusco Wire Rope & Fittings  
Industrial Rivet & Fastener Co. Inc.  
Innovative Components  
Integrated Packaging  
Intercorp  
INxSQL Software  
J&M Plating Inc.  
Kanebridge Corp.  
KDS Imports  
LEP Special Fasteners  
Lindstrom Metric, LLC  
Locknut Technology  
Marli Mfg.

please turn to page 116



# **BUILD YOUR REPUTATION FOR QUALITY ON THE STRENGTH OF FORD 410 STAINLESS STEEL SCREWS.**



## **410 STAINLESS STEEL SCREWS**

**SHEET METAL • SELF-DRILLERS  
THREAD CUTTERS • SELF-PIERCING**

When common screws just won't do, turn to the strength of Ford's 410 stainless steel screws.

Discover a range of 410 stainless steel screws to size up any application perfectly with every kind of 410 stainless steel screw imaginable at your fingertips for immediate delivery.

For over 40 years, with 25 years of manufacturing and selling experience, Ford can engineer and produce fasteners to any requirement.

Our stainless reputation for long-lasting quality is built on the strength of versatility in our superior line of Ford 410 stainless steel screws.



**Ford Fasteners, Inc.**

110 SOUTH NEWMAN ST., HACKENSACK, NJ 07601  
201-487-3151 • FAX: 201-487-1919 • [www.fordfasteners.com](http://www.fordfasteners.com)

**NEW JERSEY / ATLANTA / DALLAS**

**CALL FORD FOR 410 • 1-800-272-3673**



**20** Years  
Strong  
1992-2012



**VoltPlastics.com**



**Made in  
the USA**  
Yellville, Arkansas

# 20th Anniversary of Plastic Fastener Manufacturing



When Joe Volltrauer came to the U.S. from Austria in 1952, the teenager couldn't have dreamed that one day he'd be the President and Chief Executive Officer of one of the world's largest plastic fastener manufacturers.

The company founded in 1992 by Volltrauer, Volt Industrial Plastics (V.I.P.), recently celebrated 20 years in the plastic fastener manufacturing industry with an anniversary party held at the company's Yellville, Arkansas facility. The twenty year milestone

was celebrated by employees, customers, and friends on June 1, 2012. The festivities included a company picnic, flag raising ceremony, and addresses by company founder, Joe Volltrauer and Chief Operating Officer Heidi Volltrauer-Skiver.

*(continued on page 18)*

Pictured from left to right: Volt employees enjoying the 20th Anniversary celebration. • Many long-time friends dropped by the 20th Anniversary celebration to honor the Volltrauer family. Pictured with mascot Sophia are (left to right) Jodie Elizabeth Jeffrey, Tom Schmuecker, and Ann Schmuecker. • Ashton McManness preparing to enter the hot dog line. • The company picnic gave everyone a chance to enjoy some good food and time together. • Ran Branaman enjoying the company picnic with co-workers and family. • Company President, Joe Volltrauer, visiting with his father Joseph Volltrauer, Sr.

## 20 Years of Fastener Manufacturing

Page 18: Manufacturing History Spans 60 Years

Page 20: Meeting the Challenges

Page 22: Our New Location

Page 132: Proudly American Made

Page 134: Planning for a Successful Future

Page 136: Serving Clients Worldwide



## Manufacturing History Spans 60 Years

The company's history actually begins much earlier than 1992. The foundation for the manufacturing business was laid forty years earlier, in 1952, when Joe Volltrauer came to the U.S. from Vienna, Austria.

Joe got a job as an apprentice tool and die maker for Acme Tool & Die in Chicago. He particularly loved the challenge of mold making. "It's like an artist sculpting," he explained.

In 1973 he started his own company, JV Tool. For its customers, JV Tool was a problem solver, a quality improver, a cost saver.

A few years later, Joe Volltrauer relocated his business and family to northern

Arkansas where he designed high-quality molds for manufacturers of plastic components, including plastic fastener makers in the region. In 1992, Mr. Volltrauer put his mold and tool making experience in the plastic fastener industry to work and founded Volt Industrial Plastics.

*(continued on page 20)*



Pictured from top to bottom, left to right: Volt Industrial Plastics Founder, Joe Volltrauer, (seated) with wife, Erwine (standing far right) and daughters (standing left to right) Heidi, Brigitte and Helga • Company founder Joe Volltrauer in 1992, the year V.I.P. was established • J.V. Tool, established in 1973, laid the groundwork for the plastic fastener operation. • Volt's original manufacturing facility located in Flippin, Arkansas • Heidi and Joe Volltrauer pictured in 2000 • Joe Volltrauer working with long-time Tool Room Manager, Jesse Patterson.

# The BUSINESS EDGE 2.0

*The Best Software for Tracking your Fasteners*



**The Best Deal in Vegas is Back!  
Win a BUSINESS EDGE 2.0 System**



*With Real Time Supply Chain Integration*

**Brighton-Best Connection**

**COMPUTER INSIGHTS PROMISES TO MAKE THE 2012 VEGAS SHOW BIGGER & BETTER!**

**1**

**FREE System!**

Fill out a brief survey online to be entered to win a complete The BUSINESS EDGE system. Contact us for more info, scan the code, or visit [www.ci-inc.com/vegaslink](http://www.ci-inc.com/vegaslink)



**FREE iPad 3!**

Place your order for a BUSINESS EDGE System at our BOOTH 1018 and receive a FREE iPad 3 as our way to say thank you!



**2**

*more*

Computer Insights Inc • [www.ci-inc.com](http://www.ci-inc.com) • 800.539.1233

simple • focused • effective

## 20 Years of Fastener Manufacturing

Page 18: Manufacturing History Spans 60 Years

**Page 20: Meeting the Challenges**

Page 22: Our New Location

Page 132: Proudly American Made

Page 134: Planning for a Successful Future

Page 136: Serving Clients Worldwide



## Meeting the Challenges

The plastics manufacturing industry has evolved since the company was founded twenty years ago. Throughout the company's history, Joe Volltrauer reinvested profits back into V.I.P. with the purchase of state-of-the-art equipment and facility upgrades to ensure the company remained competitive in the global marketplace.

At a time when many companies were struggling during the recent economic recession, Volt Industrial Plastics experienced growth. Responding to the increased demand for V.I.P.'s competitively priced, quality plastic fasteners, the company relocated their manufacturing operations to a newly-renovated 65,000 square foot facility in 2011.

*(continued on page 22)*



Pictured from top to bottom, left to right: Volt's in-house CNC Department provides a quick turn-around for custom orders. The new addition of Mitsubishi EDM machines makes the process even smoother. • Volt's Threaded Rod Department allows the flexibility for in-house threading for customer orders. • Toolmaker hard at work • Ran Branaman operating one of many tapping machines in V.I.P.'s Secondary Operations.

# The Best Hand In The House!

*The action is with ND Industries,  
a leading manufacturer and processor of  
fastener locking and sealing materials.*



We'll be at Booth #406 of the 2012 National Industrial Fastener & Mill Supply Expo, October 11th & 12th, in Las Vegas, Nevada



**Advanced Fastening and Sealing Technologies**

[www.ndindustries.com](http://www.ndindustries.com) • [products@ndindustries.com](mailto:products@ndindustries.com)

ND Industries, Inc. USA Processing Facilities: New Jersey

North Carolina • Michigan • Ohio • Illinois • Texas • California



## 20 Years of Fastener Manufacturing

Page 18: Manufacturing History Spans 60 Years

Page 20: Meeting the Challenges

**Page 22: Our New Location**

Page 132: Proudly American Made

Page 134: Planning for a Successful Future

Page 136: Serving Clients Worldwide



## Our New Location

The new location is over two and one half times larger than the previous facility and includes additional warehouse space for raw materials and a finished goods warehouse of approximately one billion plastic fasteners, allowing for same day or next day shipping to customers. The additional manufacturing space in the new facility houses the latest state-of-the-art tool making and production equipment including EDM machines, top-of-the-line CNC-EDM sinker, a CNC milling center and a CNC lathe. V.I.P.'s on-site tooling allows for quick production of custom orders based on specific customer applications.

Tool Department Manager Jesse Patterson explains,

***“We often analyze, recommend, quote and have prototypes on the way while competitors are still coming up with a price.”***

*(continued on page 132)*



Pictured from top to bottom, left to right: V.I.P.'s Production Floor includes a total of 22 machines including one 22-ton machine, two 55-ton machines, and nineteen 28-ton machines. • Volt's Product Warehouse allows for a billion-part inventory. Megan Oxford pulls a customer order that ships the same day. • Volt's Shipping Department works hard to ensure orders are fulfilled and shipped on-time, so customers can count on receiving the parts they need, when they need them. • V.I.P.'s Tool Set Up Department gives Volt an advantage by allowing on-site custom tooling for all types of fastener products.



# KEN FORGING

Forged Industrial Hardware



## Carbon • Alloy • Stainless

- Eyebolts
- Nut Eyebolts
- Turnbuckles & Fittings
- Rod Ends
- Eye Nuts
- Pad Eyes
- Strap Clamps
- T-Slot Nuts
- Set-Up Wedges
- C-Clamps & Screws
- D-Rings & Clips
- Swivel Hoist Rings
- Custom Forgings - Up to 200 lbs.
- In Stock



All Products Proudly  
Made in The USA

**Toll-Free: 888-KEN-FORGING (536-3674)**

Phone: 440-993-8091 • Fax: 440-992-0360

www.KenForging.com • E-mail: sales@kenforging.com



## Guy Avellon

Guy Avellon has been in the MRO and fastener distribution industry for over 30 years. He began his metallurgical engineering career at Republic Steel Research Center in metal coatings and has since held positions as sales engineer; Chief Engineer; Manager of Product Marketing, Product Engineering and Quality and Director of Quality and Engineering. He founded GT Technical Consultants where he performs failure analysis, presents lectures on fastener safety, worked for law firms and designs and audits Quality systems.

He is a member of SAE and is Vice Chairman of the ASTM F16 Fastener Committee and Chairman of the F16.01 Test Methods Committee, since 1988. He also received the ASTM Award of Merit in 2005.

Guy and his wife, Linda currently reside in Lake Zurich, IL and may be reached at 847-477-5057 or visit his website at <http://www.BoltDoc.com>.

## ARE YOUR TEST DOCUMENTS ACCURATE? HAVE YOUR PRODUCTS BEEN FAIRLY REJECTED?

In the past decade, there have been many new fastener manufacturers from several emerging industrial nations entering the Global Market. Along with the manufacturers, new material testing laboratories have also begun to support their needs. While the manufacturers and testing facilities strive to meet the standard specifications established by the fastener industry, there is some confusion with the intent of the written standards.

Standards of any type that were written decades ago are now being questioned for clarity. This is because it was not anticipated that these standards would become Global Standards used by people whose first language is not English. However, there are also domestic materials testing labs who have been in business for years that are now beginning to test threaded fasteners and are testing them incorrectly or to the wrong specification. It is the intent of this article to help bridge this gap in understanding some of the meaning of test method requirements so that distributors may be assured of receiving the correct products and also understand why some of their products may be rejected by third party testing when they have been passed by others.

In the very early 1900s, the American Society for Testing and Materials (ASTM) was created to bring standards to industry. One of the first set of standards was for iron and steel products. Some bolting specifications were introduced in the 1930s for high temperature use (boilers and high pressure vessels), but all material testing verification was performed by machining round test specimens, as most fastener products at that time were large in diameter and tensile testing machines did

not have the capacity to test these large products.

The test standard A370 was written to test the raw material and the finished product. Test results produced not only Ultimate Tensile Strength, but Yield Strength, % Elongation and % Reduction of Area. All very useful data for material properties and design considerations, but not indicative of the performance specific for fasteners.

The ASTM F16.01 Committee on Test Methods developed F606/606M, unique to fasteners. More specifically, structural fasteners. These fasteners were

to be tested full sized, as a finished product, not machined. Later, non-structural and smaller diameter products were added, such as with the SAE (Society of Automotive Engineers) J429, which specified fasteners in sizes below 1/2" that are too small to machine.

In the spirit of commonality, the SAE has recommended using several ASTM test standards in their specifications and the A370 has adopted many of the procedures of the F606/606M in their standard. It should be noted that all of these testing standards are procedures only; 'how to perform the test'. These test methods do not invoke pass/fail limits or how to interpret the results. Only the applicable product specification has this information.



### Product Hardness

As noted in the test standard of F606, the procedure references ASTM E18, which specifies the method of calibration and use of a Rockwell Hardness machine. This process is assumed to have been observed before conducting the hardness test procedures of F606/606M on the product. If not observed, product could be incorrectly rejected.

# World Class Here at Home!

- ✓ HIGH QUALITY
- ✓ ISO 9002 CERTIFIED
- ✓ AGGRESSIVELY PRICED
- ✓ RAPID DELIVERY
- ✓ BEST OF ALL –  
MADE IN THE U.S.A.



Proudly manufactured  
in the U.S.A.

**IF** you've ever experienced problems with overseas sources or ISO compliance, you're not alone. We've all heard the horror stories that could have been avoided by ordering from a quality conscious, certified American manufacturer like Alpha Grainger Manufacturing.

You won't find a commitment to quality and customer satisfaction like Alpha Grainger's elsewhere on the planet. Achieving this level of satisfaction has not been simple. We have designed our own customized computer software and machine tools to create a one-of-a-kind, world-class manufacturing facility here in Massachusetts.

Long recognized as a leading producer of customized fasteners and hardware, Alpha Grainger Manufacturing also stocks a wide array of standard parts that are ready to ship and priced competitively.

Why search the world? Since 1973, Alpha Grainger has been providing the fastener industry with what it needs – consistently superior quality and competitive pricing.

**[508] 520-4005**  
Fax: (508) 520-4185 • [www.agmi.com](http://www.agmi.com)

Captive Panel Screws



Connector Hardware



Shoulder and Thumb Screws



Standoffs



**ALPHA  
GRAINGER**  
MANUFACTURING, INC.



# Dennis R. Cowhey

Dennis, R. Cowhey, started Computer Insights, Inc. in 1981 as is currently CEO. He served for many years on the Illinois CPA Society Computer Information Systems Committee. He is a frequent author of articles for Industry Trade Magazines. Before starting Computer Insights, he served as Central District Manager for a division of Litton Industries (now part of Northrup Grumman). That company offered Inventory Control Systems to Retailers. Prior to that, he was a Credit and Financial Analyst for National Credit Office division of Dun & Bradstreet, Inc. He received his education at Chicago City College and DePaul University.

## TECHNOLOGY HELPS WITH INVENTORY MANAGEMENT

### Fasteners are Difficult to Manage

Fastener inventory is one of the most difficult types of inventory to maintain. When we chose the fastener industry as our specialty, this was one of the main reasons. Fastener inventory is unique:

1. Many products are commodity products and need to be sent to several vendors for quote.
2. Some items are branded products and can only be purchased from one vendor. These need to be purchased directly without a request for quote.
3. Still other items require kitting or processing in order to be sold. These require a processing purchase order that creates demand for the components.
4. Components need to be requested for quote or ordered.
5. Many common products appear in multiple bills of material so potential shortages are easily missed.
6. Blanket orders are common and can often stretch out a year or more.

Code	Description	Available	Branch	Default Cost	Stoc
15128	MJ30400 HHCS 1E1800 DACRO	0	0	5.00	EA
15146	M30X350 HHCS 10 9 P&O	0	0	6.20	EA
15169	M30X700 HHCS 10 9 P&O	0	0	7.00	EA
15191	M30X620 HHCS 10 9 P&O	0	0	2.15	EA
16005	M36 HEX NUT CL 10 DIN970 P&O	0	0	0.91	EA
16205	1" 90 Street Elbows Galv Pipe Fittings	1,885	1,885	2.54	EA
16214	Magnetic Dr Hozer	450	0	0.2624	EA
16254	3/4 Caps Galv Pipe Fittings	3,347	3,347	1.71	EA
16730	Nylon Insulated Button Connector 22-18 Gauge	-50	-50	7.25	C
16730	Nylon Insulated Button Connector 16-14 Gauge	-100	-100	10.84	C
167970	Nylon Insulated Button Connector 12-10 Gauge	50	50	14.25	C
16901025	5/8 X 7-1/2 MC SPECIAL HEX BOLT GRADE 5 ZINC	0	0	1.00	EA
16901235	3/4 X 7-1/2 UNC HEX BOLT GRADE 5 ZINC	0	0	0.80	EA
17000100	440 X 5/16 Phillips Pan Sq cn Sem	92,700	0	0.0050	EA
170101	1 1/2-5 Q15 1/4 INZ	0	0	1.1514	EA
17251	#5-8 X 8 MM 6 Lobe (1-15) Truss Head	365,000	365,000	25.00	M
1770	1/4 Heat Treat Lock Washer	4,300	0	0.85	C
17745	1/8" X 1 1/2" Cotter Pins Zinc	165	165	0.020	EA
17906	#6 Hose Clamp SS	160	160	0.72	EA
17910	# 10 Hose Clamp SS	185	185	0.72	EA
18190	M27X27 SPL SSS P&O	0	0	0.96	EA
18197	M50 SPL HEX NUT CONTA-CLIP #25506 9	0	0	0.09	EA
18201	NPE 116-4ET PENN PCB Standoff	98,200	98,200	162.00	PK
18222	HCS 1/2-20 X 2 YZ GRADE 8	0	0	0.00	EA
18346	M12X1.5X35 SHC 12 9 P&O	0	0	0.00	EA
18365	SRK-6060-9 PEM KEYHOLE STANDOFF	0	0	0.00	EA
18436	5X11X1 WASHER BARKER #H2025 100 MM	0	0	0.00	EA
18453	8.74X25 4X6 HD WASHER 1E1675G 50 MM	0	0	0.00	EA
18573	71X140X1.5 SPL HD WASHER 13866	0	0	0.00	EA
18610	11X25X19HD WASHER 1E1675G BLK	0	0	0.00	EA
18617	11X25X19HD WASHER 1E1675G BLK	0	0	0.00	EA

### And That's Not All

Our clients often have as many as 100,000 products or more in inventory. The products look very similar and the part numbers are descriptive, so they are long and tedious to work with. Using purchasing reports for making buying decisions is problematic. By the time the purchasing agent gets through the entire report, many things have already changed because of the hectic pace of the business. Errors and omissions can easily

creep in and mistakes can be costly. This is an industry where you can easily turn a \$50 order into a \$500 mistake. Make that kind of mistake once too often and you will lose your customer.

### Even the Part Numbers are a Problem

Fasteners have more part numbers than centipedes have legs. A fastener could have any or all of the following:

1. A nomenclature part number
2. Several vendor part numbers
3. Several customer part numbers
4. A UPC code
5. Customer purchase order or purchase order line numbers or both
6. Customer end user package part numbers
7. Other miscellaneous part numbers, e.g. catalog numbers, sale numbers, etc.

Alternate	Description	Cust or Vend	Alt ID #
# 1000 786789-21	3/16-24 X 3/4 CARRIAGE BOLT PLA		85-600-7547
1024X 7500CBP	3/16-24 X 3/4 CARRIAGE BOLT PLA	C 407245 Dura Automotive / Ails	
12324	3/16-24 X 3/4 CARRIAGE BOLT PLA	V 224 ABRASIVE ACCESSORIE	
34982394-234324-3423-00	3/16-24 X 3/4 CARRIAGE BOLT PLA	C 1000 AA Manufacturing Co	
401-316A	3/16-24 X 3/4 CARRIAGE BOLT PLA	C 407246 Phezer Enterprises, Inc	
5843905-4324	3/16-24 X 3/4 CARRIAGE BOLT PLA	C 1148 C & C Metals	
62P24012	3/16-24 X 3/4 CARRIAGE BOLT PLA	C 407362 M	
6569	3/16-24 X 3/4 CARRIAGE BOLT PLA	C 407361 sci	200-1254-8546
9644889	3/16-24 X 3/4 CARRIAGE BOLT PLA		
903056	3/16-24 X 3/4 CARRIAGE BOLT PLA	V 195 PENN ENGINEERING	
AG-CBD 187-24X0 750	3/16-24 X 3/4 CARRIAGE BOLT PLA		
AN-212112	3/16-24 X 3/4 CARRIAGE BOLT PLA		
BB-CBD 187-24X0 750	3/16-24 X 3/4 CARRIAGE BOLT PLA		
HAG123	3/16-24 X 3/4 CARRIAGE BOLT PLA	C 407321 Haggerly Supplies, Inc	

### Automatic Replenishment to the Rescue

When it comes to inventory management, The BUSINESS EDGE 2.0 has the easiest to use and most sophisticated automatic replenishment system available for fastener companies. It is deceptively simple, yet it is remarkably comprehensive and it takes into account all of the nuances of handling fasteners. It saves many hours for the Purchasing Department and it virtually eliminates costly errors.

# W A S H E R S

Metal Stampings • Specialty Fasteners



## The MW Advantage:

- Over 35 years of experience
- Rush orders
- 1 ton to 500 ton capacity
- One of a kind & large quantities
- On-time delivery
- ISO 9001:2008 Certified

## The MW Website:

- Request quotes online
- Photo gallery & company videos
- Download brochure/newsletter

**National Industrial Fastener  
and Mill Supply Expo**

October 10-12, 2012

**Booth #1448**



2400 Farrell • Houston, Texas 77073

Tel 281-233-0448 • Fax 281-233-0449

Toll Free 800-875-3510

[sales@mwindustries.com](mailto:sales@mwindustries.com)

[www.mwindustries.com](http://www.mwindustries.com)





**Not Your Ordinary Screw**

**WE STOCK IT SO YOU CAN LOCK IT!**

**TAMPER-RESISTANT SECURITY SCREWS**  
**ALWAYS IN STOCK**  
**IMMEDIATE SHIPMENT**  
**PROUDLY MADE IN THE USA**

**SCREW & SUPPLY INC**  
**SECURITY FASTENER DIVISION**  
**DON'T SETTLE FOR ANYTHING LESS!**



1712 Church Street, Holbrook, NY 11741  
 Toll Free: 800-223-1316 or 631-567-2900 Fax: 631-567-3057  
 Email: [sales@screwssupply.com](mailto:sales@screwssupply.com) Web: [www.screwssupply.com](http://www.screwssupply.com)

## DISTRIBUTOR NEWS

**Micro Plastics** introduces a new line of Phillips Pan Machine Screws. Thread sizes included in this new line of screws are; 4-40, 6-32, 8-32 10-32, 1/4-20 and 1/4-28. Available in 25 standard lengths ranging from 3/32" up to 3".

The Phillips Pan Machine Screws are molded in tough, resilient and corrosion resistant Nylon 6/6 material.



Micro Plastics also offers an extensive line of machine screws include headstyles as Binder, Binder Combination, Fillister, Hex, Pan, Round, Socket, Flat, Oval and Thumb Screws, as well as Studs, Grubs and Flat Head Wing Screws.

Micro Plastics manufactures millions upon millions of fasteners daily. They offer over 20,000 items and maintain an inventory of over 250 million parts.

See their full line catalog #39 for a complete list of nylon fasteners that are available. FREE samples are available upon request. Contents include: standard and metric machine screws, cap screws, nuts, washers, spacers, insulators, grommets, bushings, rivets, hole plugs, clamps, printed circuit board accessories, suspended ceiling hooks, wire routing kits and many other hardware items.

For a FREE copy of the NEW full line catalog #39 contact: Micro Plastics Customer Service Department at P.O. Box 149, 111 Industry Lane, Flippin, AR 72634. Tel: 1-870-453-2261 Fax 1-870-453-8676, send an email to: [mpsales@microplastics.com](mailto:mpsales@microplastics.com) or visit their website at [www.microplastics.com](http://www.microplastics.com).

# LOCKNUTS



By  
**Lok-Mor**<sup>®</sup>  
 American Made Quality

## STANDARDS & SPECIALS • SPECIAL LIGHT OR HEAVY TORQUES

American, Standard and Metric • Plain, Zinc, Cadmium, & Other Platings  
 Steel Grades 2, 5 & 8, Stainless Steel, Monel, Brass, Bronze,  
 Aluminum Alloys & Other Materials

- Anco<sup>®</sup>
- Dura Flex<sup>®</sup> Lock
- Dome Flex<sup>™</sup> Lock
- Nylon Insert
- 360<sup>®</sup> Dome Lock
- Dome Top Lock
- Top Lock
- Hex-Loc<sup>®</sup> Reversible
- Collar Lock
- Key-Loc<sup>™</sup>
- Oval Lock
- 360<sup>®</sup> Reversible Top Lock
- Twin Spin Serrated
- Free Spinning Seal Lock
- Drake<sup>™</sup> Lock
- Marsden Type Lock
- Columbian
- Nylon Pellet

**Lok-Mor, Inc.**

Servicing the U.S.,  
 Canada, Mexico &  
 Overseas Markets

1-800-843-7230

[www.lok-mor.com](http://www.lok-mor.com)



661 Airport Drive • Mansfield, Texas • 817-477-0232 • Fax 817-453-2923



Anco<sup>®</sup>



Dome Flex<sup>™</sup>



360<sup>®</sup> Dome



Tri-Loc<sup>®</sup>



Collar Lock



Oval Lock



Twin Spin  
Serrated



Drake<sup>™</sup>



Columbian



Dura-Flex<sup>®</sup>



Nylon Insert



Dome  
Top Lock



Key-Loc<sup>™</sup>



Hex-Loc<sup>®</sup>  
Reversible



360<sup>®</sup>  
Reversible  
top lock



Free Spinning  
Seal Lock



Marsden  
Type



Nylon Pellet



## Joe Dysart

Joe Dysart is an Internet speaker and business consultant based in Thousand Oaks, California. A journalist for 20 years, his articles have appeared in more than 40 publications, including *The New York Times* and *The Financial Times* of London.

During the past decade, his work has focused exclusively on ecommerce.

Voice: (631) 256-6602; web: [www.joedysart.com](http://www.joedysart.com); email: [joe@joedysart.com](mailto:joe@joedysart.com).

# FACEBOOK'S OVERHAUL: HOW FASTENERS ARE NAVIGATING THE NEW LOOK WITH PANACHE

While Facebook's new look has left many IT security firms in a scramble, migrating to the new, mandatory change need not be accompanied by gnashing of teeth. Armed with insights from Web marketing experts, you'll be able to cruise through the upgrade – and perhaps dust a competitor or two – unphased.

In the most fundamental terms, the Great Facebook Migration of 2012 represents a move by the digital hangout to standardize the look and feel of every Business Page on its network. Essentially, Facebook wants every business on its site to be able to express what's happening with its brand right now – as well as the heritage behind that brand – all on a single page.

"The new functionality really does appear to have been introduced with brands in mind," says Pete Goold, the Managing Director of Punch Communications ([www.punchcomms.com](http://www.punchcomms.com)), a Web marketing firm.

Tom Bukacek, CEO, Black Box Social Media ([www.blackboxsocialmedia.com](http://www.blackboxsocialmedia.com)), another Web marketing firm, is less impressed. "Quite frankly, the spacing issues and the way some of the photos look on Facebook isn't really that impressive. I'm amazed that while Facebook claims to be going the direction of photos, Google+ seems to really be crushing them when it comes to pictures."

Love it or hate it, the plain fact is that all fastener

distributors with pages on Facebook will be forced to deal with its latest design change. Fortunately, getting from here to there is fairly easy, as long as you know the way.

Here are the guideposts:



Above: The opening bell at Facebook's IPO in May.

Below: A Facebook employee muses over the next step for the social networking revolution.



## Get Acquainted With Your New Start Page

Probably one of the most far-reaching impacts of Facebook's upgrade is that the design format of every business start page – or the page your visitors land on when they first visit you on Facebook – will be standardized.

Essentially, every fastener business will be required to run a large banner image, also known as a cover photo, across the top of its start page. "The large cover photo alone presents a fantastic branding opportunity," says Peter Lee, CEO, WireWalkersVA ([www.wirewalkersva.com](http://www.wirewalkersva.com)), a Web design and marketing firm.

Beneath the cover photo, you'll be asked to work with a

number of boxes, organized in a two-column format, which will showcase activity on your page. Some boxes will feature your activity – posts and announcements made by your fastener company, for example. And other boxes will feature visitor activity – their posts, any 'Likes' they've posted about your IT security firm, and similar activity.



# SUPERIOR

WASHER & GASKET CORP.

**All Product Meet ISO-9001 Requirements**

*“With The Largest, Most Comprehensive Inventory In The Industry, We Offer Just-in-time Production on all Washer Products Fabricated in All Types of Material....From Aluminum to Titanium!”*

## STANDARD WASHERS

To source specify,  
or request for quote...



[CLICK HERE](#)

## ONE AND THREE WAVE WASHERS

To source specify,  
or request for quote...



[CLICK HERE](#)

## BELLEVILLE WASHERS

To source specify,  
or request for quote...



[CLICK HERE](#)

## SPECIAL FLATS WASHERS

To source specify,  
or request for quote...



[CLICK HERE](#)

## MILITARY WASHERS

To source specify,  
or request for quote...



[CLICK HERE](#)

## ODD SHAPE WASHERS, SHIMS

To source specify,  
or request for quote...



[CLICK HERE](#)

Visit our website and click on any of the 6 Categories above. You will be able to view the full line of items by part number or size. With over 70,000 special sizes in stock, Superior will ship stock items out the same day if your order is placed before 2:00 PM EST.

With Over 100 high speed power presses, Superior now offers SPD, Superior Premium Delivery.

We now have the ability to produce those special washers with a 5 to 7 day turn around without affecting our normal scheduling.

Our in-plant machine shops will custom make a die to your specification, if it's not in our inventory of thousands of dies.



**South Carolina:**  
662 Bryant Boulevard  
Rock Hill, SC 29732  
Tel: (803) 366-3250  
Fax: (803) 366-3511

**New York:**  
170 Adams Avenue  
Hauppauge, NY 11788  
Tel: (631) 273-8282  
Fax: (631) 273-8088

[www.superiorwasher.com](http://www.superiorwasher.com) • e-mail: [swg@superiorwasher.com](mailto:swg@superiorwasher.com)



## Jim Truesdell

James Truesdell is president of Brauer Supply Company, a distributor of specialty fasteners, insulation, air filtration, and air conditioning with headquarters in St. Louis. Mr. Truesdell is adjunct professor at Saint Louis University and Webster University. An attorney and frequently published writer, he is the author of "Total Quality Management: Reports From the Front Lines".

## DISTRIBUTORS NOW FACE THE REALITY OF THE AFFORDABLE CARE ACT

For better or worse, the die is cast on the Affordable Care Act, which the Supreme Court upheld in July. When Chief Justice John Roberts supported the mandate that individuals can be compelled to purchase health insurance coverage, he did so by arguing that compulsory coverage amounts to a "tax" which Congress has the power to impose under its taxing power. This made it unnecessary for the Court to sustain the Act on the basis of an expansion of the legislature's power to regulate business under the Commerce Clause (Article I, Section 8) of the Constitution.

With the individual mandate being upheld, the rest of the Law's confusing, burdensome, and painful impact on business remains intact. Barring a complete political changeover in both the White House and the Congress, distributors are left to face up to the new situation they will encounter as the year 2014

(when most provisions will be effective) approaches.

The label that has been applied to the new law is "Job Killer." This is because many of the provisions seem to encourage businesses to keep their employee census lower than certain threshold amounts. The "big one" is a fifty employee count. Those with that many workers will be subject to the "Employer" mandate (the other side of the individual mandate). The employer will have to provide a still to be clearly defined "qualifying health insurance" to its people or face a fine of \$2000 to \$3000 per worker.

It looks like a strong incentive to not let your payroll grow to more than 50, or to convert workers to part-time so that they won't qualify in that count! With government agencies defining what constitutes a "qualifying plan", will ideological tests (i.e. abortion, same-sex marriage treatment, euthanasia) dictate what health insurance programs will allow a company to avoid the penalty tax. On the other side of things, to offset the increased cost of providing health insurance, a tax credit is available to many firms who employ 25 or fewer people. But the fine

print seems to make this credit more favorable the smaller the work force and the LOWER the average wage. So in this instance the boss will benefit if he doesn't hire more people and he keeps the wages low. Somehow I don't think this is what we need to pump up our economy and put people back to work!

Among the revenue-raising items inserted in the

healthcare law is a surtax on investment income which seems targeted at small business profits when they are paid out to people like limited partners and passive shareholders of Subchapter S Corporations. The Medicare payroll tax for wages and self-employment will also rise almost a full percent for earnings over \$250,000 (or \$200,000 for singles). Self-employed people will have to provide their own health insurance or face an excise tax of 2.5 per cent of adjusted gross income. All of these money-raising measures may be individually challenged in court over the months and years to come.



**HELP US CELEBRATE!**



Stop by our booth  
for a FREE T-SHIRT or  
go to [www.rivet.com](http://www.rivet.com)

Please visit  
us at Booth #618  
at the NIFS Show



**WE'VE BEEN KEEPING THE WORLD  
TOGETHER FOR 100 YEARS**



**Industrial  
Rivet &  
Fastener Co.**

**TIME WE RUN FOR OFFICE.**

**1-800-BUY-RIVET  
1-800-289-7483  
[www.rivet.com](http://www.rivet.com)**



**1912**  
Established in NYC as a supplier to NY Port Authority for bridges, representing Bethlehem Steel in the NYC area

**1930**  
Expanded product line to smaller diameter products



**1950**  
First documented evidence that IRFCO became known and named by its customers as the "RivetKing"

1910

1920

1930

1940

1950

1960

**1914**  
Began carrying stock to support demand

**1944**  
Developed specialty fasteners to support war efforts

**1960**  
Sales and marketing developed RivetKing into an e product



**1968**

General Rivet manufacturing opened for business and would ultimately be purchased by IRFCO in 1992. General Rivet manufactured solid and semi-tubular rivets and developed a semi-tubular product line for small electronics.



**2008**

Significant technology upgrade to conform to ISO 17025 in quality control and engineering, including purchase of salt spray, force, and micro hardness testing equipment.

**2012**

100 Year Anniversary and launch of Green Initiative

**1990**

Expanded domestic manufacturing facility, renamed it RivetKing Manufacturing

**2000**

Expanded product line to include blind rivets and blind threaded inserts. Established warehousing in Mexico

**2011**

IRF Japan and IRF Australia opened

1970

1980

1990

2000

2010

Marketing  
the  
brand  
entire  
line

**1975**

Established IRF Taiwan as manufacturing arm for production

**1998**

Moved corporate headquarters to Northvale, NJ combining manufacturing and distribution functions. Became ISO9001

**2009**

IRF Germany opened



**2005**

10 new domestic warehouses opened in Texas, California, Kansas City, Canada, Denver, Salt Lake City, and Chicago

**2010**

Developed the database logging and live retrieval of force testing, dimensional inspection and salt spray testing data

# 100 Years Later... and We're Still Revolutionizing the Industry



Your job is to help your customers make smart business decisions.

Ours is to give you the tools that help you do just that. Tools like KingSet, our most versatile and efficient handheld riveting system.

KingSet is designed specifically to adapt to a wide array of manufacturing environments and engineered to work across a variety of application ranges. But that's not even the best part.

KingSet:

- Is twice as fast as other handheld tools – and oftentimes faster
- Can be used to set most breakstem blind rivets pre-loaded on a tape
- Comes with an unprecedented three year warranty

**Now that's smart!**

Call us today to find out how you can help your customers work better and faster with KingSet.

## **Industrial Rivet & Fastener Company**

200 Paris Avenue  
Northvale, NJ 07647

**1-800-289-7483**

(1-800-BUY-RIVET)

201-750-1040

Fax: 201-750-1050

## **Find Us Online**

You can access our catalog online at:  
[www.rivet.com](http://www.rivet.com)



# ALLOY & STAINLESS FASTENERS



Alloy Steel  
Carbon Steel  
Stainless Steel  
ASTM Grades  
4140 - 4145  
B7  
Cr - Mo - V  
B16  
303  
304  
304L  
304 Cond. B  
310  
316  
316L  
316 Cond. B  
317L  
321  
347

Strain Hardened Stainless  
Duplex 2205  
Super Duplex 2507  
Zeron 100  
410  
416

## Broken down? Need-it-Now?

We Cure...



## Fastener Rage

with

**24-7 Emergency**

**"Fastener Excitement"**

440C  
501  
904L  
630  
660  
17-4 PH  
Alloy 20  
Nickel Alloys  
Superalloys  
Aluminum  
High Performance Alloys  
Titanium  
A286  
Brass  
Copper Alloys  
Bronze Alloys  
Inconel  
K-Monel  
Monel  
Ferralium 255  
Hastelloy  
Nitronic  
20Cb3  
254-SMO  
AL-6XN

**Quick Delivery is our Specialty**

[www.GoASF.com](http://www.GoASF.com)

# FASTAR

THE FIRST CHOICE IN PINS

## COILED PINS

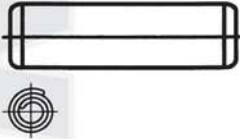

ASME B18.8.2	MS51923
ASME B18.8.3M	MS51987
ISO 8748, 8750, 8751	NAS1407
MS39086	NAS561

## SLOTTED PINS



ASME B18.8.2	MS16562
ASME B18.8.4M	ISO 8752
MS171431-171790	NAS561

## DOWEL PINS

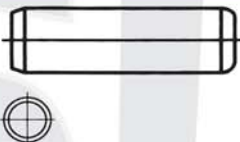

ASME B18.8.2	MS9390
MS16555	M21143/1
MS16556	M21143/2
MS9105	

## GROOVED PINS

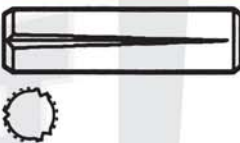

MS35671	MS35672
MS35674	MS35675
MS35677	MS35678
MS51605	MS51606

## COTTER PINS

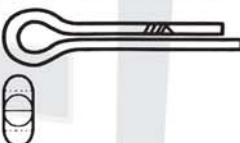

ASME B18.8.1	MS9245
MS24665	

## DISTRIBUTOR NEWS

**EFC International**, is pleased to announce the opening of their International Sales and Logistics Office to support significant international growth and to continue to expand its global footprint. EFC's success is attributable to its loyal and dedicated support of its suppliers. Coordinated effort in implementing sales and marketing plans with suppliers is a critical factor for the success in growing product lines and international business.

Bill Eagan, VP of Global Sales for EFC, states 'The creation of a formal International Sales and Logistics unit was the natural evolution for us as our international sales have significantly grown, and both our key suppliers and customers have a global presence and a need for our support'.

EFC's dynamic sales team of engineers delivers world-class assembly technology from the industry's leading manufacturers. EFC International, established in 1983, is a leading provider of specialty metal, plastic, electrical component parts to the OEM and Distribution market places.

The International Sales and Logistics office is at the St. Louis Headquarters location.

For more information contact EFC International by Tel: 314-434-2888 or visit the website at [www.efc-intl.com](http://www.efc-intl.com).

**FASTAR INC** Spook Rock Industrial Park

2 Spook Rock Rd, #E-309, PO Box 929, Tallman, NY 10982-0929

Tel: (845) 369-7990, Fax: (845) 369-7989 Sales: (888) 327-8275

email: [fastar@optonline.net](mailto:fastar@optonline.net) web: [www.fastar.com](http://www.fastar.com)





# JAY-CEE SALES & RIVET INC.

*"The Quality Rivet People"*

- **SOLID RIVETS**
- **SEMI-TUBULAR RIVETS**
- **RIVET NUTS**
- **BLIND RIVETS**



**READY FOR SAME  
DAY SHIPMENT**



- SPLIT RIVETS**
- DRIVE RIVETS**
- OLYMPIC RIVETS**
- RIVET BURRS**
- BRAKE BAND RIVETS**
- BELT RIVETS**
- SOUTHCO RIVETS**
- RIVETING TOOLS**
- AVDEL CHERRY RIVETS**
- BRAKE LINING RIVETS**
- CLEVIS PIN**
- SPECIAL FASTENERS**
- ...AND MUCH MORE!**



## CALL NOW - TOLL FREE: 1-800-521-6777

32861 Chesley Dr, Farmington, MI 48336 | Fax: 248-478-6416 | [sales@rivetsinstock.com](mailto:sales@rivetsinstock.com) | [www.rivetsinstock.com](http://www.rivetsinstock.com)

THE LARGEST SELECTION OF

# RIVETS IN STOCK

PLUS SPECIAL FASTENERS & TOOLS



### Fall River Manufacturing

540 Carrant Road, Fall River, Massachusetts 02720

Tel: 1-800-275-6991 Fax: 508-675-8770

Email: sales@fallrivermfg.com

www.fallrivermfg.com

## MANUFACTURING DOMESTIC STAINLESS STEEL & NON-FERROUS FASTENERS FOR OVER 25 YEARS

Fall River Manufacturing first opened its doors in April of 1984 in Fall River, Massachusetts where the company still operates today. For over 25 years, the company has been producing high quality cold headed stainless steel and non-ferrous screws, bolts, and nuts. Despite turbulent market conditions over the past 28 years, they have managed to become one of the leading domestic manufacturers serving fastener distributors throughout the US for both commercial and Mil-Spec fasteners.

The company continues to grow with over 50 employees and operates under a newly constructed 143,000 square foot manufacturing complex. Fall River is 9001:2008 ISO Certified, and QSLM Class 2 approved, complete with in-process inspections, material and production lot number traceability. They have the ability to supply full certifications to 100% domestic manufacture when required by the purchaser for municipal and government projects.

Company Vice President and General Manager, David Monti, stated that one of the company's key strategies is service. In a market where there have been few technological advances over the years, there are many manufacturers both foreign and domestic who can make quality fasteners. With the growing demand for faster deliveries and in response to "line down" situations, Fall River Manufacturing offers some of the quickest turn-around times in the industry.

Fall River provides personal service and technical assistance to the distributor market that is second to

none. When distributors utilize the type of manufacturing expertise that Fall River provides, they have a new level of confidence that enables them to succeed in competitive markets. Fall River also partners with distributors by initiating blanket order programs with scheduled release dates. This is a great way to stabilize prices over the duration of the blanket order, enabling the distributor to better manage their inventory as well as cash flow.



Fall River specializes in cold-formed American and Metric fasteners ranging in sizes from #8 (M4) through 5/8" (M16) diameter, and lengths up to 6" (150MM). They cover a wide range of Head Styles, Threads, Point Styles and many grades of stainless steel such as 18-8, 302HQ, 304, 304L, 309, 316, 316L, 410, 430, 431, NiCu400, A286, Aluminum, Silicon Bronze, Brass and Copper. Specifications include ISO, IFI, ANSI, SAE, DIN, JIS, MS, MIL, ASTM, FQA, DFARS, ROHS and 100% Domestic.

Fall River is approved for the Qualified Suppliers List for Manufacturing (QSLM) (cage code 1JWL5). They manufacture a full line of domestic stainless steel and non-ferrous Standards, Specials and MIL-SPEC fasteners.

Fall River has recently expanded their product line to include domestically made stainless steel hex nuts in 304 and 316 stainless steel.

You can count on Fall River Manufacturing to provide the distributor market with top quality fasteners, backed with the value-added service you would expect from a leading domestic manufacturing company. Call today and experience all that Fall River Manufacturing has to offer. ◉



YOUR DOMESTIC SOURCE  
FOR MS PARTS



WWW.FALLRIVERMFG.COM

QSLM CLASS 2 APPROVED  
CAGE CODE: 1JWL5  
ISO 9001:2008



## MANUFACTURING STANDARDS, SPECIALS AND MIL-SPEC FASTENERS

STAINLESS STEEL AND NON-FERROUS SCREWS BOLTS AND NUTS

PHONE 800-275-6991

FAX 508-675-8770



## Richard Hagan

Richard P. Hagan is the president of Pinnacle Capital Corporation, a boutique investment banking firm which specializes in providing merger & acquisition advisory services to the global fastener industry. Hagan has more than twenty-three years of international investment banking experience and has worked on successful domestic and cross-border M&A transactions, corporate restructurings and capital raisings. Hagan earned a B.A. in Economics from the University of North Carolina at Chapel Hill and an M.B.A. in Finance from Fordham University in New York City. Contact: Phone: 212-267-8200 or Email: rphagan@pinnaclecapitalcorp.com.

## FASTENER COMPANY ACQUISITIONS COMPLETED DURING THE FIRST HALF OF 2012

In this article, we will briefly review all the fastener company acquisitions - a total of 15 worldwide - completed during the first 6 months of 2012. Of course, it is impossible to track every single fastener company transaction because many deals involving private companies are not publicly disclosed. That said, we believe the following list is the most comprehensive (and detailed) you will find.



On January 25, 2012, Novaria Group Inc. purchased Fitz Manufacturing Industries, Ltd. ("Fitz"). Fitz, a privately-owned company, was founded in 1995 and is located in North Richland Hills, Texas (outside Fort Worth). The company manufactures a diverse range of nuts, bushings and precision-machined components for the aerospace marketplace (for both military and commercial applications). Fitz operates from a single 132,000 square foot facility and employs approximately 150 people. Following the transaction closing, the company was renamed Fitz Aerospace Inc. Novaria Group is a private investment firm that acquires and develops aerospace component manufacturing companies. Based in Fort Worth, Texas, Novaria Group is the newly-formed aerospace and aviation investment platform of Satori Capital LLC.

**Purchase price: not available**



On January 30, 2012, B/E Aerospace Inc. (Nasdaq: BEAV) purchased UFC Aerospace Corp. UFC Aerospace, a privately-owned company, was founded in 1972 and is

headquartered in Holtsville, New York. UFC Aerospace is a global distributor of fasteners and related assembly hardware to the aerospace market. The company also provides value-added Inventory Supply Chain Management Services, including kitting and JIT delivery programs. UFC Aerospace has approximately 250 employees in 17 locations across the United States and in 6 countries around the world. B/E Aerospace is the world's largest distributor of aerospace fasteners and consumable hardware and the world's leading designer and manufacturer of aircraft cabin interior products (for both commercial aircraft and business jets).

**Purchase price: \$400 million**



On February 17, 2012, MW Industries Inc. purchased Pontotoc Spring, a division of Union Spring & Manufacturing Corporation. Pontotoc Spring, located in Pontotoc, Mississippi, is a manufacturer of aftermarket coil springs used in automobile and light truck suspension systems. The company also manufactures metal stampings for a diverse range of industrial, consumer and automotive applications. MW Industries is a manufacturer of engineered mechanical components, including highly-engineered springs, specialty fasteners, machined components, precision stampings and custom wire forms. The company is headquartered in Logansport, Indiana and is comprised of 14 operating divisions located in 10 states across the United States. MW Industries is a portfolio company of Genstar Capital LLC, a San Francisco-based private equity firm.

**Purchase price: not available**

# Make it **Real**

# **EZ** *Real People. Real Service. Real Quality.*



When you call **EZ Sockets**, you get a real person. And that's just the beginning of your rewarding purchasing experience. From our personal customer service to our high quality, lot traceable products; from our low prices to our signature packaging, we make your life **EZer**.

And nowadays, we could all use a little EZ.



#### Standard & Special Sizes

- Socket Head Caps, Socket Sets (All Points), Nylon & Brass Tip Set Screws, Flat Head Socket Caps, Button Head Socket Caps & Socket Shoulder Screws in Alloy & Stainless, Inch & Metric
- Short & Long Arm Hex Keys, Low Head Socket Caps & Standard Dowel Pins in Inch & Metric
- Full Thread & Left Hand Thread Socket Caps, 3/4" Taper & 7/8" Taper Pipe Plugs, Pull Dowel Pins, Square Head Sets Screws, Hex Key Sets & T-Handles & Sets in Inch Sizes

## **EZ Sockets, Inc.**

**Dallas, TX**  
(800) 456-2228  
Fax (214) 630-1274

**Portland, OR**  
(800) 456-2228  
Fax (214) 630-1274

**HEADQUARTERS/WAREHOUSE**  
5 Cornell Parkway, Springfield, NJ 07081  
(973) 376-5605  
(800) 631-7833  
Fax (973) 376-7130  
e-mail: ezsockets@juno.com  
www.ezsockets.com

**Elk Grove Village, IL**  
(800) 631-7833  
Fax (973) 376-7130

**Commerce, CA**  
(800) 456-2228  
Fax (214) 630-1274



### Hillsdale Terminal

2222 Moore Rd, P.O. Box 100, Jonesville, MI 49250  
 Tel: 1-800-495-3150 Fax: 517-849-9516  
 Email: info@hillsdaleterminal.com  
 www.hillsdaleterminal.com

## THE TOTAL AMERICAN DREAM

Hillsdale Terminal is a US manufacturer of solderless terminals since 1976. The family run business was started by Harry "Frank" Condon. His two sons, Jim and John and daughter, Lori, currently run the business. Several moves occurred over the 30 years, and in 1987 the current site was purchased between the towns of Jonesville and Hillsdale, Michigan. Hillsdale has added onto its facilities five times since 1987, bringing the current building to 35,000 sq feet. The original catalog started with stamping only 21 different styles of terminals. Today over 125 different styles are stamping, ranging in sized from 22-18 to 2 ga. Our employees play a BIG part of the business. Most have worked for Hillsdale for many years. We have 3 generations currently working for us.



Left to Right: Jim Condon (President), John Condon (VP), Kurtis Condon, Bennett Adams, Sarah Deck & Lori Atkins (Office Manager). Center: Harry "Frank" Condon (Chairman of the Board)

**STAMPING** Strip copper and brass is purchased direct from the mill. Certifications and Specification are met to the highest level. The material is run through one of the 15 high speed presses. The average production is 10 - 14 million terminals per month, on a one shift basis.

**PARTS WASHER** Parts are ran through a parts wash to remove all lubricants and debris, improving the plating finish, before sending to the annealing oven.

**ANNEALING** Terminals are heated in an oven which removes the hardness or the temper of the copper. The process of annealing softens the copper making it

possible for a good crimp.

**BRAZING** Some of the terminals are sent to a brazing machines. Parts are fed through feeder lines until a thin line of silver solder seals the barrel of the terminal. This sealing enables the terminal to be crimped in any position without opening. Other parts are sold with the seams butted and are not sent through this process.

**PLATING** This is about the only process Hillsdale has done out side the premises. Parts to and from the platers are done on a weekly basis. The electro-tin plating is placed on the terminal for corrosion resistance. The plating meets Mill Spec MIL-T-1072C Type 1, ASTM B 545B. specifications. The steel terminals are nickel plated making them high temperature up to 900°F.

**MOLDING** A molding department houses 9 injection molding machines. The recent addition of an extruder has allowed Hillsdale to manufacture 99% of it's insulation in house, helping control quality and cut cost with huge freight savings. This department also molds the red, white and blue instant tap connectors. Hillsdale may be the only manufacture to make these in the USA.

**ASSEMBLY MACHINES** 55 fully automated machines assemble the bare terminal with vinyl, nylon, a nylon with support sleeve or a heat shrink insulator. Hand assembly machines do the low volume parts and a rivet machine rivets the three and ways parts together.

**PACKAGING** Parts are packaged on one of our auto baggers or hand weighted on scales. The standard package of 1,000 is labeled and placed in stock. Packaging can also vary from the 100 count bag or plastic box. 

Bare • Nylon • 3 PC Nylon  
 Crimping Tools • Cable Ties  
 Wire • Heat Shrink Terminal  
 Wire Nuts • Terminal Kits

**Hillsdale Terminal**

Wire Range: 22-18, 16-14,  
 12-10, 8, 6, 4, 2, 1/0, 2/0,  
 3/0, 4/0

Call for Free Catalog & Pricing!  
**1-800-447-3150**  
 Fax 517-849-9516  
 www.hillsdaleterminal.com  
 PO Box 100 Jonesville, MI 49250

# IDEAL FASTENERS INC.



ISO 9001: 2008 and AS9100 REV. C Certified

Licensed Manufacturer of  
Torx® Drive • Torx Plus® • Torq Set®

Manufacturer of Socket Head Cap Screws



#### Administration Building

3850 East Miraloma Avenue  
Anaheim, CA 92806 USA

#### Production Building

3860 East Miraloma Avenue  
Anaheim, CA 92806 USA

#### Give Us A Call Today!

toll free: 800.821.8540  
tel: 714.630.7840  
fax: 714.632.3829

**We sell only  
what we  
Manufacture!**



**Representative for New York & New Jersey:**

Smith Associates Inc. tel: 973.810.2900 • fax: 973.810.2901 • email: smithfast@aol.com

[www.idealfasteners.com](http://www.idealfasteners.com)



### Precision Technology Supplies

The Birches Industrial Estate, East Grinstead, RH19 1XZ, UK  
 Tel: +44 1342 410758 Fax: +44 1342 311464  
 Email: sales@pts-uk.com  
 www.pts-uk.com

## PTS: YOUR SOURCE FOR METRIC STAINLESS

Precision Technology Supplies Ltd (PTS) was formed in 1988 in a small office in East Grinstead, England to supply Metric Stainless Steel fasteners to the UK market. By 1992, they had grown to a size where they were exporting to large European distributors. The company received quality accreditation to ISO 9001 in 1996 and this has been regularly updated. In 1997, PTS moved to a larger facility.

Since 2000, PTS has exhibited their products at many trade shows in the UK, Europe, Asia and North America, gaining enhanced market and product knowledge and making a lot of friends along the way. They also became a member of BAFD (British Association of Fastener Distributors) in 2006.

In 2008, PTS purchased an additional warehouse for their growing business and have since built a third facility.

PTS completed its website in 2011 to provide stock pricing, availability and an automatic global freight calculator. Customers can also view photos and technical specifications on all 30,000+ items. Other

features include real-time parcel tracking and order status. Customers in over 50 countries now use their website to order and quote for Metric Stainless Steel fasteners.

Due to demand from Asia, 2012 saw PTS launch their first E-Catalog which is updated in real-time as new product lines are continually added. This October they are exhibiting at NIFS in Las Vegas for the 5th time and look forward to meeting both friends and customers at Booth #348.

PTS has over 25,000 different Metric products to DIN and ISO

standards in Stainless Steel A2 and A4 grades. Their "off-the-shelf" range is a very accommodating M1.0 to M36, including the widest range of non-standard lengths and diameters. They are globally known as specialists for their product and market knowledge with the four company directors alone having over 110 years experience in the fastener trade between them.

If you need to source Metric Stainless Steel fasteners, off-the-shelf at great trade prices, don't gamble, talk to the specialists at PTS. 







**PRECISION TECHNOLOGY SUPPLIES**

Stainless Steel Industrial Fastenings & Precision Turned Parts

# THE METRIC NUTS

Booth 348 | National Industrial Fastener Expo



## EUROPE'S FAVORITE SUPPLIER OF STAINLESS STEEL METRIC FASTENERS

Visit us at Booth 348 at the National Industrial Fastener Expo

- Off-the-shelf stock range M1.0 to M36 diameter
- Over 25,000 Stainless Steel Metric product lines
- A2 and A4 material grades
- Largest stock range of non-standard lengths and diameters

A complete range of stainless steel metric fasteners...

- |                           |                             |
|---------------------------|-----------------------------|
| metric Nuts               | metric Studs                |
| metric Washers            | metric Self Tapping Screws  |
| metric Socket Screws      | metric Self Drilling Screws |
| metric Hexagons           | metric Woodscrews           |
| metric Machine Screws     | metric Chipboard Screws     |
| metric Security Screws    | metric Retaining Rings      |
| metric Slotted Grubscrews | metric Screws for Plastics  |
| metric Pins               | metric Drive Bits           |

EXPRESS SHIPPING, DOOR-TO-DOOR FROM THE UK IN 2 DAYS...

[WWW.PTS-UK.COM](http://WWW.PTS-UK.COM)

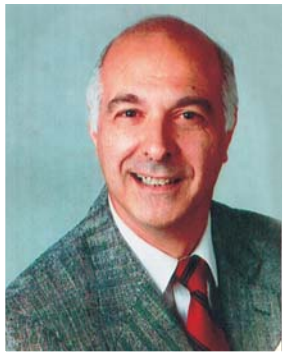

## Bart Basi

*Dr. Bart A. Basi is an expert on closely-held enterprises. He is an attorney, a Certified Public Accountant, and President of The Center for Financial, Legal & Tax Planning, Inc. He is a member of the American Bar Association's Tax Committee on Closely-Held Businesses.*

# CORPORATE RECORDS? I THINK THEY ARE AT MY ATTORNEY'S OFFICE...

## Introduction

Unfortunately, corporate records are routinely neglected by those in charge. The subject rarely comes up, and record books are largely perceived as unnecessary, tedious records that take up precious time to format and get right. The fact is many corporations fail to hold even annual meetings. Additionally, many corporations' record books are blank and many directors, officers, and shareholders (many times one and the same) are not even aware of the requirements and potential liabilities

Corporate record books contain the formal minutes of a corporation's stockholders' and directors' regular and special meetings held during each year. The books should contain the articles of incorporation, corporate by-laws, stock certificates, resolutions and minutes of corporate meetings.

Specific requirements exist in each state regarding form, content, viewing rights, and penalties for not complying with the law. Illinois holds the following:

## A. Requirements

Required to be kept under Illinois Business Corporation Act of 1983, each corporation shall keep correct and complete books and records of account and shall also keep minutes of the proceedings of its shareholders and board of directors and committees thereof; and shall keep at its registered office or principal place of business in this State, or at the office of a transfer agent or registrar in this State, a record of its shareholders, giving the names and addresses of all

shareholders and the number and class of the shares held by each. A record of shareholders certified by an officer or transfer agent shall be competent evidence in all courts of this State.

## B. Shareholders are entitled to view the corporate records

Any person who is a shareholder of record shall have the right to examine, in person or by agent, at any reasonable time or times, the corporation's books and records of account, minutes, voting trust agreements filed with the corporation and record of shareholders, and to make extracts therefrom, but only for a proper purpose. In order to exercise this right, a shareholder must make written demand upon the corporation, stating with particularity the records sought to be examined and the purpose therefore.

## C. If the records are not available for viewing, penalties can follow.

If the corporation refuses examination, the shareholder may file suit in the circuit court of the county in which either the registered agent or principal office of the corporation is located to compel by mandamus or otherwise such examination as may be proper. If a shareholder seeks to examine books or records of account the burden of proof is upon the shareholder to establish a proper purpose. If the purpose is to examine minutes or the record of shareholders or a voting trust agreement, the burden of proof is upon the corporation to establish that the shareholder does not have a proper purpose.



TO DELIVER  
IN RIGHT CONDITION



SINCE 1988

www.zonbix.com.tw

Zonbix Enterprise Co., Ltd.

No.66, Lane 18, Jong-Hwua St., Hu-Nei, Kaohsiung, 82943, Taiwan

Tel: 886-7-6994364 Fax: 886-7-6994318 raymond@zonbix.com.tw bsales@zonbix.com.tw



Your reliable option for  
**FORMED SPRING STEEL  
FASTENERS**



Supplying Distributors Nationwide Since 1989

- DIRECT COMPETITOR MATCHES
- DISCONTINUED ITEMS!
- FACTORY DIRECT PRICES
- MANY IN-STOCK ITEMS
- SHORT LEAD TIMES
- ON TIME OR B4 DELIVERY

*e-quality-fast* →<sup>®</sup> brand

Your *e*-conomical Source  
for *qual*-ity Fasteners  
and *fast* → Delivery



U-CLIPS



U-NUTS



J-NUTS



SPECIALS



TWIN NUTS



FLAT NUTS

405 Production Drive • South Elgin, Illinois 60177

Toll Free: 888-NUTS-R-US (888-688-7787)

Fax: 847-695-6336

On Line: [www.e-quality-fast.com](http://www.e-quality-fast.com)

E-mail: [sales@e-quality-fast.com](mailto:sales@e-quality-fast.com)



## "The Good Guys"

Our commitment to you  
*"No supplier will work more  
 diligently for you, our customer and  
 partner in business."*



*The Managing Partners  
 Jason Bertone & Mark Georgia*



### A SUPPLIER YOU CAN TRUST

*The World's  
 Most  
 Comprehensive  
 Inventory  
 of Fine Quality  
 Electronic  
 Hardware*

550 Spring Street Naugatuck, CT 06770  
 Tel (203) 720-1146 • Fax (203) 720-1156

7814 Kingspointe Pkwy Orlando, FL 32819  
 Tel (407) 226-2112 • Fax (407) 226-3370

**VISIT US AT [WWW.FASCOMP.COM](http://WWW.FASCOMP.COM)**

## DISTRIBUTOR NEWS

**Elgin Fastener Group** has announced the recent appointment of Marty Goeree to the position of Vice President of Sales.



Goeree brings more than 16 years of experience as a fastener industry executive to EFG, having spent that time in key management positions and multiple locations with Fabory North America, Fabory CEE, and Textron Fastening Systems. He holds bachelor's degrees in geography, history, and education from Mount Allison University in Sackville, New Brunswick, Canada, and earned his MBA from Oxford Brookes University in Oxford, England.

Elgin Fastener Group CEO, Jeff Liter, said, "We are very pleased and excited to welcome Marty Goeree to the Elgin Fastener Group. His knowledge of the domestic and international fastener distribution networks will aid our sales efforts immediately; his addition represents a vital step for our organization as we continue our efforts to be recognized as the premier North American supplier of specialty fasteners." Former EFG Vice President of Sales, Joe Hertz, will continue to serve EFG as Director of Sales, reporting to Goeree while concentrating on sales management and maintenance of key accounts.

Elgin Fastener Group is comprised of seven leading domestic specialty fastener manufacturers (Ohio Rod Products, Leland Powell Fasteners, Chandler Products, Quality Bolt & Screw, Silo Fasteners, Landreth Fastener, Northern Wire, LLC), a metal finishing company (Best Metal Finishing), and an offshore sourcing and engineering division (Elgin Fasteners International).

Contact Elgin Fastener Group via phone at 812-689-8917, email: [quotes@elginfasteners.com](mailto:quotes@elginfasteners.com), or visit their website at [www.elginfasteners.com](http://www.elginfasteners.com). Also find Elgin Fastener Group on Facebook and Twitter.

# BUY FROM BEACON!

{Make your mother proud for once}

She looked out for you in ways you didn't even realize. We do the same, except we won't use it against you for the rest of your life.

## THREAD CUTTING SCREWS

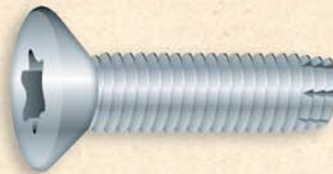

Type F | Type 23 | Type 25 | Type 1

## THREAD FORMING SCREWS

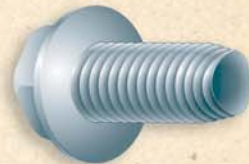

Full Trilobe | Full Trilobe 48-2 (for plastic applications)

## SEMS SCREWS



Steel-Zinc (RoHS) | 18-8 Stainless Steel

## HIGH LOW TAPPING SCREWS

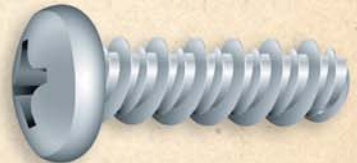

Steel-Zinc (RoHS) | 410 Stainless | 18-8 Stainless

## SHEET METAL/TAPPING SCREWS



Type "A" | Type "AB" | Type "B"

## MACHINE SCREWS



Steel-Zinc (RoHS) | 18-8 Stainless Steel



[www.beaconfasteners.com](http://www.beaconfasteners.com)

**Call us, we worry! 800-669-2658**

### OUR KEY COMPONENT IS QUALITY.

Each lot is performance tested in house per ASME specifications in addition to complete in-house dimensional testing.

**Beacon**  
FASTENERS AND COMPONENTS, INC.

*We treat you like family. Maybe too much like family.*



**Industrial  
Rivet &  
Fastener Co.**

**Industrial Rivet & Fastener Co.**  
200 Paris Avenue Northvale, NJ 07647  
Tel: 1-800-289-7483 Fax: 201-750-1050  
Email: info@rivet.com  
www.rivet.com



## DISTRIBUTORS & RIVET MANUFACTURERS: WORKING TOGETHER TO SOLVE PROBLEMS FOR OEMS WITH BLIND RIVETS

by Steven Sherman, Vice President of Engineering

Original equipment manufacturers (OEMs) are always looking for more efficient assembly methods that offer low startup costs, and many times the answer is a blind rivet. This is due in large part to innovations in the riveting process that have made using blind rivets in a variety of applications faster and more cost effective than ever before.

Previously, riveting was a two-person process with one person driving the rivet and the other supporting it during setting. Permanent fastening evolved from here into a single person process, but requiring the use of an expensive and specialized riveting machine. Today, further advancements have made it possible for one person to accomplish the same tasks with common pneumatic hand tools. As a result, there is no longer a need for a highly skilled workforce – making the cost for OEMs to establish a new production line dramatically less expensive than it once was. With these more efficient riveting systems, OEMs are able to bring their newly developed products to market faster. This also provides for greater flexibility, enabling them to scale production for seasonality or launch new products quickly and easily. As an added benefit, the combination of flexibility and low startup costs is helping to bring manufacturing back to the United States and paving the way for American competitiveness.

Technology, however, is not the only thing that has changed the way OEMs work. The current environment is much more collaborative than it has been in the past, and distributors are working closely with their customers as well as their manufacturers to find innovative solutions that add efficiency to assembly methods while also continuing to bring costs down.

### Overcoming Typical Constraints as Partners

While blind riveting has existed for nearly 50 years, rivet manufacturing methods still make it

challenging to customize a rivet for a specific application. Customers are forced instead to use boilerplate “catalog” rivet designs that may not work reliably.

Plus, when a rivet manufacturer is unable to access specific application requirements – either due to the fact that they are not local or because they lack the depth of knowledge needed to properly assess the application – blind rivets are often not even recommended as a fastening solution.

As an example, a manufacturer of smart boards came to the conclusion that a blind rivet would be an ideal method to fasten the sides on aluminum extrusions. However, various distributors and manufacturers said there was no product available in their respective catalogs that would properly set the rivet in this particular application. This was due to two main reasons:

- 1) The hole could not be accessed by the rivet
- 2) The hole could not be accessed by the nose piece of the riveting tool.

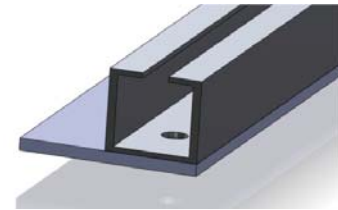

Figure 1 - Original Application Example

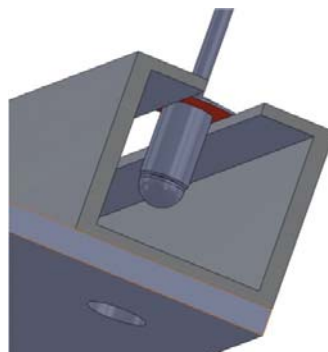

Figure 2 - Problem: Rivet Access Interference



Figure 3 - Problem: Nose Piece/Riveting Tool Interference

# Spacers & Standoffs

- We Manufacture HEX and ROUNDS 3/16 to 5/8 diameter
- STANDOFFS in Brass, Aluminum Steel & Stainless Steel

**NOW AVAILABLE!**  
Call us for our Product Catalog



**W.J. ROBERTS COMPANY INC**

181 Central Street, PO Box 1146T, Saugus, MA 01906

Tel: 781.223.8176 Fax: 781.231.1456

[www.wjroberts.com](http://www.wjroberts.com)



*SMALLEY, the Spirolox Retaining Ring and Wave Spring design and manufacturing SPECIALISTS!*

## THE #1 DISTRIBUTOR SOURCE FOR: Spirolox® Retaining Rings

50 YEARS of expertise, exclusively manufacturing Spirolox Retaining Rings and Smalley Wave Springs



Smalley manufacturing, design, and customer service facilities are 100% dedicated to continuing our reputation as the # 1 global source for Spirolox spiral retaining rings and wave spring products

### STAINLESS STEEL FROM STOCK

- Available from stock in 302 and 316 stainless steel
- 5,000 stock retaining rings; 1/4" to 16" diameters
- No-Tooling Costs™ on specials; .200" to 90" diameters
- Constant Section Rings now available from stock; .375" to 10"

### COMPATIBLE WITH STAMPED RETAINING RING GROOVES

- Easy to assemble and remove
- No Ears To Interfere with mating components
- Immediate design support by engineers experienced in Spirolox ring applications

### Distributors' Source

- Free Samples Immediately
- Timely Delivery Guaranteed
- Free Design Assistance to "Support Your Customers"



[www.smalley.com/getcatalog](http://www.smalley.com/getcatalog) • [info@smalley.com](mailto:info@smalley.com)  
Lake Zurich, IL • 847.719.5900 • Fax: 847.719.5999

# ACFComponents & Fasteners, Inc.

## MASTER STOCKING DISTRIBUTOR:

AVK	BIVAR	HEYCO
PANDUIT	RICHCO	RAF
3M	SUMITOMO ELECTRIC	



**New Products: Heyco-TITE** — family of straight-through liquid-tight cordgrips for flexible wire cables and cords in electrical enclosures of any kind, including NPT, metric and PG threads in straight-thru, pigtail and right angle configurations.

[www.acfcom.com](http://www.acfcom.com)



**NOW OPEN IN GUADALAJARA, MEXICO**

**Northern California Service Center**  
31012 Huntwood Avenue  
Hayward CA 94544  
United States of America  
TEL: 800.487.2100  
FAX: 510.471.7018

**Southern California Service Center**  
742 Arrow Grand Circle  
Covina, CA 91722  
United States of America  
TEL: 800.824.8576  
FAX: 626.915.7065

**Mexico Service Center**  
Camino a la Tijera No.806 - C6  
Col. La Tijera  
Tlajomulco de Zúñiga, Jal.  
TEL: 011-52-33-3687-1951  
FAX: 011-52-33-3687-1955

SEFA - PO Box 448, Elba, AL 36323 • Tel: 847.370.9022 • Fax: 847.516.6728 • Email: [sefa@theseffa.com](mailto:sefa@theseffa.com) • [www.theseffa.com](http://www.theseffa.com)

## SOUTHEASTERN FASTENER ASSOCIATION

# SEFA ANNOUNCES UPCOMING SPRING CONFERENCES

### Upcoming Spring Conferences

SEFA is pleased to announce plans for the next two years' conferences to allow you ample time to plan your calendars. The 2013 SEFA Spring Conference/Table Top Show will be held over the dates of April 16, 17, & 18 at the Evergreen Marriott Conference Resort in Stone Mountain, GA. This venue offers great amenities for our event as well as several park activities for those wanting to spend some extra time enjoying the area, yet is only 16 miles from downtown Atlanta. Registration forms will soon be available allowing exhibitors to reserve their tables.

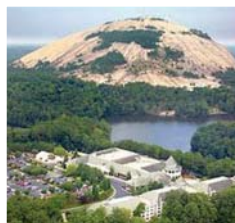

Embassy Suites, CharlotteConcord. The rotating of locations allows us to offer our membership the opportunity to network with the fastener industry in various locations. We look forward to bringing you enhanced programs. Watch [www.theseffa.com](http://www.theseffa.com) for updates regularly.

### New Membership

SEFA is pleased to announce the following new members:

CSM Fastener Products in Elk Grove Village, IL  
Fastener Specialties Manufacturing in West Palm Beach, FL  
Martin Fastening in Jackson, TN  
Nylok LLC in Macomb, MI  
Star Stainless Screw Co. in Norcross, GA  
Trio Fasteners, Inc. in Ashland, VA

For more information about the association or to join the SEFA just visit website [www.theseffa.com](http://www.theseffa.com) and complete the on line membership application. 

In 2014, we will hold our Spring Conference in Charlotte, NC. over the dates of April 9, 10, & 11 at the



SINCE 1970



MADE IN USA

# **KEN FORGING**

***SERVICE  
IS OUR STRENGTH***



***QUALITY  
IS OUR COMMITMENT***

**www.KENFORGING.com**

Phone: 440.993.8091 • Toll Free: 888.536.3674 • Fax: 440.992.0360

## OUT PACE THE COMPETITION!

THE ONLY BUSINESS SOFTWARE  
YOU'LL EVER NEED FOR YOUR FASTENER  
WHOLESALE/DISTRIBUTION BUSINESS.

STOP BY AND SEE US  
AT NIFS BOOTH 117.

AUTOMATION EXPERIENCE TECHNOLOGY CONNECTIVITY FLEXIBILITY SUPPORT

Distribution One's V2 Fastener is a powerful ERP solution for Fastener Wholesalers and Distributors. V2 Fastener software offers an exciting, dynamic and fully functional Windows® system. Our fastener distribution software can automate all facets of your business operations. It's powerful enough to handle all of your order entry, sales, accounting, finance, purchasing, secondary processing, inventory, and CRM needs. Our fastener distribution software was designed to run your entire business operation from order processing through general ledger.

Providing powerful business software  
for Wholesalers and Distributors.

[www.distone.com](http://www.distone.com)

Mount Laurel, NJ | Irving, TX  
p. 856-380-0629 | [info@distone.com](mailto:info@distone.com)

*DISTRIBUTION*  
**One**

## DISTRIBUTOR NEWS

In its recent Board of Directors meeting David Wooldridge was unanimously appointed to serve as the President and Chief Executive Officer of **Batching Systems, Inc.**

Wooldridge, 45 has served as acting President since the death of his father in February 2012, former President and founder, Donald Wooldridge. Wooldridge has spent the last 15 years of his career at Batching Systems, Inc. as an integral part of the management team working alongside the President and other key management associates in preparation for his future role in managing the business. He has extensive knowledge in numerous plant functions and has a thorough understanding of the company's core business and customer base.

Batching Systems, Inc. (BSI) is a recognized leader in volumetric weighing, counting, batching and filling technology. Founded in 1989, the Company remains privately owned and continues to provide high technology filling and packaging solutions to the industrial, food, and medical industries. BSI systems are highly engineered and rugged offering reliability and precision filling accuracy while at the same time providing maximum operational flexibility.

For more information on BSI and the solutions we provide in high-speed counting applications, call 410-414-8111, e-mail [sales@batchingsystems.com](mailto:sales@batchingsystems.com) or visit our website today at [www.batchingsystems.com](http://www.batchingsystems.com).

ROUND, OVAL & RECTANGULAR - INTERNAL THREADS



OFFSET - INTERNAL THREADS



OVAL & RECTANGULAR, 180° INFINITE POSITION - INTERNAL THREADS



NON-FOLDING, SHOULDER/NO SHOULDER - EXTERNAL THREADS



90° 2-POSITION, 180° 3-POSITION, ROUND & OVAL - EXTERNAL THREADS



ROUND 90° & 180° FREE FALL & INFINITE POSITION - EXTERNAL THREADS



# Handles

What you need at the right price:

- Largest variety
- 41 different finishes
- Quickest delivery
- Hundreds of custom variations
- Make-to-print capabilities
- World class quality
- Made in the USA

Give us the opportunity to beat the competition – you won't be disappointed.



RAF Electronic Hardware  
95 Silvermine Rd., Seymour CT 06483  
Tel: 203 888-2133 Fax: 203 888-9860  
Email: [info@rafhdwe.com](mailto:info@rafhdwe.com)  
[www.rafhdwe.com](http://www.rafhdwe.com)



RAF ELECTRONIC  
HARDWARE

a Division of MW Industries, Inc.



**USA Fastener Group, Inc.**

1300 Gazin Street, Houston, Texas 77020

Tel: 1-866-546-5872 Fax: 713-641-4655

Email: sales@usafgrp.com

www.usafgrp.com

## AN INTRODUCTION TO USA FASTENER GROUP, INC.

Established in 2002, USA Fastener Group, Inc. has established itself as a recognized leader in the Fastener Industry. With well over 100 plus years of combined sales experience, stable financial backing, and the commitment towards continued growth, USAFG remains dedicated to providing the highest quality customer service and support to existing and future customers.

Located in Houston Texas, with nearly 100,000 square feet of manufacturing and warehousing space, USAFG has positioned itself to provide customers with quality products in a timely and efficient manner.

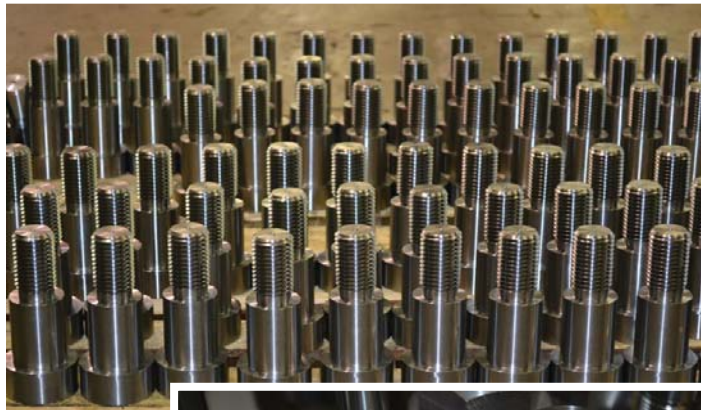

**Manufacturing capabilities include but are not limited to:**

- CNC machining
- CNC Milling
- Engine Lathe Machining
- Milling
- Drilling
- Tapping  
(Tapping oversize for Coatings and Galvanizing)
- Sawing  
(up to 14" in diameter with bundling capabilities)
- Threading  
(Cut Thread and Roll Thread Capabilities)
- HOT Forging (Hex Bolts/Nuts/12Pts./ Flange Bolts/ Sockets to name a few)

Being located in a large industrialized city does have its advantages. In addition to the extensive line of

manufacturing capabilities, USAFG also offers to its customers a wide variety of coatings and platings. Some of these include PTFE coating (Xylan<sup>®</sup>, Fluorokote1<sup>®</sup>, SC1<sup>®</sup>, and Sermagard<sup>®</sup>), zinc plating, cad plating, hot-dipped and mechanical galvanizing, Dacromet<sup>®</sup> and others.

One of the many benefits USAFG offers to all of its

customers is an emergency callout program. A benefit of this program is that a representative with the company can be reached 24/7 in any given moment. This service also provides customers with the assurance that USAFG is always there when needed. No matter how large or small the emergency may be, USAFG's dedicated employees are eager to assist.

While they are constantly analyzing

and adapting to today's economy, USAFG remains focused on the task at hand; supporting current and future growth. In taking the next step forward, USAFG has created new jobs within the company. Additional office support (clerical and accounting), inside sales support, outside sales, engineering and quality assurance support, warehousing (shipping/receiving), manufacturing, and manufacturer's representation are all some of the many value added changes that we have made within the company.

*please turn to page 148*

VISIT OUR BOOTH #339  
NATIONAL FASTENER SHOW  
OCTOBER 2012



## MACHINE SERVICES

- CNC MILL & LATHE
- CHAMFERING
- CUTTING
- DRILLING
- MILLING
- TAPPING
- THREADING
- HOT FORGING

## SPECIALS & STANDARDS



- HEX & HVY HEX BOLTS
- HVY HEX BOLTS -B7
- FLANGE BOLTS & 12 PT
- T-HD BOLTS
- SOCKETS
- ANCHORS
- NUTS AND MORE!

## CARBON STEEL

1018, 1020 & A36

## ALLOY STEEL

SAE GR.8, 4140, 4340,  
A193 B7, A193 B7M,  
A193 B16, A320 L7,  
A354 BC, A354 BD

## COPPER ALLOYS

COPPER, BRASS,  
SILICON BRONZE,  
PHOSPHOR BRONZE,  
ALUMINUM BRONZE

## STUDS



- FULL THREAD
- DOUBLE END
- TAPPED END
- SINGLE END
- TAPERED
- COLLAR STUDS
- ACME THREADS

**\*ASSEMBLY AVAILABLE\***

## STAINLESS STEEL

18-8, 302, 303, 304,  
310, 316, 316L, 321,  
410, 410HT, 17-4 PH,  
A286, ALLOY 20, B8 &  
B8M

## NICKEL ALLOYS

MONEL, K-MONEL,  
NICKEL 200,  
INCOLOY,  
HASTELLOY

## COATINGS

XYLAN, ZINC PLATING,  
MECHANICAL GALVANIZING,  
EPOXY, FLUOROKOTE #1,  
CADMIUM PLATING,  
HOT DIPPED GALVANIZING,  
MOLY, TEFLON,  
YELLOW CHROMATE  
BLACK OXIDE,  
PHOSPHATE,  
SERMAGARD'S

## NON-METALIC

NYLON, TEFLON,  
FIBER, NEOPRENE,  
RUBBER

## EXOTICS

TITANIUM,  
ZIRCONIUM

1300 GAZIN STREET  
HOUSTON TEXAS, 77020

**MAIN: (24/7): (713) 641-4600**

**TOLL FREE: (866) 546-5872 FAX: (713) 641-4655**

**CONTACT US AT: SALES@USAFGRP.COM**

INCH & METRIC  
DOMESTIC & IMPORT

# Detroit Washers & Specials

## Detroit Washers & Specials

32235 Industrial Road, Livonia, MI 48150

Toll Free: 1-877-694-0412 or Sales 1-734-261-2600, x339

Email: dan@detroitwasher.com

www.detroitwasher.com

## DETROIT WASHERS - YOUR PREMIER SOURCE

Detroit Washers & Specials is your premier, trusted source for high-quality, American-made industrial washers, shims, spacers, and specialty stampings. Our products serve a wide variety of applications, including automotive, appliance, military and aerospace. We are ISO/TS 16949:2009 certified for stamping and welding. DWS can provide your company with PPAP's, ISIR's and most any quality paperwork you might need. Certifications and PPAP's are available upon request.

At Detroit Washers & Specials we have the latest, most accurate equipment to ensure maximum flexibility, and consistent quality, including: High-speed specialized presses for washers and shims, 22 presses from 3-300 tons, uncoilers and feed equipment to a maximum of 20,000lbs, 3 roll form machines up to .060 stock, and welders and turntables.

We can manufacture outside diameters to 8", with thickness up to .250". Our material capabilities include

silver, bronze, phos bronze, Copper - beryllium copper, aluminum, 3003, 5052, 6061 and others. Non-metallics include Acetal, nylon, nylatron, delrin, Teflon, Mylar polyethylene, polyurethane, PVC, zytel, fibre, mica, phenolic, neoprene, rubber, and others.



Tell us your specific design and material requirements, and we will work with you to build the parts that you require.

Our special finishing/secondary services include: Deburring – tumbling, MIG, TIG and spot welding, heat treating to spec, plating to spec, grinding, special parts coloring, and Inkjet lettering and numbering.

From simple stampings like washers and shims made in compound tooling, to larger brackets and special stampings

made in progressive dies, Detroit Washers and Specials is your trusted source. Our goal is to pride our customers with friendly, courteous service, fair pricing and excellent quality. Our Customer Service team is ready to take care of any challenges that come their way. 

# Detroit Washers & Specials

Check out  
our website!



Livonia, Michigan - USA

[www.detroitwasher.com](http://www.detroitwasher.com)

**(877) 694-0412**

TS 16949-2009

US Gov't Cage Code 5VLM4

**Military, Industrial, Automotive, Heavy Truck**

ALL PARTS MADE IN USA

*Come visit our booth*

**#1713** at the

**National Industrial  
Fastener & Mill Supply  
EXPO**

**October 11th & 12th**

SANDS CONVENTION CENTER  
Las Vegas



**Fully Threaded Studs**  
**Double End Studs**  
**Single End Studs**  
**Bent Bolts**  
**Pins**  
**Rail Bolts**  
**Hanger Bolts**  
**Dowel Screws**

**Diameters: 4-40 to 1/2", M4 to M12**

**Lengths: continuous thread to 6"**  
**single-end & double-end to 40"**  
**straightened & cut wire to 120"**

**Materials: carbon steel, stainless**  
**aluminum, brass**



**HANGER BOLT & STUD CO.**

Ph: 800-537-7925 Fx: 800-994-2658

E-mail: [sales@hangerbolt.com](mailto:sales@hangerbolt.com)

[hangerbolt.com](http://hangerbolt.com)

# Memo to Purchasing

REGARDING: **SPECIALS** and **NON-STANDARDS**

Eastwood Manufacturing can supply any type of fastener in any type of material normally in three weeks or less.

**SPECIFICATIONS:** All ASTM, SAE, ISO METRIC, most Military and Federal including Mil-S-1222

**CAPABILITIES:** #5 through 3" diameter  
Bolts, Nuts, Studs, Screws, Sockets, Pins and Washers

**MATERIALS:** All materials are available

We have made parts from the following within the last year:

## Stainless Steel

302

303

304

304L

309

310

316

316L

317

317L

321

330

347

410

416

420

422

430

431

440

501

17-4 PH

Alloy 20

Nitronic 60

AL6XN

904L

254 SMO

2205

304 SH

316 SH

## Nickel Alloys

Nickel 200

Inconel

Incoloy

Monel 400

Monel 405

Monel 500

Hastelloy

Waspaloy

MP35N

Alloy Steels (various grades) • Carbon Steel • PVC, Teflon  
Aluminum • Titanium • Zirconium • Tantalum

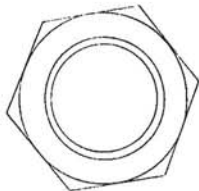

**EASTWOOD MANUFACTURING**  
6825 Breen Street • Houston, TX 77086  
(281) 447-0081 • FAX (281) 447-0098

*Fastener Specialists*





# KEY BELLEVILLES, INC.

**We are the largest Disc Spring Manufacturer!**

- *Complete size range from .236" to 36" O.D. & 3" Thick*
- *Largest Raw Material and Finished Inventory in the World*
- *We manufacture Metric Parts to DIN Specs*
- *Complete Line of Stainless and Inconel Parts*
- *10,000 Different Sizes in Stock*

**Call toll free from anywhere in the U.S. and Canada at:**

**Phone: 1-800-245-3600 • Fax: 1-800-847-1672**

**Key Bellevilles, Inc.**

100 Key Lane • Leechburg, PA 15656-9531 U.S.A.

Phone: 724-295-5111 • Fax: 724-295-2570

www.keybellevilles.com • e-mail: sales@keybellevilles.com

*Visit Our Website  
or Call for a FREE  
Engineering CD*

# RIVETS

**HUGE INVENTORY**

**Aerospace & Commercial  
From 1/16" to 1-1/2" Diameter!**



- |                           |                         |                                     |                                |
|---------------------------|-------------------------|-------------------------------------|--------------------------------|
| • Tubular Rivets          | • Split Rivets          | • Rivet Caps                        | • Back-Up Washers              |
| • Blind Rivets            | • Belt Rivets           | • Rivet-Nuts                        | • AN, MS, NAS, LS, BACR        |
| • Solid Rivets            | • Binder Rivets         | • Speed Fastening®                  | • Custom Rivets & Fasteners    |
| • Drive Rivets            | • Tinner's Rivets       | • Blind & Press-In Threaded Inserts | • Riveting Tools & Accessories |
| • POP®, Avdel® & Southco® | • Brake & Clutch Rivets | • Self-Clinching Captive® Fasteners | • Riveting Machines & Tooling  |



**HANSON RIVET  
& SUPPLY CO.**  
13241 Weidner Street  
Pacoima, CA 91331

**SINCE  
1929**

[www.hansonrivet.com](http://www.hansonrivet.com)

Please ask for Distributor Sales  
**1-800-RRRIVET**  
(800-777-4838)  
FAX: 818-485-0540

# ABBOTT

## The ONLY Supplier You Need

### HARD-TO-FIND LOCKNUTS

manufactured in our factory – deliveries starting in 4 weeks.

### MANUFACTURED

in our factory or imported from our overseas partners; whatever works for you to get you the order, all with the same Abbott quality and service.

### PRICING

to help you get the business & achieve the largest gross profit.

### ENGINEERING

& design assistance to help you make more Locknut Sales.

### MATERIAL

products produced in all materials.

### QUALITY

products since 1948.



### APPROVALS

QPL, MS-AN-NAS and QSLD/QSLM standards and major corporate approvals.

Now  
Manufacturing (USA)  
Grade 5 & 8 to  
MIL-DTL 45913

**Call Distributor Sales TODAY!**  
**847.777.3030**



QUALITY & INTEGRITY

**ABBOTT-INTERFAST CORP.**

190 Abbott Drive Wheeling Illinois 60090 ■ Tel 847.459.6200  
Fax 847.459.4076 ■ Website: [www.abbott-interfast.com](http://www.abbott-interfast.com)

## DISTRIBUTOR NEWS

**Lindapter USA** national sales manager Charlie Humphreys announced two new distributors: Clement Support Services and Struct-Fast Inc. serving the California and Western U.S. market.

Lindapter North American distributors already included All Pro Fasteners, Texas; Southwest Fastener, Arizona; UCC Steelwork Connections with New Jersey, Delaware and Florida locations; Strut & Supply, Illinois; Edge Construction Supply, Washington; and UCC Industries International Inc, Canada.

Clement Support is located at 480 Vandell Way, Campbell, CA 95008. Tel: 408-227-1171 Fax 408-227-1178 or visit online at [www.clementsupport.com](http://www.clementsupport.com).

Struct-Fast is headquartered at 8648 Commerce Dr. #1200, Easton, MD 21601. Tel: 410-770-9414 or 1-800-327-6719, Fax 410-770-9416, email: [hugh@structfast.com](mailto:hugh@structfast.com) web: [www.structfast.com](http://www.structfast.com).

UK-based Lindapter was founded in 1934 by engineer Henry Lindsay to market the Lindsay Bolt Adapter, a single casting which converted a bolt into a hook bolt. The adaptor clasped an iron beam flange with the nut to connect equipment to steel.

Contact Lindapter by Tel: (44)-1274-521444 Fax (44)-1274-521130, by email: [inquiries@lindapterusa.com](mailto:inquiries@lindapterusa.com) or on the internet at [www.lindapter.com](http://www.lindapter.com).

**ORDER ONLINE BY THE:  
BOX, MASTER PACK, KEG, OR PALLET**

**PLACE YOUR ORDERS  
ONLINE  
NOW!!**

[www.titanfasteners.com](http://www.titanfasteners.com)

**DOMESTIC AND  
IMPORTED FASTENERS  
ARRIVING WEEKLY!!**



Titan makes buying **PACKAGED FASTENERS** easy. You'll be impressed with our Inside Sales Staff. We take orders **YOUR WAY**. Plus, we NOW offer ONLINE ORDERING and added services that include:

- Custom Packaging
- 45,000 SKU Product Line
- Low \$25.00 Min. Order
- Freight Terms
- Technical Support
- Volume Pack Discounts
- Custom Kits & Poly Bagging
- Full Line Product Catalog
- Full Lot Traceability
- Quality Packaging
- Direct Import Mills
- Barcode Scanning for Shipping Accuracy

Brunswick, Georgia  
2627 Sidney Lanier Drive  
Brunswick, GA 31525  
(800) 789-8112

Elk Grove Village, IL  
2501 Lively Blvd.  
Elk Grove Village, IL 60007

Cranbury, NJ  
114 Melrich Road, Ste. F  
Cranbury, NJ 08512  
(800) 950-2852



**Rotor Clip Company Inc.**

187 Davidson Avenue, Somerset, NJ 08873  
 Tel: 1-800-557-6867 Fax: 732-469-7898  
 Email: info@www.rotorclip.com  
 www.rotorclip.com

## RETAINING RINGS SECURE COMPONENTS IN ROLLER SCREW ACTUATOR *by Vincent E. Rodgers*

There are two retaining rings utilized in this planetary roller screw and each do the same job. The purpose of the rings is to secure the threaded rollers, timing gears, and spacer as they rotate in unison with the screw shaft. Without these rings in place the threaded rollers would simply push the gear and spacer out of place causing the entire roller screw to malfunction. The rings are beveled, featuring a 15 degree beveled angle along the outer edge which fits into a precut, complementary groove to firmly secure the actuator components in place as the screw moves up and down the shaft.

The retaining rings use less material making the roller screw lighter and cheaper on the already expensive planetary roller screw. Although the planetary screw does not have to be maintained frequently, it can easily be taken apart by removing the cover and then removing the rings from one end or both to gain access to the threaded rollers for maintenance.

An actuator is a type of motor for moving or controlling a mechanism or system. There are different types of actuators that perform different tasks from small to large. Some examples include power locks on a car, an electronic gate, or a valve system in oil pipelines. Most actuators are controlled electronically but there are others that are controlled manually, such as a car jack. The main purpose of actuators is to facilitate movement and to carry or support loads.

The actuator featured here is called a roller screw, more specifically a planetary roller screw because the threaded rollers rotate on axis like a planet in space. The actuator travels on the threaded screw shaft moving extremely heavy loads. Unlike other screw technologies, the roller screw does not have to be maintained frequently. Common uses for this type of actuator are the landing gear for airplanes because they do not take a lot of room; they are lightweight and can withstand extreme pressure and weight. 

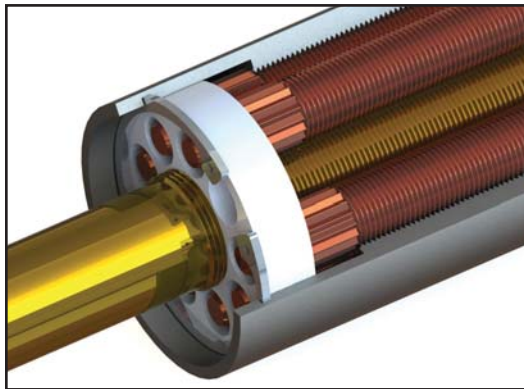

*ABOVE: The main purpose of actuators is to facilitate movement and to carry or support loads. BELOW: Retaining rings secure the threaded rollers, timing gears, and spacer as they rotate in unison with the screw shaft on this actuator.*

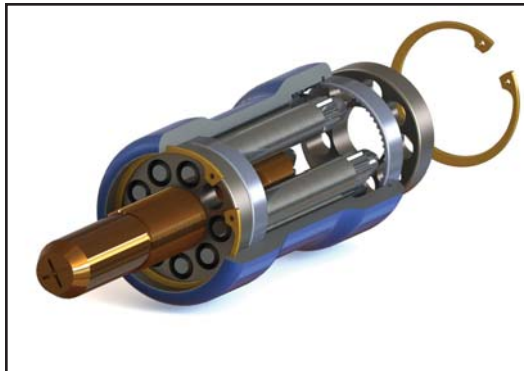

# The Dale Company

U-BOLTS - SQUARE U-BOLTS - ANCHOR BOLTS - STUDS - J-BOLTS - EYE-BOLTS - S-HOOKS

- **PRO-COAT U-BOLT™:**  
Pipe protection and corrosion resistance.  
Eliminate metal to metal contact.
- Standard & Long Tangent U-bolts in stock
- 1/4" - 36" pipe
- Plain finish, Hot Dipped Galv,  
Zinc, 304 SST, 316 SST, Teflon  
and **PRO-COAT U-BOLT™** (shown)



**24 HOUR SERVICE**

Specials are made to order with short lead times

**713-928-3437**

[sales@dalecompany.com](mailto:sales@dalecompany.com)

[www.DaleCompany.com](http://www.DaleCompany.com)



6216 NAVIGATION, HOUSTON, TX. 77011 713.928.3437 F. 713.928.8065



**Your One-Stop for  
Factory-Direct Fasteners**

**High Quality, Great Service**

**On Time Delivery**

**Competitive Prices**

**Importing has Risks,  
Let us Do it for You!**

**TEL: 503-244-1516 FAX: 503-452-9855**

**WEB: [www.offshoremilling.com](http://www.offshoremilling.com)**

## CAPITAL MARKETING



### Sales and Marketing From a Premier Agency

Covering North Carolina, South Carolina, and Virginia

**Call Robbie Gilchrist  
(336) 884-1704**

**[info@capital-marketing.com](mailto:info@capital-marketing.com) • Fax (336) 884-1778**



Capital Marketing is headed by Robbie Gilchrist, a 30-year veteran of the fastener business and a lifetime member of NFDA—the National Fastener Distributors Association.

Call Robbie today to discuss persuasive, energetic representation for your company.

**Capital Marketing™**  
[www.capital-marketing.com](http://www.capital-marketing.com)

## DISTRIBUTOR NEWS

**Pivot Point Incorporated**, announces the release of their latest full line catalog. This 48 page full color catalog features both stock and specialty fastener solutions, plus technical information for products, materials, plating and heat treatments. A special section details the Leitzke family's 83 year history in the fastener industry.

New products are debuted, including Extended Locking Pull Pins and Precision Machined Components. Expanded product sections provide exhaustive information on popular Pivot Point fastener inventions including SLIC Pins™, Bow-Tie Locking Cotter Pins™, Rue-Ring™ Locking Cotter Pins, Nylon Lanyards™, Infinity S-Hooks™ and more.

Contact Pivot Point to request a copy or visit the new [www.pivotpins.com](http://www.pivotpins.com) to request a catalog online.

\* \* \*

**The Gilchrist Foundation** has awarded four scholarships from the 2012 applicants. Congratulations to the recipients. We wish them well and are pleased to assist them with their education. They are as follows;

Brittany Moulton sponsored by Edsco Fasteners of Elba, AL. Jack Nelson Sponsored by FPC Corporation of Waconda, IL. Kyle Strahm sponsored by Wurth Snider Bolt of Louisville, KY. Daniel Lyman sponsored by Hodell-Natco, Valley View, OH.

Robbie and Gina Gilchrist established the Gilchrist Foundation Fastener Scholarship in 2000. Their goal was to return something to an industry that was very good and supportive to them. The criteria for applying are that upon completion of their schooling the applicant must make an effort to work in the Fastener Industry or be a current employee from an NFDA or SEFA member company. Unlike other scholarships, the Gilchrist Foundation Scholarship may be applied for during any year of a persons schooling. Also, an applicant may be a part time student currently working in the fastener industry.

The Gilchrist Foundation Scholarship is available to any student of an NFDA or SEFA member company.

For additional information contact: Robbie Gilchrist at 336-884-1704 or send an email to: [rgilchr485@aol.com](mailto:rgilchr485@aol.com).

# Chicago Hardware & Fixture Co.

"Manufacturing Only in America for 100 Years...and Counting!"

**American Made**      **Family Owned**      **Superior Quality**

chicagohardware.com

## VIRGINIA FASTENERS

THE GALVANIZED SOURCE



TIMBER BOLTS  
HEX BOLTS  
ANCHOR BOLTS  
SQUARE HEAD BOLTS  
LAG BOLTS

CARRIAGE BOLTS  
TIE RODS  
HEX NUTS  
SQUARE NUTS  
FLAT WASHERS

OGEE WASHERS  
DOCK WASHERS  
SQUARE WASHERS  
ALL THREAD ROD

**Huge Inventory of Hot Dipped Galvanized Hardware  
Take Advantage of Our Attractive Freight Allowances**

**1-800-368-3430**

P.O. Box 3108 Chesapeake, VA 23327 [www.vafasteners.com](http://www.vafasteners.com)

**Phone 757-436-1717 Fax 757-436-1460**

**E-mail [sales@vafasteners.com](mailto:sales@vafasteners.com)**

SFA - 292 Sugarberry Ci., Houston, TX 77024 • Tel: 713.952.5472 • Fax: 713.952.7488 • Email: swfa@swbell.net • www.sfa-fastener.org

## SOUTHWESTERN FASTENER ASSOCIATION

# SFA AWARDS TWELVE SCHOLARSHIPS; TWO FALL DINNER MEETINGS SCHEDULED

The Southwestern Fastener Association awarded twelve scholarships in July to a group of well deserving students. The winner of the Will Rodriguez scholarship was Mallory Condon, representing Hillsdale Terminal. Mallory is entering her sophomore year at Northwood University. Bill Unferth, retired and a long time fastener industry executive, elected to give back to the industry that helped his family with their college educations by making a generous contribution to the SFA scholarship program this year. SFA awarded a scholarship in the name of the Unferth Family to Jared Burks, representing Tifco, Inc. Jared is enrolled in a pre-med program at Arkansas State University.

Additional scholarship winners were Andrea Carr, Porteous Fastener Co, attending Texas State University; Tyler Condon, Hillsdale Terminal, attending Trine University; Abbey Jackson, Delta Fastener, Inc., attending Texas A&M University; Louis Marelllo, Metric &



Multistandard Components, attending College of the Holy Cross; Paden Mouton, Drillco, Inc., attending Southeastern Louisiana University; Melissa Murphy, Threaded Fasteners, Inc., attending Troy University; Frank Palatucci, Ford Fasteners, attending Ramapo College of New Jersey; Emily Pels, Tifco, Inc. attending the University of California – Davis; Connor Silverstein, EFC Inc., attending the University of Missouri and Megan Woodard, Drillco, Inc., attending Tulane University.

SFA has scheduled two dinner meetings for the Fall. The first dinner meeting is scheduled for October 25 in Houston and the second dinner meeting will be November 1 in the D/FW area. Specific locations and program content will be announced at a later date.

In additional SFA activity, the Association has selected the dates of April 25 through April 27, 2013 for their Spring Conference at Lowes Ventana Canyon, Tucson, Arizona. Lowes Ventana Canyon is a four star resort with two championship golf courses. It promises to be a rewarding experience for SFA members. 

## SFA SCHOLARSHIP AWARDS - JULY 2012

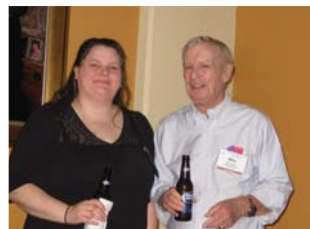



# Celebrating Our 10th Anniversary!

[www.bigredfasteners.com](http://www.bigredfasteners.com)

**Manufacturer of  
Domestic made and  
melted in the USA  
All Thread Studs.**

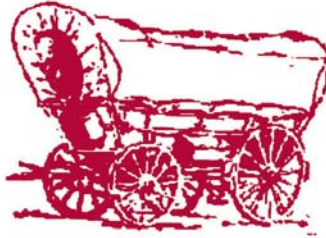

- ASTM A193 B7
- ASTM A193 B7M
- ASTM A193 B16
- ASTM A320 L7
- ASTM A320 B8
- ASTM A320 B8M

## BIG RED FASTENERS

608 N. Walnut Avenue • Broken Arrow, OK 74012  
918-251-7291 • Fax: 918-251-7311 • Toll Free 1-866-621-6565

**BOLTS • CAP SCREWS • MACHINE SCREWS • LAMALLOY PRODUCTS • LOCKNUTS • SOCKET PRODUCTS • NUTS • CONSTRUCTION • WASHERS  
METRIC • WOOD SCREWS • DECKING SCREWS • TAPPING SCREWS • SELF-DRILLING SCREWS • BRASS • STAINLESS • WIRE ROPE & CHAIN • STUDS • ANCHOR PRODUCTS  
PINS • THREADED PRODUCTS • BENT & FORMED BOLTS • RIVETS • THREAD CUTTING SCREWS • THREAD ROLLING SCREWS • CHANNEL STRUT  
MISCELLANEOUS • STEEL TANK INDUSTRY PRODUCTS**

### DISTRIBUTORS NOW FACE THE REALITY OF THE AFFORDABLE CARE ACT *continued from page 32*

So what kind of strategies are we likely to see small businesses employ as they face the uncertainty of the Affordable Care Act? It could bring a surge in the hiring of part-time employees to keep companies from tripping the 50 and 25 employee limits. Is it possible we could even see down-sizing of full timers to fall below the thresholds? How many companies will elect to pay the penalties and not provide coverage to their full-time workers? What will be the impact on overall jobs growth in our still-struggling economy?

This was the wrong time, and the wrong format, to experiment with solutions to the health care crisis. When our economy is reeling, companies are failing, and people are out of work it is not the time to commit massive resources from both government and the private sector to engage in social engineering. But then, did not some of the President's operatives offer the advice that they did not want to squander the opportunity provided by a "good crisis?" While so much is being decided and everything is up in the air it seemed a perfect time for those seeking

to push us further down the path to socialism to seize the moment.

Of course, all business like certainty. With the Court's ruling distributors can now at least turn their attention towards "how" to comply. The federal government is compelled by law to avoid rules and regulations that unfairly burden business. Hopefully, the people writing the administrative regulations will remember this and strive keep paperwork and costs down.

There is still time to put some reasonable limitations on this law or to correct some of its aspects that create incentives for behavior that is not in our national economic self-interest. All of this will play out as individual businesses make decisions as to how they will comply. Of course, we are still in the midst of an important political campaign where the Health Care law is a central point of debate. Perhaps it is not a complete fait accompli yet. Let's see what the voters say in both the White House and the Congressional elections! 

Become a  
Distributor for  
**Thread Repair**

**CHRISLYNN**  
Threaded Inserts  
**PRECISION**

Sell to:

- \*Oil fields \*Mining
- \*Aircraft \*Automotive
- \*Electronics \* Marine

**5 U.S. SHIPPING LOCATIONS**



**Professional Thread Repair**

**CHRISLYNN THREADED INSERTS**

WWW.CHRISLYNNINSERTS.COM

**\*\*NO MINIMUMS\*\***

**\*\*\*SAME DAY SHIPPING\*\*\***

\*MEETS MIL-SPECS \*DFAR COMPLIANT  
GIANT METRIC up to M64 & GIANT 8-PITCH up to 5" DIA  
EXTRA FAST DELIVERIES ON SPECIALS

EMAIL : [sales@chrislynninserts.com](mailto:sales@chrislynninserts.com)

PHONE: 800-926-1495

FAX: 888-526-4566

**LOBSTER DRAWING  
AT EVERY SHOW!!**



**CHRISLYNN**

THREADED INSERTS

PRECISION

Tel: 1-800-926-1495 Fax: 1-888-526-4566

Email: [info@chrislynninserts.com](mailto:info@chrislynninserts.com)

[www.chrislynninserts.com](http://www.chrislynninserts.com)

**"GIANT?"**

**WHY THE GIANT CARTOON  
FIGURE YOU ASK??**

It is an eye catching way to bring attention to two important facts to distributors.

1) There is a giant \$ market for threaded inserts used in original equipment and thread repair requirements.

2) Giant size American and metric inserts and kits are part of our standard Chrislynn stock, ranging from:

- 2-56 to 5 inches in American sizes
- M2 to M64 in metric sizes.

What our competitors regard as special, we typically have in our warehouse, ready to be shipped on the same day the order is received.

All fastener and industrial distributors that deal with threads would consider threaded inserts to be part of that same product family.

If you call on industries that include:

- Automotive • Aircraft
- Electronics • Mining
- Marine • Petroleum
- Power generation

You will find that they have used inserts for many years. That means this is not a new product which will have to be introduced to your customers.

To get started selling threaded inserts, contact us and we will explain the simple requirements to start selling inserts, possibly that same day. 

# DURHAM MFG®

Est. 1922

**The Durham Manufacturing Company**  
 201 Main Street, Durham, CT 06422  
 Tel: 1-800-243-3774 Fax: 1-800-782-5499  
 Email: info@durhammfg.com  
 www.durhammfg.com

## DURHAM MANUFACTURING COMPANY CELEBRATES ITS 90<sup>TH</sup> ANNIVERSARY

Durham Manufacturing is celebrating 90 years of | plant founded in 1922 remains in Durham, CT and a continued growth in the manufacturing of quality products. Founded in 1922, Durham Mfg. has grown to become one of the largest manufacturers in the US of specialized fastener storage/ merchandising bins, racks, boxes and cabinets; material handling and industrial storage cabinets, carts, trucks, and specialty items; first aid and safety cabinets and office storage products.

Durham has two manufacturing facilities; the original

90<sup>th</sup>  
 anniversary

a second facility in Juarez, Mexico. Durham also operates distribution centers in Durham, CT, El Paso, TX, Atlanta, GA and Chicago, IL. To help celebrate Durham's 90th year anniversary, a new logo has been designed.

Durham is committed to quality and continued growth with

current and future distributors. We look forward to our next milestone in 2022. 

### Your Single Source for Industrial Storage, Material Handling & Safety Equipment

**DURHAM MFG®**  
 Est. 1922

Visit us at  
 Booth # 615

Compartment Boxes  
 & Racks



Heavy Duty Bearing  
 Slides and full panel Cradle.  
 Hold 75 lbs. per cradle.



FM Approved  
 Flammable Storage



Vertical Bar Rack

New slope design standard  
 on all 12" deep Bins



Drawer Cabinets

Nut & Bolt  
 Bins

Base



Heavy Duty Storage Cabinets



Spill Control



Mobile Wire Spool Rack

201 Main Street - PO Box 230 - Durham, CT 06422  
 Phone: 800.243.3774 - Fax: 800.782.5499  
 info@durhammfg.com - www.durhammfg.com

**The Durham Manufacturing Company**



Industrial Fasteners Institute  
636 Oak Tree Blvd. • Independence Ohio 44131  
Phone: 216.241.1482 • Fax: 216.241.5901  
www.indfast.org



## THE BIGGEST ROI A FASTENER COMPANY CAN GET SADLY GOES UNDER EXPLOITED

by Joe Greenslade Director of Engineering Technology, IFI

One of the major weaknesses in the fastener industry today is the same one I found on July 15, 1970, my first day in the fastener industry. The breadth and depth of technical knowledge is woefully lacking.

Training provides the best possible return on investment for fastener companies!

When I started as an inside sales person in Arlington, Texas for CAMCAR, a fastener company with 1,000 employees and seven divisions, the only training available was on the job training (OJT). I sat next to a nice gentleman who was a very loyal CAMCAR employee. He taught me all about dealing with paperwork and how to do pricing. I soon learned he knew absolutely nothing about fastener technology and had no interest in learning. All of his training had been OJT. After a very short time I wanted to know why we stocked thousands of different types of fasteners. They all had a lump on one end and a wrinkle on the other, but I just knew there had to be reasons why we had so many different styles and types.

I started my quest for knowledge by taking one piece out of every different part box we had in stock and I wanted to know why a user would use a pan head instead of round head or a truss head for starters. I went up the chain to the manager who ran the facility. He was also a very nice man who had 25 years of sales

experience with CAMCAR. His answer to my questions was to hand me a copy of the 4th Edition of the IFI Standards Book dated 1965. In those days it was only 401 pages (1,137 pages in the 8th Edition) and just as boring reading then as it is today.

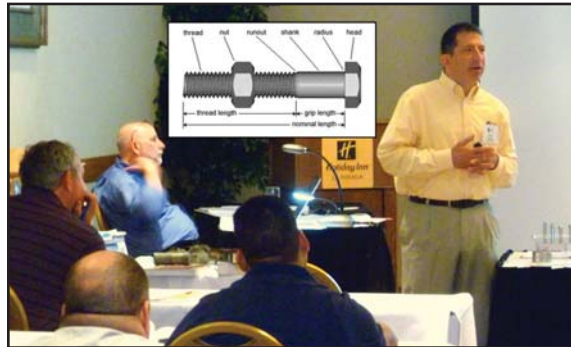

I struggled through the IFI book as best I could, because I just knew there must be a reason why we had thousands of different types of screws, and my manager told me all of the answers were in there. As I came to various points in the book that were not clear to me I would take the book into the

manager and ask him for specific answers to my various questions.

I soon learned that he did not know much about fastener technology either and was not very interested in it. He said, "Joe, you have asked me more technical questions in the past six months than I have encountered in 25 years." So much for the effectiveness of OJT where fastener technology is concerned.

That did not stop me. I kept digging and, as I met people in the home office in Rockford, Illinois, I scrapped together a growing stock of information. After about nine months some of the executives in Rockford starting wondering who this young pain in the rear in Texas was and whether he was worth investing any time and effort into.

*please turn to page 231*





# STELFAST<sup>®</sup> INC.

ISO 9001:2008 • MBE Certified



Nuts



Locknuts



Screws



Bolts



Washers



Threaded Rods & Studs



Anchors



Metric Products & Specials



Wheel Parts

Call Stelfast!



**Your Quality Source for Imported Fasteners**

## Locations

**Cleveland**  
800-729-9779

**Atlanta**  
877-472-0033

**Chicago**  
866-783-0161

**Dallas**  
866-783-5378

**Houston**  
800-473-1168

**Los Angeles**  
800-581-8346

**New Jersey**  
800-506-6380

**Toronto**  
800-268-4723

**Montreal**  
800-361-2155

[www.stelfast.com](http://www.stelfast.com) • [sales@stelfast.com](mailto:sales@stelfast.com)



*Service You Deserve,  
People You Trust!*





ISO 9001:2008 CERTIFIED

## PREMIUM STRUT ACCESSORIES

Spring Nuts  
Beam Clamps  
Rigid Clamps  
EMT Clamps  
Multi-Grip Clamps  
Tubing Clamps  
Copper Tubing Clamps

Cushion Clamps  
Flat Fittings  
Angle Fittings  
Wing Fittings  
Post Bases  
Splice Channel  
General Fittings

### CONTINUOUSLY ADDING NEW PRODUCTS



The above is a brief list of available products. Most fittings are available in a variety of finishes including zinc plated steel, hot dip galvanized, powder coating and stainless steel. Our prices are extremely competitive and the quality is exceptional. With same day shipping for in stock items our customer service is second to none. Please ask your Divspec Sales Representative for product samples.

Visit us in Las Vegas at the National Industrial  
Fastener & Mill Supply Expo  
October 11-12, 2012. Booth 350  
See our catalog online @ [www.divspec.com](http://www.divspec.com)

### OUR COMMITMENT TO QUALITY IS "STAINLESS".

605 Springfield Rd.  
Kenilworth, NJ 07033  
PH: (908) 688-2550  
FX: (908) 688-9385  
[njsales@divspec.com](mailto:njsales@divspec.com)

4785 Kirk Rd.  
Winston-Salem, NC 27103  
PH: (336) 760-0050  
FX: (336) 760-0580  
[ncsales@divspec.com](mailto:ncsales@divspec.com)

## DISTRIBUTOR NEWS

Edwards & West Inc., t/a **Divspec** has been serving the Industrial, Commercial, Manufacturing, Institutional and Construction trades since 1980. Their success can be directly attributed to their commitment to quality products, outstanding service, and a sincere obligation to insure the complete satisfaction of their valued customers. In recent years they have forged an affiliation with Flexistrut Australia and one of their divisions, Flexistrut (Changshu) Company Limited, who is an ISO 9001-2008 Certified manufacturer located in mainland China. The association with Flexistrut has allowed Divspec to broaden their horizons and seek distributors who are selling or considering selling to the trades who use strut and associated fittings. Divspec's on-line catalog can be found at [www.divspec.com](http://www.divspec.com). The fittings displayed in the catalog are a sampling of the products they have available. A variety of finishes including Zinc Plated Steel, Zinc Dichromate, Zinc Trivalent, 304 Stainless Steel, 316 Stainless Steel, Hot Dip Galvanized & Powder Coat are available.

With direct container shipments, private labeling, bar-coding & direct to customer blind shipping, Divspec can offer solutions to improve inventory management and increase profitably.

Contact Divspec at: New Jersey 1-800-752-3194 North Carolina 1-866-434-8773 or online at [www.divspec.com](http://www.divspec.com).



### ALFA Manufacturing Industries Inc

7845 N. Merrimac Ave, Morton Grove, IL 60053  
Tel: 847-470-9595 Fax: 847-470-9696  
Email: sales@alfatools.com  
www.alfatools.com



**National Abrasives  
and Tools, Inc.**

## ALFA TOOLS EXPANDS PRODUCTION

Alfa Tools, has recently expanded its National Abrasives and Tools facility in Morton Grove, IL, to include the production of Type "R" Non-Woven Surface Conditioning Discs. This state-of-the-art production utilizes spin-welding technology that insures a permanent bond between the abrasive material and the Type "R" Quick Change fitting. These high performance abrasive discs feature a tight, non-woven fibre web impregnated with a specially processed Aluminum Oxide grain for fast initial cut, high productivity and long disc life. Applications include deburring, blending, cleaning and finishing of metal surfaces as well as oxidation and gasket removal. These discs are available in Extra Fine, Fine, Medium, Coarse and Extra Coarse grades in 1-1/2", 2", 3" and 4" diameters.

The National Abrasives facility, established in 2005, also produces the highest quality Aluminum Oxide, Silicon Carbide and Ceramic grain abrasive discs in Pressure Sensitive Adhesive and Hook & Loop formats with paper and

cloth backings. National Abrasives complete abrasive program includes over 4,000 stock coated abrasive products including Discs, Abrasive Sheets, Rolls, Bands and Belts as well as made-to-order specials.

National Abrasives products are an integral portion of Alfa Tools' complete offering of Cutting Tools, Power Tool Accessories, Abrasives and Chemical Products. These products are sold exclusively through Alfa Tools' network of distributors, who offer their customers this complete "One-Stop Shop" program.

Alfa Tools recently celebrated its 35th year in business. The new, full-line Alfa Tools General Catalog is due out in January of 2013 and will reflect the growth of the product line to nearly 30,000 SKUs. Look for expanded offerings of Blitz Bits® Premium Heavy Duty Drill Bits, MegaCut® Abrasive Wheels and Circular Saw Blades, Carbide-Tipped Hole Cutters and Solid Carbide End Mills with TiCN and TiAlN coatings. 



# ALFA TOOLS

## YOUR SOURCE FOR INDUSTRIAL CUTTING TOOLS, POWER TOOL ACCESSORIES & ABRASIVES

- Large Inventory On Hand
- Premium Industrial Quality
- Multiple Warehouses
- 98.5% Same Day Order Fill Rate
- Low Minimum Order
- Private Label Programs

VISIT US AT  
THE NATIONAL INDUSTRIAL FASTENER &  
MILL SUPPLY EXPO • LAS VEGAS, NV  
OCTOBER 11-12, 2012  
BOOTH 422



Contact us today for complete details

7845 N. Merrimac Ave.  
Morton Grove, IL 60053

Phone: 800-253-2532  
847-470-9595

Fax: 888-258-6657  
847-470-9696

sales@alfatools.com  
www.alfatools.com

## Solon Belleville Springs®

Ease of placing orders  
Friendly customer service  
Over 2,000 stocked sizes

Buyer's  
Choice



[www.solonmfg.com](http://www.solonmfg.com)



800-323-9717  
440-286-7149  
Chardon, Ohio

## DISTRIBUTOR NEWS

**Shear-Loc Products**, developers of the Original Instant Thumb Screw Knob have recently added a new laser engraved carbon fiber look that will add a technical touch to your product. The carbon fiber design can stand alone or be combined with your custom requirement.



The new carbon fiber design is an addition to the companies standard "Info Guide Series" that offers you 14 standard options to instruct, inform or give warning to the customer at the point of use. This approach not only works but it also gives a professional finished look to your product.

Shear-Loc also offers custom laser engraving on their entire line of black inch and metric thumb screw knobs. Custom artwork can be sent via e-mail in the form of jpeg, tiff or PDF with a minimum resolution of 150 dpi although 300 dpi is ideal for the highest quality mark.

For more information or for free samples contact Shear-Loc at Tel: 1-800-775-5668, Fax: 949-768-8705 or email: [sales@shear-loc.com](mailto:sales@shear-loc.com) Their entire line of thumb screw knobs can be seen at [www.shear-loc.com](http://www.shear-loc.com).

\* \* \*

**Detroit Washers & Specials** named Bob Elam quality manager and received ISO/TS 16949:2009 certification.

Detroit Washers, a division of MH Industries Ltd., is a domestic manufacturer of industrial washers, shims, spacers and specialty stampings for automotive, appliance, military, and aerospace industries.

For more information contact Detroit Washers at 32235 Industrial Rd., Livonia, MI 48150. Tel: 734-261-2600 or 1-877-694-0412 or on the web at [www.detroitwasher.com](http://www.detroitwasher.com).

SS Fasteners  
**Mehta Trading Intl.**

The Complete  
**Stainless Steel**  
Fastener Source for  
**MILL Shipments**



Mehta  
Trading  
International

For Competitive quotes, call us at  
888-324-6974  
Fax RFQ at 972-642-1244 or  
e-mail [corp@MehtaTI.com](mailto:corp@MehtaTI.com)  
Visit us at [www.MehtaTI.com](http://www.MehtaTI.com)

**Where Pursuit of Progress  
is Endless**





**ALBANY**  
STEEL & BRASS CORP.

1900 W. Grand Avenue, Chicago, IL 60622  
Toll Free: 866•803•3890  
Fax: 312•733•9887  
www.albanysteel.com



# From Stock!

## Specialty Tapping Screws

Type "B", "F", "U", "21",  
TEKS®, SWAGEFORM®

#00 Through 3/8"  
Diameters to 6" Long

**We Specialize in Large  
Diameters – 1/4", 5/16", 3/8"**

2500 Sizes Sold in  
Convenient 100 or  
1000 Packs

## Thumb Screws

**Cold Forged Steel**  
6-32 Through 3/8-16  
to 3" in Length

Plain (No Shoulder) and  
Shoulder Type  
1/4-28 and 5/16-24

**Now in Stock**  
Zinc Plated and Plain  
Finish

## Wing Nuts

**Cold Forged Steel**  
**Plain and Zinc Plated**

Including 4-40, 12-24,  
1/4-28, 5/16-24,  
3/8-24, 1/2-20

## SWAGEFORM®

High Performance Thread  
Forming Screws

New Sizes Are Constantly  
Being Added

**Now in Stock**  
4-40 Through 3/8-16 to 1-1/4" Long

All Popular Head Styles Including:  
Slotted Hex Washer Head, Unslotted Hex  
Washer Head, Phillips Pan Head,  
Slotted Pan Head, Phillips Flat Head

TEKS® is a registered trademark of ITW

SWAGEFORM® is a registered trademark of Black & Decker

**NOW AVAILABLE "OFF-THE-SHELF"**  
**NO LEAD TIME**  
**1,000 pieces and up**

## **PARKER-KALON®** **Plasti-Kwick Plus™** *The Ultimate Screw for Plastics*

Compatible with the hole sizes used  
by the leading screw in the market

- Superior Performance in Type PT® Screw Hole Sizes
- Competitively Priced
- High Pull Out Resistance
- High Strip Out Torque
- Reduced Installation Drive Torque and Hoop Stress
- Available in both Torx® and Phillips recesses

Plasti-Kwick Plus™ is a registered trade mark of Parker-Kalon  
Parker-Kalon™ is a registered trade mark of Black & Decker  
Torx® is a registered trade mark of Camcar  
PT® is a registered trade mark of EJOT® Fastening Systems

## NATIONAL INDUSTRIAL FASTENER &amp; MILL SUPPLY EXPO

# VEGAS FASTENER EXPO NEARS 750 EXHIBIT SPACES: LARGE BUYER TURNOUT EXPECTED

34 North High Street • New Albany, OH 43054 • Phone 614-895-1279 • Fax 614-895-3466 • www.fastenershow.com

The 16th National Industrial Fastener & Mill Supply Expo scheduled for October 10-12, 2012 at the Sands Expo & Convention Center, Las Vegas, Nevada USA is on track to be the largest since 2008, it was reported here today by Susan A. Hurley, CEM, General Manager.

"This is, by far, our strongest start since 2008 with 580 companies and 745 exhibit booths already under contract. These numbers include 65 companies which are either completely new to the Expo or are returning after an absence of at least two years. This means there are lots more products and services for distributors to see and buy. In addition, the greatly expanded Machinery & Tooling World area is brimming with exciting equipment and we continue to grow the amount of mill supply products offered such as abrasives, air compressors, cutting tools, drills, hand tools, plant maintenance and safety supplies, etc. of interest to today's multi-line distributors. These are all very positive signs of a recovering industry. We continue to receive exhibit space applications and inquiries on a daily basis and fully expect the 2012 Expo to well exceed last year's event in both size and buyer attendance", informs Ms. Hurley.

The 1 and 1/2 day Expo includes exhibiting companies from throughout the USA as well as 17 other countries including Belgium, Brazil, Canada, China, Denmark, Germany, India, Israel, Italy, Japan, Korea, Mexico, Singapore, Spain, Taiwan, United Kingdom and Vietnam. "We have the largest number of international companies ever represented in the Expo's proud 32-year history, making this a major, global, industry event not to be missed", comment Jim Bannister and Mike McGuire, General Partners.

## Conference

As usual, the Expo will not only showcase the very latest products and services offered by domestic and international companies but, also, provide a full day educational conference on Wednesday, October 10.

The Fastener Training Institute is conducting a

Fastener Technology Workshop from 8:30 a.m. to 4:30 p.m. The workshop will be led by Bengt Blendulf, one of the most dynamic and experienced fastener instructors in the US and Europe. This fact-and-fun filled day will focus on the practical aspects of working in the fastener industry. You will learn how to respond to technical



questions from engineers and technicians and how to find the answers. Workshop registration is open to everyone. Registration fees are \$299 for Fastener Association Members and \$399 for non-members. These rates increase by \$100 after August 26.

The Pacific-West Fastener Association is sponsoring a program on "Protect Your Company! Technical Knowledge Policies as a Risk Management Tool" from 2:00 p.m. to 4:00 p.m. The speaker is Carmen



Vertullo, CFS, a developer and lead presenter of the Fastener Training Institute's Certified Fastener Specialist training program. The program addresses how to put technical knowledge policies to work to keep your customers happy, protect your profits, and most importantly, limit your liability. Registration for this program is open to anyone. Registration fees

are \$100 for Fastener Association Members and \$150 for non-members. These rates increase by \$50 after August 26.

Women in the Fastener Industry (WIFI) will have a meeting and program on "Women in Leadership: An Evolving Perspective" from 2:00 to 4:00 p.m. The speaker is Sandra L. Cardillo, President of Conrad Associates, LLC. Sandi consults with both profit and not-for-profit organizations applying Accountable Management principles in structuring, talent management and improved managerial practices leading to increased profits. Registration for the program is \$15 for WIFI members and \$25 for non-members.

The Fastener Industry Finance, Controllers, Credit & Accounting Managers Meeting will be held from 9:00 a.m. to 3:00 p.m. This meeting is presented by the National Fastener Industry Finance Manager Network & the Business Credit Management Association. Financial

*please turn to page 178*

# Industrial Jewelry

AMPG  
A303  
AMPG  
A316  
AMPG  
A405  
AMPG  
A112  
AMPG  
A661

[www.ampg.com](http://www.ampg.com)

MADE IN USA

Come see us in October at the  
National Fastener Show  
Booth 1814



**Accurate Manufactured Products Group, Inc.**  
8090 Woodland Drive, Indianapolis, IN 46278  
Phone: 317-472-9000 • Fax: 317-472-9010  
email: [sales@ampg.com](mailto:sales@ampg.com)



## Barnaby Myhrum

Barnaby Myhrum is an Applications Engineer at Applied Bolting Technology in Bellows Falls, VT. He has over 25 years of experience in engineering and manufacturing companies in roles as an engineer, manager, executive and consultant. He earned a Bachelor of Science in Mechanical Engineering from the University of Vermont, and a Masters of Business Administration from Carnegie Mellon University. He can be reached by email at barnabym@appliedbolting.com.

## APPLIED BOLTING SQUIRTERS™ IMPROVE CONSTRUCTABILITY

Applied Bolting Technology sells over one million Squirter™ DTIs each month. The best EPCs in the world gladly pay a little more to include them in their fastener assemblies. Why? There are many reasons, but it all adds up to CONSTRUCTABILITY. Squirter™ DTIs make the work on a construction site easier and more efficient. Put another way, our customers save money and improve quality when they use our products.

Squirter™ DTIs guarantee that fastener assemblies achieve desired tension regardless of the torque required to get there. The relationship between torque and tension varies considerably depending on many factors: manufacturing tolerances, coatings, lubrication, job site conditions, installation tool, etc. Squirters™ are immune to these variations. When the installer sees the proper amount of squirt media, the bolt is properly tensioned. This ease of installation and inspection improve constructability.

### Squirters™ Guarantee Target Tensions +/- 10% with a 97.7% Confidence Interval

Squirters™ are accurate, too. In 2009, Applied Bolting Technology engaged Germanischer Lloyd to evaluate our larger Squirters™ designed primarily for the wind energy market. After a remarkably thorough evaluation, we received a GL certificate stating that our M36, M42 and M48 Squirters™ guarantee that target bolt tensions can be achieved +/- 10% with a confidence interval of 97.7%. This was not surprising to us, but it is gratifying to have a world-renowned consultancy and certification authority provide affirmation. Their test criteria were rigorous to say the least. The testing consisted of (a) a five piece calibration exercise, and (b) blind

tests of eight pieces performed as follows:

(a) For each size/grade to be certified, five pieces were compressed in a Skidmore Wilhelm load cell. The operator observed the volume and appearance of the squirt media at the target clamp load.

(b) The operator then performed blind tests of an eight piece sample (per EN ISO 3269, .65 AQL) of the DTI to be certified. During these tests, the gauge measuring the clamp load was covered so that the operator could not see the loads achieved. The operator tensioned the bolt based on squirt appearance



An M36 Euro Squirter installed in a wind turbine flange.

alone. A person other than the operator recorded the test values with no feedback to the operator.

The data was analyzed and blessed by Germanischer Lloyd. As shown in table 1, in all cases the 97.7% confidence interval was within a +/- 10% range around the target tension. These results were achieved using squirt appearance alone with no feedback to the operator. Ease of installation and inspection combined with a high level of accuracy all contribute to improved constructability.

Table 1: Squirter™ Blind Test Results

Size	Grade	Specifications			Blind Test Results			
		Min Tension (kips)	Max Tension (kips)	Target (kips)	Mean (kips)	97.70% C.I. (kips)	C.I. Min (kips)	C.I. Max (kips)
<b>GL Certification Tests: 2/2009</b>								
M36	"Euro"	111.6	136.4	124	130.4	5.37	125.0	135.7
M36	8.8	102.6	125.4	114	114.8	3.54	111.2	118.3
M36	10.9	127.8	156.2	142	145.6	11.2	134.5	156.8
M42	10.9	157.5	192.5	175.0	177.9	5.04	172.8	182.9
M48	10.9	207.0	253.0	230.0	227.8	6.68	221.1	234.4
<b>Customer 1 Tests: 11/2010</b>								
M24	10.9	55.1	66.3	60.7	63.1	2.71	60.4	65.8
M27	10.9	71.3	85.4	78.5	79.8	1.38	78.5	81.2
M30	Non-Std	81.2	97.6	89.5	91.0	3.12	87.9	94.2
M36	10.9	133.8	153.8	143.9	143.0	4.43	138.6	147.5
<b>Customer 2 Tests: 5/2012</b>								
M36	10.9	133.8	153.8	143.9	144.0	5.37	138.6	149.4

# It's not Finished 'til it's Fastened!

Flat Head and Button Head  
Barrel Bolts—  
new Large sizes  
in Stock

"Too Tall" Acorn Nuts—  
the finishing touch for  
construction projects

**MADE IN USA**

[www.ampg.com](http://www.ampg.com)

Come see us in October at the  
National Fastener Show  
Booth 1814



**Accurate Manufactured Products Group, Inc.**  
8090 Woodland Drive, Indianapolis, IN 46278  
Phone: 317-472-9000 • Fax: 317-472-9010  
email: [sales@ampg.com](mailto:sales@ampg.com)



TONY MENHISE

TONY

NUCOR  
FASTENER  
DIVISION

**NUCOR**<sup>®</sup>  
FASTENER DIVISION

WITHOUT VALUE,  
THE CUSTOMER IS ONLY LEFT WITH PRICE.

As one of America's largest fastener companies, owned and operated right here in the United States, we understand what holds our customers' businesses together. Value, it's an ever-changing equation that measures adherence to specifications, short lead times, customer service, price, and on-time delivery. Our solution is to put together quality fasteners with world-class customer service. Always outperforming overseas competitors by making ourselves available and accountable. Because no matter how you measure value, accountability is always the common denominator.

— | Visit [nucor-fastener.com](http://nucor-fastener.com) or call 1-800-955-6826 | —



*It's Our Nature.*<sup>®</sup>



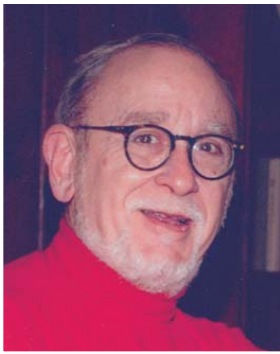

## Woodruff Imberman

An economic historian by training, the author, Dr. Woodruff Imberman, is President of Imberman and DeForest, Inc., management consultants. He has published many articles in *Distributor's Link* on improving managerial effectiveness, supervisory training, improving employee productivity, and on implementing Gainsharing Plans in the fastener industry. For further information on these subjects and the articles, please contact him at Imberman and DeForest, Inc., [IMBandDEF@aol.com](mailto:IMBandDEF@aol.com).

## THE PERILS OF PROSPERITY

Most fastener producers think happy now; the worst is over, business is good! The Great Recession of 2008-2009 is a thing of the past – a bad dream, only faintly remembered.... Think again.

Take automobile production – the engine driving the American economy, and the purchaser of roughly 25 percent of the fastener industry's output. In 2010, auto makers built 13.62 million automobile and light trucks in the US, up nearly 33% from 2009's low of 9.17 million, according to the US Department of Transportation. That's good, right? Think again.

Think back to 2005. Then, domestic auto and light truck production was 15.9 million – about 42% higher than 2009, and 14 percent higher than in 2010. Although 2012 production is predicted to improve to perhaps 14 million cars and light trucks, the American economy still struggles, unemployment is stuck at nearly nine percent, productivity is declining, home values are still tanking, and consumer confidence is in the cellar. And Washington continues to fiddle. It has nothing on Nero!

### Who Buys Fasteners?

Fastener industry prosperity depends upon the world's Original Equipment Manufacturers (OEMs). Most fasteners are highly engineered to OEM specs, and are used to hold together the products made by the automotive (25% of total fastener use), farm and construction equipment (15%), aerospace (14.4%), industrial machinery (13%) fabricated metal products (9.9%), electrical/electronic equipment (8%), as well as consumer durables like refrigerators, washing

machines, and other big-ticket items (7%). Cheap Far Eastern commodity fasteners for home improvement do-it-yourselfers jobs are the industry's only end-products - - minor compared to the OEM markets. (SEE: "Why Detroit's Past Is Important To Your Future," *Distributors Link*, Winter, 2009)

In their efforts to control expenses, the big specialty fastener buyers – the major OEMs – continue their global squeeze on suppliers. That trend is intensifying as OEMs face slack worldwide demand and politicians everywhere dither in their efforts to revive slack national economies.



### The World Outlook Today

In the United States, Washington continues to dodge the nation's continuing deficit problems caused by the Great Recession. Widespread concern about future governmental red ink, high unemployment, slack demand, and ever-sinking home prices mean low consumer confidence – and purchases. Few believe Washington will do much of anything to boost revenues (read more taxes) and/or cut spending (read cut defense outlays) until after the Fall elections...if then. So, fastener makers...don't look to Washington for a quick fix.

In Europe, politicians mumble bailout as the 17 Euro-using nations watch the Euro crumble as their national economies stumble. Poles there are reluctant to okay the trans-national fiscal union needed to make a monetary union effective. That won't happen until European nations cede economic sovereignty to a supranational authority. Fat chance of that! So, fastener makers....don't look to Europe for a quick fix.



GET THE 'ALL-METAL'

# LOCKNUT

*Advantage*

SEE US AT  
NIFMSE VEGAS  
BOOTH #913

HIGH  
QUALITY

ON-TIME  
DELIVERY

ISO 9001:2008

TECHNOLOGY  
DRIVEN

PRODUCT  
VARIETY

CONFORMING  
TO IFI 100/107

MADE IN  
THE USA

ENGINEERING  
SUPPORT

EXTENSIVE  
INVENTORY

**LOCKNUT  
TECHNOLOGY INC.**

**OUR NAME SAYS IT ALL**

LOCKNUT TECHNOLOGY INC. 351 South Lombard Road, Addison, Illinois 60101  
Tel: 630-628-5330 Fax: 630-628-5331 Email: sales@locknuttechnology.com Web: www.locknuttechnology.com





Manufacturing Domestic  
Fasteners for over 30 years!

### Hot Forging



Structural Bolts	Flat Head Bolts
Hex Bolts	Square Head Bolts
Carriage Bolts	Round Head Bolts
<hr/>	
<i>Carbon Steel</i>	<i>Stainless Steel</i>
A307	304, 316, B8 B8M
A325	A320
A449	A593

### Anchor Bolts & Threaded Rods



Threaded Studs	Bent Anchors
Fully Threaded Rods	Straight Anchors
Double Ended Studs	Welded Anchors
Acme Studs	Headed Anchor
Chisel Point Studs	Special Radius Anchors
<hr/>	
<i>Carbon Steel</i>	<i>Stainless Steel</i>
F1554 Gr 36	304, 316, B8, B8M,
F1554 Gr 55	A320,
F1554 Gr 105	A593
A193-B7	

### Custom Fasteners



Socket Screws	Coupling Nuts
Slotted Screws	Jam Nuts
Shoulder Screws	Special Size Nuts
Flat Washers	



ISO 9001:2008 Certified

Phone: 1-800-711-0830

Fax: (763) 493-3214

Email: sales@EA-Products.com

Web: www.EA-Products.com

11885 Brockton Lane North  
Maple Grove, MN 55369

## DISTRIBUTOR NEWS

### CSM Fastener Products

a cold heading manufacturer of Inch and Metric Fasteners made to IFI, DIN, ISO and JIS standards. We will manufacture small volumes as well as large quantities, whatever you need. We have NO MINIMUM QUANTITY. We have an in-house tool room and complete machine maintenance in order to provide the highest level of service to our customers. We have recently added new equipment to expand our capacity.

We can produce sizes #4 through 1/2" (M12), and lengths to 7" (177mm). Virtually all head styles and drive recesses are available. We manufacture machine screws, tapping screws, thread forming screws, sems screws and many other standards and specials.

We can deliver complete Quality documentation with PPAPs, IMDS submissions, SPC programs and reporting, certifications and fasteners for automation. We have recently added an in house high speed, three camera optical sorter to provide faster service for our customers that need auto feed quality.

We offer full CAD development, design sharing, design and development assistance and testing capabilities. We are an ISO 9001:2008 registered firm.

For more information contact CSM by phone at 630-592-1946, Fax: 630-350-8499 or on the web at [www.csmfastener.com](http://www.csmfastener.com).

*Your only*  
**FLANGE BOLT &  
NUT COMPANY**

**ASK FOR OUR LINE CARD:**

**NEW ITEMS**

- STAINLESS STEEL FLANGE BOLTS IN METRIC and ½" DIAMETER

**STANDARD IN STOCK ITEMS**

- GRADE 5 AND 8.8 SERRATED HEX FLANGE BOLTS
- GRADE 8 AND 10.9 HEX FLANGE BOLTS
- STAINLESS STEEL 18.8 FLANGE BOLTS
- FLANGE NUTS – SERRATED, NYLON INSERT, STAINLESS STEEL, LARGE FLANGE, TOP LOCKED, AND UNLOCKED
- SPECIAL ORDER FLANGE BOLTS

We offer the largest selection, competitive pricing and on-time delivery backed by our extensive, diverse inventory with unmatched customer service!

*Call or fax your order today:*

**ICS**  
**FLANGE**

PH: **800.231.0360**

FX: **800.586.2461**

10729 Wolf Drive, Huntley, IL 60142

[www.INNOVATIVECOMPONENTSALES.com](http://www.INNOVATIVECOMPONENTSALES.com)



(440) 546-0304

Fax (440) 546-0306



Large selection of  
light duty car & truck

# Wheel Nuts



info@glparts.com

www.glparts.com

## DISTRIBUTOR NEWS

**Anixter Fasteners** announced its L450,000 (US\$702,000) independent testing laboratory in Gloucester is commissioned and is independently audited.

"We support the largest OEMs, including a large proportion of the automotive industry," Anixter vice president of technical services Richard Hawker explained. "The fasteners and components that we supply are therefore often application critical, for example in chassis build or construction of braking assemblies."

"At A-lab in Gloucester we offer over 25 different tests to scrutinize the integrity of a huge array of components," metallurgist Lee Pugh noted. Testing includes metallurgical, mechanical, chemical, failure investigation and product finish and BS, ISO, ASTM and Ford standards.

For more information, contact them at 2301 Patriot Blvd., Glenview, IL 60026. Tel: 224-521-8000 or visit us on the web at [www.anixter.com](http://www.anixter.com).

\* \* \*

For the first time in its history, **Alcoa Fastening Systems** is announcing that the Huck brand of fasteners and tooling will be available through open distribution.

The new plan offers three levels of distributor involvement: Tiers 1, 2 & 3.. Tiers are assigned based on levels of product support, sales requirements, training participation, and other services. "With open distribution we're increasing the availability of our entire product line. Single-point ordering and clear-cut field support is going to be better for everyone," stated Michelle Hanley, Distribution Program Manager for Alcoa Fastening Systems.

Distributors will now have a choice of purchase locations. They may continue to purchase Huck brand product from other distributors, or purchase directly through the AFS warehouse in Tracy, CA. Select Huck products will be made available at the Tracy warehouse for small orders.

For more information contact Alcoa Fastening Systems at 8001 Imperial Drive, Waco, TX 76714, call 1-800-388-4825 or go to the website at: [www.afsindustrial.com/distribution](http://www.afsindustrial.com/distribution).



**MRO Distributor  
Supply Warehouse**

*Order Only What You Need & Get It  
Right Away !*

***We Inventory Over 25,000 MRO  
Supply Items, So You Don't Have To.***

- *Small Minimum Order*
- *Flexible Fastener Packaging*
- *Broken Case Quantities, OK!*
- *Drop Ship Your Orders*

*No Franchise Agreement & No Contract to Sign*

**436 Page  
MRO Sales  
Catalog -  
Yours FREE !**



**Use In The  
Field As Your  
Sales Catalog**

***Also Available:***  
Generic Catalog  
with loose pages.  
No Cover, No Name.

[www.usaSupplyLine.com](http://www.usaSupplyLine.com)

Setup an account to see Distributor Pricing

Call: 1-800-44-SARJO - Fax: 845-454-0070

Drills • Taps • Reamers • End Mills • Annular Cutters • Burs

# DRILLCO

The Home of the Nitro



Incorporated in 1978, Drillco has been supplying industry with the finest selection of quality metal cutting tools, manufactured in America and around the world for over 25 years.

Selling exclusively through over 2000 distributors in the U.S. and abroad, Drillco offers a complete selection of domestic and imported metal cutting tools, including Drills, Taps, Dies, Reamers, Burs, Annular Cutters, End Mills, Masonry Drills, and much more. Our large selection of tools, located in shipping locations in Baton Rouge, Indianapolis, Los Angeles and Kansas City, combined with our state of the art manufacturing facilities, makes Drillco the best choice for all your cutting tool needs.

Please visit our website: [www.drillcocuttingtools.com](http://www.drillcocuttingtools.com) to browse through our extensive product line, and then contact us at 1-800-851-3821 or e-mail [sales@drillcocuttingtools.com](mailto:sales@drillcocuttingtools.com), to discuss how we can meet your requirements.

13011 South Choctaw Drive, Baton Rouge, LA 70815

## PACIFIC-WEST FASTENER ASSOCIATION

# PAC-WEST FALL CONFERENCE: SCOTTSDALE, ARIZONA - NOV 8-10, 2012

Learn and grow. Challenge and inspire. Lead and succeed. The possibilities are endless.

At the Pac-West 2012 Fall Conference, you'll engage with thought-provoking speakers, experience innovative session formats, enjoy the camaraderie of your fastener friends, and much more.

## Conference Education

### • **Fastener Basics Workshop**

The difference between you and your competition is employee skill, knowledge and productivity. It is the people you employ who will lead your company into the economic upturn. Their commitment, productivity and ability to add value will keep you competitive.

This unique class, offered for the first time in Northern California, will provide valuable, fundamental information to help your team communicate with your customers and give you a competitive edge.

Course content includes:

- o Basic terminology
- o How to call out parts
- o Methods of manufacturing
- o Coatings and finishes
- o Hydrogen embrittlement
- o Consensus standards
- o How to use the IFI Manual
- o Fastener Quality Act

This pre-conference workshop is not included in the conference registration fee. You can register individually for the workshop without having to attend the full conference.

### • **Critical Fastener Technical Issues**

Keeping up with everything you need to know about fastener specifications, standards and technology is a daunting task. Fortunately we have Joe Greenslade to keep us informed about critical issues that can have a big effect on our business bottom line.

- What kinds of regulation should we be anticipating?
- RoHS and REACH –Is anyone truly monitoring this? Where's it going? Are there RoHS police?
- Certificates of conformance, certificates of compliance Are they worth anything?

Should we (as distributors) author them?

- What kinds of quality audits should we consider for our suppliers? What should we ask our suppliers in order to be diligent buyers?

Joe Greenslade has been active in the fastener industry

since 1970. He has held positions with major fastener producers in sales engineering, marketing, product design, manufacturing management, and research and development management. Currently Joe is director of engineering technology for the Industrial Fasteners Institute.

### • **Prospecting: Call Plans, Strategies and What to Say to Expand and Develop Business**

Prospecting remains one of the most critical, cost effective activities to create opportunities, deepen relationships with current customers, and expand market share. Training your team to see potential opportunity and consistently ask meaningful questions can transform performance and increase revenue.

Learn:

- How to develop a call plan
- Create discipline and goals around calling
- Craft meaningful questions for your target audience
- Create a follow up plan
- How to start a prospecting call
- How to close a prospecting call

Enhance your Fall Conference investment by signing up for one of the limited-availability free consultations with Ann marie Houghtailing after the morning program.

Ann marie Houghtailing, a sales trainer, business strategist, motivational speaker, and entrepreneur who has trained thousands of professionals to increase revenue.

### • **Business Owners Forum**

This is perhaps one of the best benefits of membership in the Pacific-West Fastener Association and always one of the most highly rated sessions of every conference. You and your peers will share experiences and solutions in a frank interchange. You can submit topics for discussion in advance or jump in during the session.

### • **Business Executives Workshop: Emotional Intelligence for Leadership Influence**

We're doing something different for Business Executives this time. Instead of an open forum discussion, we're bringing in a professional development program to recharge your leadership skills.

While individuals at your company may be currently functioning at high levels, this program represents an opportunity to use leading-edge thinking to continue to get to the next level of performance. It will provide you with tools and strategies to increase your ability to manage yourself as well as manage the critical relationships that exist between you and the people around you.

*please turn to page 195*

# SPIROL®

Visit us at  
Booth 522  
National Industrial Fastener  
and Mill Supply Expo  
October 10-12, 2012  
Las Vegas, Nevada USA

Enhance product quality,  
simplify assembly and  
reduce your total cost.

**COILED SPRING PINS**  
**SLOTTED SPRING PINS**  
**INSERTS FOR PLASTICS**  
**COMPRESSION LIMITERS**  
**ALIGNMENT DOWELS / BUSHINGS**  
**SPECIALTY WASHERS**  
**PRECISION SHIMS**  
**DISC SPRINGS**  
**THUMB NUTS**  
**PANEL NUTS**  
**CAP NUTS**  
**HEX NUTS**  
**SPACERS**



Tens of thousands  
of standard parts:

- Available to ship from stock
- No tooling charges
- RoHS and DFARS compliant
- MS/NASM & NAS certified parts



[www.spirol.com/s/overview-link/](http://www.spirol.com/s/overview-link/)

**SPIROL.com**

P 800.321.4679  
F 860.774.0487

Certified to:  
ISO/TS 16949:2009  
ISO 9001:2008  
AS 9100:2009  
Nadcap AS7108 Chemical Processing  
Nadcap AC7116/4 Nonconventional Machining

**Over 60 years of  
manufacturing experience**

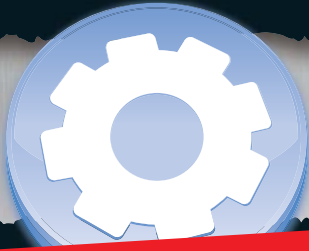

**Computer Insights Inc**  
**108 Third Street, Bloomingdale, IL 60108**  
**Tel: 1-800-539-1233 Email: sales@ci-inc.com**  
**www.ci-inc.com**

## FREE The BUSINESS EDGE 2.0 SYSTEM AT NIFMSE VEGAS

### COMPUTER INSIGHTS DOES IT AGAIN!

Dennis R. Cowhey (Denny), CEO of Computer Insights, Inc., maker of the **The BUSINESS EDGE 2.0** surprised the industry announcing that they will give away another FREE SYSTEM as a prize in a contest at the National Industrial Fastener and Mill Supply Expo in Las Vegas. The drawing will be on the show floor in the Computer Insights, Inc. booth at noon on Friday October 12th. They did this last year to celebrate their 30th anniversary, but Denny said that the response to the contest was so overwhelming; they decided to do it again. The system can be up to 50 users. It is completely FREE. It even includes one year free hardware and software maintenance. The winner does not need to be present to win.

#### *Last Year's Winner - Perfect Lock Bolt America, Inc.*

As a last minute entry (they filled out the form on their iPad on the show floor), Perfect Lock Bolt America, Inc. was surprised and pleased with their good fortune. Mark Doll, President and CEO, said "The system is simply amazing. While we were exhibiting at the show, we were also there with the goal to source a fastener-specific accounting system, and an inventory management solution. **The BUSINESS EDGE 2.0** is all of that and much,

much more. It does more than we would have ever imagined. We're beyond pleased with the features, training and support that Computer Insights has provided."

#### *Entering The Contest is Easy*

Companies can qualify for this contest by filling out a short survey form at [www.ci-inc.com/survey](http://www.ci-inc.com/survey). Filling out this form will help the distributor discover what **The BUSINESS EDGE 2.0** can do for them. It will also give Computer Insights the ability to determine if **The BUSINESS EDGE 2.0** is a good fit for the client.

Denny said, "We put all our bets on the Fastener Industry and the industry has been very good to us. This is our way of giving back. The prize has no cash value, but for someone who needs a new system it is a great opportunity."

#### *Complete System*

The FREE system includes everything the company needs. It includes an IBM Server, User Licenses for up to 50 concurrent users, an Uninterruptible Power Supply and unlimited free training and support. It also includes a year of online backup service. It even includes free programming of all the custom business forms that the system produces. All the business forms (Quotes, Invoices, Requests for Quote, etc.) can be E-mailed, faxed or printed. The only exception is that Windows PC's, Apple or Ubuntu workstations, printers and other peripherals are not included with the free system. The system is for the exclusive use of the winning company and cannot be transferred to another company. Only one entry is permitted per company.

## The BUSINESS EDGE 2.0



*please turn to page 238*



# WROUGHT WASHER

**Special Washers & Stampings**

**TS Registered Quality System**

**Domestically Produced Standard Washers**

*Special Flat Washers-Long & Short Runs*

*Laser Cutting/CNC Machining*

*Heavy Stampings up to 1/2" Thick*

*Sems Washers*

*9,000,000 lbs Raw Material In-house*

*Direct Shipments or Managed Inventory*



*F436 Structural Washers, Type 1 up to 3 inch, Type 3, Bevels and .312 Thick*

*Mil-Carb,™ MC2, MCX Washers, High-Strength USS/SAE*

*Helical Spring Locks, Regular, High Alloy, Heavy, Metric, Hi-Collar*

*Domestically Produced Quality Grade 2 Washers, USS/SAE & Fender Washers*

*Import Grade 2 Washers*

*Auto Shims, U-Bolt, Type B Washers*

## REGIONAL WAREHOUSES

**Milwaukee Dallas Tampa  
Houston Charlotte Santa Fe Springs**

**1-800-558-5217**

**www.wroughtwasher.com**

A T L O B E Y E D E G R O F C  
 E U R I B B E D N E C K S L L  
 R B U T T O N H E A D O R K I  
 O U P W A S E L O H C T T W P  
 S L I D X F L A N K Y R E E P  
 P A T T U G G I E E S U S R E  
 A R H L L T C T K E R S S C D  
 C R C O K K S F P G E S S S W  
 E I N B S C F R G A I H E G A  
 R V E U R U G G E G L E L N S  
 I E R E R S T N E D P A D I H  
 V T W D R E B M A C N D A P E  
 E S O C H A M F E R Z U E P R  
 T O D X N I P L E W O D H A X  
 W H E A V Y H E X N U T Z T C

## FASTENER WORDSEARCH

*Can you find and circle in the grid above, the terms listed below?*

- Aerospace rivet
- Button head
- Camber
- Chamfer
- Clipped washer
- Dents
- Dowel pin
- Flank
- Forged eye bolt
- Gage
- Headless set
- Heavy hex nut
- Hole saw
- Lap
- Nicks
- Pit
- Pliers
- Ribbed neck
- Rod
- Socket screw
- Tapping screw
- Thunder stud
- Truss head
- Tubular rivet
- U-bolt
- Woodruff key
- Wrench

*Solution on Page 25 I*



### **Cable Tie Express, Inc.**

15470 Endeavor Drive, Noblesville, IN 46060

Tel: 1-888-603-1233 Fax: 1-800-395-1233

Email: sales@cabletieexpress.com

www.cabletieexpress.com

## **CABLE TIE EXPRESS...AT YOUR SERVICE!**

"Stop! It's a Kodak moment!" Such were the words of one dear to all of us LINK readers - Tracey Lumia.



What caught her eye and subsequently spurred the clicking of Tracey's camera to capture this photo? You got it - cable ties, the remarkable product that touches our lives in many ways....and this time SERVICING motorists by increasing awareness of a stop sign in Juneau, Alaska.

A rather quirky way to begin a news story?

Perhaps but it clearly demonstrate just how far reaching cable ties are in life. More importantly, however, it is a statement of how important SERVICE is to success and fulfillment in business and life.

Cable Tie Express, a leading supplier of cable ties, heat shrink tubing, wire nuts, cable clamps, and mounting bases, has taken this element of service to heart and recognizes how far reaching SERVICE truly is.

"Providing that key element of service extends through many facets of our lives at Cable Tie Express and goes well beyond the course of action we try to take with every one of our valued customers," Char Cooper, President of Cable Tie Express, recently commented.

### **SERVICE.....to families and friends.....**

With a solid team of employees who hang their hats each day at Cable Tie Express and incorporate over 85 years of experience in the fastener industry, SERVICING the Cable Tie Express family through sport sponsorships,

charity donations for personal and benevolent causes, and furthering educational pursuits are all part of the offerings to the staff at the Company.

### **SERVICE....throughout the community..... and miles down the road...**

Check out the youtube video found at the link <http://www.youtube.com/watch?v=KGf0NsRysME&feature=youtube> to see the

results of a mixture of 13,000 cable ties, children and adults of all ages, the transformation of an empty bicycle rack and light post, brilliant summer sunshine, and unleashed imagination - certainly SERVICING the community with a smile for a zip tie art project at the



Nickel Plate Arts Festival in Noblesville, IN. What a glorious day of community bonding, family fun and inspiring others through creativity and art!

Avidly supporting a major employer and one of the largest providers of food for those in need in Hamilton County, any one of the Cable Tie

Express employees or family members might be spotted supporting the efforts through collections of canned goods, participating in walk-a-thons, or providing sponsorships and matching gifts, all with the goal of SERVICE with that "Good Samaritan" spirit.

Stepping away from the Midwestern locale and recognizing the value of education, Cable Tie Express recently focused its SERVICE efforts with assistance in launching the first year of a charter school in New Orleans.

*please turn to page 215*



HEAT  
SHRINK  
TUBING

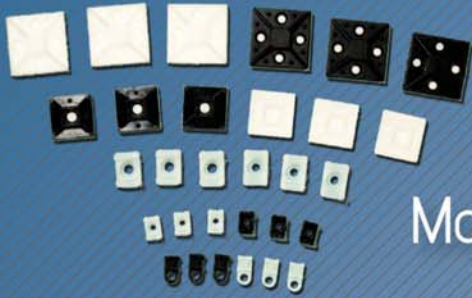

MOUNTING  
BASES



WIRE  
CONNECTORS



CLAMPS



CABLE  
TIES



ALL WAY

15470 Endeavor Drive, Suite 100, Noblesville, IN 46060  
888.603.1233 • Fax: 800.395.1233  
cabletieexpress.com • sales@cabletieexpress.com

**SEE US  
IN VEGAS  
BOOTH #834**

# MWFA 31ST ANNUAL FASTENER SHOW MEDINAH BANQUETS, ADDISON, IL - JUNE 26, 2012



# I SEE

A PIVOT POINT FASTENER



SOLUTION

# IN YOUR FUTURE

SEE FOR YOURSELF AT THE NATIONAL INDUSTRIAL FASTENER SHOW IN LAS VEGAS (BOOTH 1109)

Pivot Point is widely recognized for innovative engineering & progressive product development. Our solutions continue to evolve in response to customer demand for increasingly complex and unique fasteners. Whether you need stock or specialty Non-Threaded Fasteners, discover the good fortune of working with the industry leader.

## OUR NEWEST OFFERINGS:

## OUR UNIQUE INNOVATIONS:

### EXTENDED LOCKING PULL PINS



Patent Pending

### PRECISION MACHINED PARTS



### SLIC PINS™



Spring-loaded plunger retracts when inserted, then locks pin into place.

U.S. Patent No. 6,872,039  
Foreign Patents Issued

### BOW-TIE LOCKING COTTERS™



U.S. Patent No. 6,135,693 and D431,181

## OUR POPULAR FAVORITES:

### RUE RING™ LOCKING COTTERS



Our Original Design!

### NYLON LANYARDS™



U-Lock Style  
U.S. Patent No. 5,784,760

- Clevis Pins
- Ball Lock Pins
- Bent Arm Pins
- Steel Lanyards
- Ball Plungers/Spring Loaded Devices
- Quick Release Pins
- Locking Pins
- Grooved Pins
- Ring Pins

ALSO: PULL PINS • INFINITY S-HOOKS

**SPECIALS ARE OUR SPECIALTY!** We carry a variety of products and sizes in stock but we also excel at delivering personalized engineered solutions. We are superior at developing specific solutions for diverse applications. Challenge us and we'll respond. You won't need a crystal ball to see we are totally committed to customer service and satisfaction.

**PIVOT POINT**  
INCORPORATED  
NON-THREADED FASTENER SOLUTIONS

BE SURE TO REQUEST ONE OF OUR BRAND NEW CATALOGS AND VISIT OUR NEW WEBSITE TOO: [PIVOTPINS.COM](http://PIVOTPINS.COM)

HUSTISFORD, WI • USA • 800-222-2231 • 920-349-3251





### Tiger-Tight Corporation

2200 Arthur Kill Road, Staten Island, NY 10309  
 Tel: 718-356-3376 Fax: 718-356-3661  
 Email: bserabin@tigertight.com  
 www.tigertight.com

## SPACEX UTILIZED TIGER-TIGHT FRICTION WASHER TECHNOLOGY FOR FIRST MISSION TO THE SPACE STATION

Tiger-Tight, subsidiary of Precision Aerospace Components, proprietary friction washer technology was used by Space Exploration Technologies (known as SpaceX) on the Dragon spacecraft launched atop a Falcon 9 rocket from Cape Canaveral Air Force Station in Florida on May 22, 2012.

The Tiger-Tight technology operates on a micro-topographic scale. Industrial diamonds embedded in an electro-less nickel matrix penetrate and interlock with the mating surfaces to create an extremely high retaining force and prevent loosening under vibration and shock. See Diamond Matrix Graphic below.

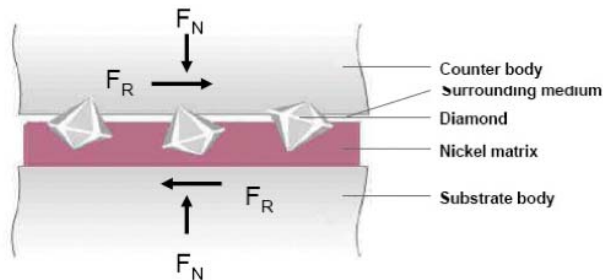

Because the interaction is at the micro level, there is no critical damage to the affected surfaces.

***Tiger-tight washers and shims promote safe, effective joints under static and dynamic load conditions by resisting loosening from external transverse loads and/or distributing the joint pre-load.***

Tests conducted on a Junker Vibration Test Rig, designed to impart transverse cyclic loads on a fastener joint, show Tiger-tight outperforms all other competitors tested.

JUNKER VIBRATION TEST -  
 SUBSTRATE MATERIAL ALMGSI1

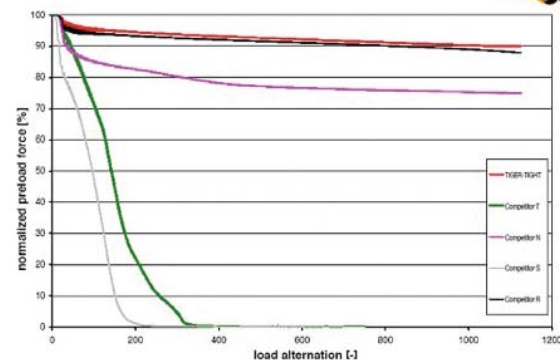

TIGER-TIGHT LOCKWASHER  
 A NEW JOINT LOCKING DEVICE

Tiger-tight Corporation is a subsidiary of Precision Aerospace Components, Inc. Tiger-tight is the North American master distributor of Tiger-Tight Friction Washers. Tiger-Tight washers promote safe, effective bolted joints under static and dynamic load conditions by distributing the pre-load and resisting loosening from external transverse loads. Its patented coating features industrial diamonds embedded in an electro-less nickel matrix that penetrate and interlock with the mating surfaces to create an extremely high retaining force and prevent joint relaxation. 



# AMERICAN IMPERIAL SCREW CORP

1-800-431-2391

Fax-845-354-4377

*THE FIRST CALL YOU SHOULD MAKE FOR HARD TO FIND FASTENERS*

Over 500 million screws in stock!

## **Cap Screws & Tap Bolts**

1/4" - 2" Diameter

## **Machine Screws**

0 - 5/8" Diameter,  
0-80, 1-64, 1-72, 2-64, 2-56, 3-56,  
3-48, 4-48, 4-40, 4-36, 5-40, 6-40,  
6-32, 8-36 & 8-32

## **Nuts**

Cap, Castle, Coupling, Finished, Flange,  
K-Lock, Machine, Pal, Panel, Slotted,  
Square, T-Nut & Weld

## **Pins**

Cotter, Dowel, Roll & Coiled

## **Bolts**

Carriage, Hanger, Lag & Square

## **Drive Screws**

Type U

## **Rivets**

Blind, Solid, Tubular

## **Screws**

Drywall, Particle Board, Deck, Thumb,  
Weld, Wing & Wood

## **Self Drilling**

## **Self Piercing**

## **Sems**

## **Sockets**

Set (Slotted & Hex), Flat, Button & Cap

## **Tapping Screws**

A-AB & B

## **Thread Cutting**

F, 23, 25 & 1

## **Thread Forming**

### **Authorized Distributor For:**

**BUMAX Stainless Fasteners**, - Equivalent to SAE J429 Grade 5 & 8

**ITW Shakeproof-SIP Push on Fasteners** - Push on Hats (axle caps), Push on Retaining Fasteners, Washer Faced Lock Nuts & Self Threading Lock Nuts

**Simpson Strong-Tie Anchors** - Adhesives & Mechanical Anchors

WWW.DISCOUNTSCREWS.COM

245 QUAKER ROAD, POMONA, NY 10970



### Vogelsang Corporation

1790 Swarthmore Avenue, Lakewood, NJ 08701  
 Tel: 1-800-526-2376 Fax: 732-364-8111  
 Email: sales@vogelsangcorp.com  
 www.vogelsangcorp.com

## NEW PRODUCTS, PEOPLE AND WAYS TO DO BUSINESS AT VOGELSANG

Vogelsang's 40th anniversary year began with a formal welcome to Nick Penney, National Sales Manager. Nick has over 25 years of sales management experience in the fastener and engineered components industry. Along with driving sales into new markets (targeting compression limiters and large diameter pins) Nick has already helped expand Vogelsang's present markets and is at the forefront of Vogelsang's re-commitment to customer service in 2012. "We've turned our customers' comments and suggestions into actionable items which are already improving customer service such as bringing back incremental pricing by diameter & length, and improving current delivery systems," explained Penney.



Working with Vice President & General Manager, Dale Stuban, and the entire sales team at Vogelsang, Penney has also set his sights on expanding inventory to keep up with ever-changing customer demands. To this end, Vogelsang's same-day shipment program — Quick Ship — has been expanded to offer customers even lower pricing on popular Rollpins®, spring pins, coiled pins and bushings. Starting in the first quarter of 2012, over 700 new line items were added, with new steel Rollpins® SKUs topping the list of new offerings. Spring pin SKUs have tripled including carbon steel plain, carbon steel zinc, 420 stainless steel and 18-8 stainless steel. Spring pins are also now stocked in inch and metric. "Our Quick Ship program and competitive pricing have helped us establish Vogelsang as the premier stocking manufacture in the fastener industry."

commented Stuban. Vogelsang production capabilities encompass four manufacturing plants located in the US and Europe.

As one of the world's largest producers of split metal products, their line consists of: Tension Pins, RollPins,® Coil Pins, Automotive Spring Pins, Large Diameter Pins, Military Pins, Tension Bushing, Split Tension, Bushings, Compression Limiters®, Spacers, Sleeves and AVS Cages



This anniversary year for Vogelsang has also included the launch of their new website. A visit to [www.VogelsangCorp.com](http://www.VogelsangCorp.com) will bring up a modern, sleek design with easy navigation, 24/7 pricing for Select Dealers, easy to find product information and specifications, rep locator,

press releases, an easy RFQ process and much more. "We wanted to design a site that was very comprehensive, yet easy to navigate with all the resources and tools our customers were looking for," explained Penney, adding "We will also provide continuing information for our customers on the site with monthly updates." Vogelsang has also established their presence in the Social Media world. "It's all part of adapting to how people do business today" explained Penney. Vogelsang encourages people to connect and keep in touch with Vogelsang online to stay informed about products, services and more. "Like" them on Facebook ([www.facebook.com/VogelsangCorp](http://www.facebook.com/VogelsangCorp)), "Follow" them on Twitter ([Twitter.com/#1/vogelsangcorp](http://Twitter.com/#1/vogelsangcorp)), and find them on LinkedIn. 







# You Spoke. We Listened.

**New ways of doing business to serve you better.**



Our new site design at [VogelsangCorp.com](http://VogelsangCorp.com)

When we surveyed our customers about what they wanted, they weren't shy. We heard them loud and clear. We're proud to now offer...

- **Incremental Pricing**
- **Better Customer Service**
- **Improved Delivery Systems**
- **Expanded Inventory**
- **More Steel Products**
- **Faster Turn-Around**

We've also launched our brand new website featuring a more user-friendly layout. And keep an eye out...we'll be coming to your area soon!



**VOGELSANG CORPORATION**  
Rolled Ideas — Wrapped Solutions



**BBC FASTENERS, INC.**  
**4210 SHIRLEY LANE**  
**ALSIP, IL 60803**  
**PH 708-597-9100**  
**FX 708-597-0423**  
**www.bbcfasteners.com**

**HOT FORGING, COLD HEADING**  
**CNC MACHINING**  
**IN-HOUSE TEST LABORATORY**

**ASTM, SAE, INCH OR METRIC**  
**MIL-SPEC**

**ESTABLISHED 1959**

## DISTRIBUTOR NEWS

**Intercorp.**, an importer of high quality construction fasteners under the Strong-Point® brand, is pleased to announce the addition of Aaron Renfro and Justin Estes, two new Account Managers that will work from InterCorp's Portland and Dallas branches.



"Intercorp has had an unprecedented period of growth over the last two years, and because of this, we have hired additional staff to help support that growth," said National Sales Manager Law Winchester. "Justin and Aaron bring a great deal of customer service skills and energy to InterCorp and will help us continue to provide outstanding service to our customers as the demand for our products continues to soar."

For more information, InterCorp can be contacted by Tel: 216-750-2265, Fax: 216-750-2266 or Toll Free: 1-800-533-9669. Visit them on the internet at [www.intercorpusa.com](http://www.intercorpusa.com).

## DISTRIBUTOR NEWS

**Fascomp Electronic Hardware** is a world leader in the business of supplying electronic hardware. Determined to continue to work towards business excellence, Fascomp has committed to achieving ISO Certification by year's end.

We have implemented a program (CANI - Constant & Never-ending Improvement) which enables us to develop, analyze and continually improve our systems, processes,

and personnel. The decision to meet the requirements of the ISO 9001 standard reinforces our commitment to excellence" – Mark Georgia, "This assures our customers of fine quality products and services that meet or exceed their needs, requirements, and expectations" - he continued..

For more information contact Fascomp, Tel: 407-226-2112; Fax: 407-226-3370; You can view our full line Catalog at [www.fascomp.com](http://www.fascomp.com)





### Z-Line Industrial Finishes

P.O. Box 1090, Menomonee Falls, WI 53051

Tel: 855-284-1164

Email: sales@raabeco.com

www.z-linehighperformancefinishes.com

## Z-LINE ANNOUNCES ITS NEW LINE OF MRO AEROSOLS

Z-Line Industrial Coatings, a company dedicated to providing full service solutions for the MRO professional, has launched its performance proven line of MRO cleaners/degreasers, enamels, lacquers, primers, welding supplies, and inverted paints to the industrial coatings market.

The Z-Line MRO line has a wide variety of products that are ideally suited for industrial as well as automotive, aeronautical, home, marine, ground marking and construction applications. These products are highly competitive and have been specifically developed to protect and restore an array of substrates. The entire

program consists of: high solids enamels, acrylic enamels, cleaners and lubes, spray lacquers, spray primers, athletic and field marking sprays, traffic striping sprays, and utility marking sprays.

"The all-new MRO aerosol program offered by Z-Line is designed to provide MRO professionals with multiple options for providing maximum protection through corrective and preventative maintenance as well as restoration," stated Steve Hughes, Business Unit Manager. "We are confident that our customers will be excited about the durability, spray characteristics, gloss and adhesion features, and fast dry times offered by

these performance proven products."

### About Z-Line Industrial Coatings

In 2010, Z-Line Industrial Coatings joined the Quest Specialty Chemicals family as a member of the Quest Specialty Coatings division. The addition of Z-Line has complimented the industrial and construction sectors by offering innovative solutions for the maintenance, repair, and operations of industrial machinery and equipment. The Z-Line product offering consists of a wide selection of paints and paint-related products, from general-purpose to specialty products to rust-preventative paints and primers. 



### Hard Working Products For Hard Working People.

Order Z-Line Today  
855.284.1164

H.S. Industrial Enamels  
H.S. Industrial Primers  
Alkyd Enamels  
Acrylic Enamels  
Lacquer Enamels  
Lacquer Primers  
Welding Supplies  
Marking Accesories  
Traffic Marking Paint  
Utility Marking Paint  
Athletic Field Marking  
Cleaners & Degreasers

 Proudly Made In USA



Z-Line Industrial P.O. Box 1090 Menomonee Falls, WI 53052  
www.z-linehighperformancefinishes.com

# DELTA SECONDARY



DRILLING • THREADING • CUTTING

*Offering Fastener Distributors over  
35 years of fastener related  
machining experience...*

- **Quality Machine Shop  
Serving Fastener  
Distributors**
- **Small or Large  
Quantities**
- **Hard to Find Items**
- **Special Prototypes**
- **CUT OFF & CHAMFER**
- **CUT THREADING**
- **CROSS DRILLING**
- **DRILLING & TAPPING**
- **TURNING**
- **MILLING**
- **SLOTING**
- **GROOVING**



**DELTA SECONDARY, INC.**  
1000 Industrial Drive  
Bensenville, Illinois 60106  
Tel: 630.766.1180 Fax: 630.766.1285

**EMAIL: DELTA911@MSN.COM**

**YOU FOUND IT!**

**SELECTION**

MANY SIZES AVAILABLE 8" OD TO .500 THICK  
ISO 9001 "2000

**ALL TYPES**

MOST METALLIC & NON-METALLIC MATERIALS

**ON HAND**

STOCKING MANUFACTURER  
SALES@WASHERWERKS.COM

**FAST**

FAST QUOTATIONS & QUICK DELIVERY

QUALITY PRODUCERS OF WASHERS AND STAMPINGS

912 HIGH STREET  
MUNDELEIN, IL 60060  
FAX: (847) 566-8381

**ALL AMERICAN WASHER WERKS**

**(847)566-9091**

**DISTRIBUTOR NEWS**

**J.W. Winco Inc.** was awarded the 2012 APSE Best Employer Award for medium-sized companies.

Association for Persons in Supported Employment presents awards annually to the nation's top companies in customized employment – the integration of persons with disabilities into the workforce. Award recipients were selected out of thousands of U.S. organizations.

Wisconsin-based Winco is led by brothers Mark Winkler, CFO; CEO John Winkler; and CIO Robert Winkler. They share of office of president of the family-owned company.

"A company that employs a diverse workforce is better able to understand the demographics of the marketplace it serves, and is better equipped to thrive in that marketplace," Mark Winkler said in accepting the award. "As our father always said, 'Building a strong foundation of talented and hardworking employees supports a roof of success!'"

Winco works with Milwaukee-based Creative Employment Opportunities Inc., a private, for-profit employment agency that assists individuals with disabilities in obtaining and maintaining employment. Winco supplies fixture & fastening components, adjustable levers, cabinet U-handles, plastic and steel hinges and locking mechanisms, revolving and retractable handles, hand wheels, hand cranks, tube connection and conveyor components, inch and metric construction tubing, shock absorption mounts, leveling mounts, hand knobs, spring, ball and indexing plungers, jig, retaining magnet assemblies, toggle clamps, metric casters and wheels, universal joints, oil sight glasses, and metric tools for the industrial and commercial equipment industries.

For more information about J.W. Winco and this award, or any of their products, contact them at 2815 S. Calhoun Rd, New Berlin, WI 53151. Tel: 1-800-877-8351, Fax: 1-800-472-0670, email: sales@jwwinco.com or on the web at www.jwwinco.com.

**shear-Loc®** THE ORIGINAL INSTANT THUMBSCREW

WWW.SHEAR-LOC.COM

CALL ABOUT LASER ENGRAVING

FREE SAMPLES

4 STYLES INCH METRIC

CALL OVER 3000 COMBINATIONS

**800-775-5668** FAX 949-768-8705

AVAILABLE: IN COLORS, KITS AND A MULTITUDE OF THREAD OPTIONS

23191 PERALTA DR., LAGUNA HILLS, CA. 92653



### **Knapp Fasteners Incorporated**

520 Boxwood Drive Cambridge, Ontario N3E 0A6

Tel: 1-800-265-6609 Fax: 519-653-0294

Email: [info@knappfast.com](mailto:info@knappfast.com)

[www.knappfast.com](http://www.knappfast.com)

## YOUR GO-TO SOURCE FOR ALL FASTENERS

Knapp Fasteners is a leading supplier to the Aerospace, Military and Industrial markets with over 16 million fasteners in stock and over 60,000 different parts. Serving the North American and overseas markets for over 25 years, their commitment to providing superior quality, timely delivery and exceptional customer service is a promise that began over two decades ago and one they still honor today.

Knapp offers a large stock of Hex Serrated Flange Screws – ready to ship today with no minimum quantity. They are ISO 9001:2008 certified and registered with the Controlled Goods Directorate.

In January 2010, Knapp Fasteners moved into a brand new 25,000 square foot state of the art building

which is staffed by highly skilled, dedicated and experienced employees which all have one goal in mind – complete customer satisfaction. Knapp offers innovative, effective solutions for all of your fastener

needs and boast an extensive inventory available for immediate delivery. Knapp Fasteners is a large stocking distributor of Spaenaur parts.

Need a fastener, any fastener? You're at the right place. Knapp Fasteners offers every size, shape or material you require – standard or semi-standard, inch,

metric or custom. They supply all materials including steel, stainless steel, rubber, nylon, brass, aluminum, phenolic, titanium, silicon bronze and even special plating finishes. Virtually no orders are too big or too small. 



## Our Strength Is Quality

Knapp knows there's no room for error. We've served Industrial, Aerospace, and Military hardware needs across North America for 25 years. 60,000 fasteners of every description are our nuts and bolts with 16 million of them ready to ship from our warehouse. If it doesn't exist, we'll re-build it, custom plate it, or manufacture it. We're also firmly in place as Vendor Managed Inventory specialists for optimum supply chain performance and ISO 9001-2008 certified with the Controlled Goods Directorate (CGD).



### **Hex Serrated Flange Bolts**

Our specialty – Shipped from stock

**Count on Knapp Fasteners.**

# MWFA 31ST ANNUAL FASTENER SHOW MEDINAH BANQUETS, ADDISON, IL - JUNE 26, 2012





# DYSON®

Domestic Fasteners and Forgings Since 1884



See us at  
NIFS  
Booth  
#1021

## Domestic Bolt and Nut Assemblies In Stock for Quick Delivery!

**Exclusively For Fastener Distributors**

Choose from a variety of bolts and screw head shapes. Diameters from 1/2" to 8." Metric sizes starting at 20mm. Matching Nuts are available, including Dyson's Patented D-LOC® Locking Nut System.

Now stocking popular alloy and carbon grade bolts from 1-1/4" through 2-1/2" diameter.

The Dyson Corporation  
www.dysoncorp.com

Call us...  
**800-680-3600**

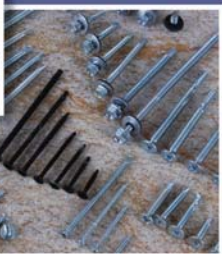
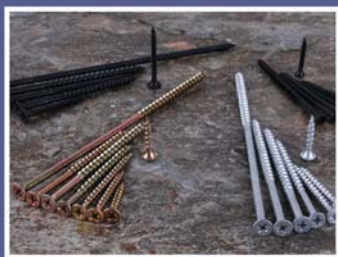

- Drywall Screws
- Self Drilling Screws
- Woodworking Screws
- Acoustical Fasteners
- Needle Point Self Piercing Screws



### CTG International LLC

140 Commerce Way  
Walnut, CA 91789  
Phone: (909) 598-9251  
1-877-CTG-INTL (284-4685)  
Fax: (909) 598-6042  
www.ctgintl.com  
Email: ctgintl@ctgintl.com



**RAPID DRIVE**  
Premier Industrial Fasteners

# Elgin Fastener Solutions

Get the right  
fastener solution  
for your application  
with the Elgin  
Fastener Group.  
ISO 9001:2008  
quality. Complete  
range of styles,  
sizes and finishes.

 The right  
fastener  
right now.™  
Elgin Fastener Group

Phone: 812-689-8917  
www.elginfasteners.com



**Ohio Rod Products**  
Versailles, Indiana

Custom manufacturer specializing in small diameter, long length headed and threaded fasteners through 9/6" long and 3/4" diameter. Superior straightness in plated parts. Tel. 812-689-6565



**Leland Powell Fasteners**  
Martin, Tennessee

Domestic quality manufacturing of small diameter fasteners and industrial machine screws (diameters from 4-40 to 1/2" and lengths to 5"). Includes Lo-Drive® and Grip-Lite™ screws and other standard, semi-standard and specialty fastener solutions. Tel. 731-587-3106



**Landreth Fastener**  
Martin, Tennessee

Leading manufacturer of cold headed solid, semi-tubular and brake rivets, with ISO certified quality systems and a focus on customer service. Tel. 731-587-3106



**Silo Fasteners**  
Versailles, Indiana

Leading manufacturer of lug bolts, form pins and round head fin neck bolts for the highway construction, concrete form construction and general distribution markets. Tel. 812-689-8905



**Chandler Products**  
Cleveland, Ohio

Leading manufacturer of cold headed fasteners (diameters from 3/16 to 3/4" and lengths to 9"), tight tolerances and multiple secondary operations for precision components used in heavy-duty diesel engines, transmissions & other demanding fastener applications. Tel. 216-481-4400



**Quality Bolt & Screw**  
Brecksville, Ohio

Manufacturer of custom engineered cold headed/cold formed bolts, pins, studs, chain, military & other custom fasteners. Tel. 440-717-7650



**Northern Wire, LLC**  
Merrill, Wisconsin

Custom wire forming, machining, welding, bending, and cold heading for agricultural equipment, lawn & garden, landscaping, construction, and recreational vehicles. Processes material ranging from .080" to .750" in diameter, in lengths from 1/2" up to 12 ft. cut from coil. Also offers plating and assembly options. Tel. 715-536-9551



**Best Metal Finishing**  
Osgood, Indiana

Specializes in electro deposited zinc and zinc phosphate coatings for fastener manufacturing, stamping, fabrication and metal forming industries. Tel. 812-689-9950



**Elgin Fasteners International**  
Versailles, Indiana

EFI provides extensive fastener engineering, offshore purchasing and quality capabilities. EFI is staffed by sales engineers and import professionals with considerable background in industrial fasteners. Tel. 812-689-6565

## DISTRIBUTOR NEWS

### Elgin Fastener Group

announces the completed acquisition of Northern Wire, LLC of Merrill, Wisconsin. Founded in 1970, Northern Wire has grown into one of the leading privately held wire forming companies in the United States.

Jeff Liter, EFG CEO, said, "The acquisition of Northern Wire gives the Elgin Fastener Group a solid foothold in the wire form market and opens new doors to product lines that were previously closed to us. We continue to add domestic manufacturing capabilities that expand our total range of specialty fastener options."

Northern Wire, LLC is an ISO 9001:2008 certified manufacturer with machining, cold heading, and welding capabilities in addition to wire forming. Northern Wire processes material ranging from .080" to .750" in diameter, up to 12 feet in length.

Elgin Fastener Group is comprised of seven leading domestic specialty fastener manufacturers (Ohio Rod Products, Leland Powell Fasteners, Chandler Products, Quality Bolt & Screw, Silo Fasteners, Landreth Fastener, Northern Wire, LLC), a metal finishing company (Best Metal Finishing), and an offshore sourcing and engineering division (Elgin Fasteners International).

Contact EFG at 812-689-8917 or visit their website at [www.elginfasteners.com](http://www.elginfasteners.com).

# ATLANTA ROD & MANUFACTURING COMPANY, INCORPORATED

(800) 633-6794 - [www.atlrod.com](http://www.atlrod.com)

## HOT-FORGED DOMESTIC & SPECIALTY NUTS

### HEADED BOLTS

### SOCKETS

1/2" - 2 3/4" DIAMETER

M12 - M68 DIAMETER



17-4 PH

A194 - ALL GRADES

A193 - ALL GRADES

A563 - ALL GRADES

DUPLEX 2205/2507

NITRONIC 50/60

MONEL K500/400

INCONEL 600/718



ATLANTA  
ROD &  
MANUFACTURING  
COMPANY, INCORPORATED



ISO  
9001

# UMETA

## OF AMERICA INC.

The complete lubrication equipment, fittings & accessories line.



Umeta is your source for over 1,400 grease fittings in standard or non-standard sizes, as well as custom-designed fittings according to your specifications. Fittings available in zinc plated industry grade steel, stainless steel, and brass. Made in Germany for over 75 years. OEM quality and ISO 9001 certified.

Toll Free: **800-595-5747**

147 Bluewing Lane • Mooresville, NC 28117  
Phone: 704-799-1840 • Fax: 704-799-1923  
e-mail: [umetausa@aol.com](mailto:umetausa@aol.com) • web: [www.umetausa.com](http://www.umetausa.com)

## Why Are You Saying NO To Assortment Sales?



### FAS-KIT<sup>®</sup>

#### ASSORTMENTS

- ☑ US Standard
- ☑ Metric
- ☑ Stainless Steel
- ☑ Automotive

Your Company  
Name Here!

Refill Packs  
Available

- Call or Fax for Catalog & Distributor Price List.
- Over 300 Assortments to Choose From.
- Large & Small Metal Trays.
- Open Bolt Bins & Plastic Boxes.
- Same Day Shipments.

Call: **1 800 44-SARJO**  
FAX: **845-454-0070**

FAS-KIT<sup>®</sup> is a registered trade mark of Sarjo Industries, Inc.



## DISTRIBUTOR NEWS

Sphere 1 named **Simpson Strong-Tie** as its 2011 Preferred Supplier Partner over 84 other preferred companies.

The award from the cooperative of independent tool and fastener distributors goes the organization ranking highest overall in six criteria, including sales volume increase over 2010, growth percentage, number of members purchasing from the supplier, completion of Gateway for Growth programs and Sphere 1 University course completions during 2011.

"Simpson Strong-Tie came on as a preferred supplier in the anchor and connector categories in 2008, at the cusp of the worst market meltdown since the Great Depression," Sphere 1 CEO Carol Shackelford said. "The company never gave up on our members and stayed steadfast in establishing strong partner bonds and growing our mutual business as conditions improved." Web: [sphere1.coop](http://sphere1.coop)

"Sphere 1's recognition of Simpson Strong-Tie as Preferred Supplier Partner of the Year is a great honor for our company and for all of our employees," Simpson Strong-Tie president Terry Kingsfather responded.

The Simpson family had been in the San Francisco Bay Area construction business in 1914,. In 1956 a neighbor of Barclay Simpson inquired about structural connectors for a flat roof, which led to development of Simpson Strong-Tie.

Simpson's 2011 sales totaled \$603.4 million. Simpson creates structural products for homes and buildings – helping structures resist high winds, hurricanes and seismic forces. Products include connectors, fasteners, fastening systems, lateral-force resisting systems, anchors in addition to products for concrete repair, strengthening and protection.

For more information about Simpson and their award, or their products, contact Simpson at 5956 W. Las Positas Blvd., Pleasanton, CA 94588. Tel: 925-560-9000 or 1-800-925-5099 or on the web at [www.strongtie.com](http://www.strongtie.com).

# Special Washers & Stampings



- 40,000 Different Special Washers In Stock
- Vast On-Premise Raw Material Inventory
- In-House Tool Room
- Modern CNC and EDM Machines
- Short Production Runs for Prototypes
- Special Sizes and Tolerances
- .062" to 12" O.D.'s in All Shapes and Sizes
- Sheet Materials from .002" to 1/2" Thick

Specials are standard at Willie Washer. You can find over 40,000 different special washers available for same day shipments from Willie's stock. If a special run is what you need, Willie gives you a head start on production with an in-house tool room that has the latest in CNC and EDM machines and a separate short-run division for prototypes and low volume needs. Cap it off with presses that can stamp materials thinner than a sheet of paper, or up to a 1/2" thick, and you'll find the source for your special needs. Look to Willie Washer for quality craftsmanship and flexible production capabilities to make the right size at the right price... right on time!



**WILLIE WASHER**  
MANUFACTURING CORPORATION

SPECIAL WASHERS AND STAMPINGS

MAKING THE BEST WASHERS SINCE 1972

847/956-1344 • FAX: 847/956-7943



### Advance Components

2920 Commodore Drive #100 Carrollton, TX 75007  
Tel: 972-446-5500 Fax: 972-323-3100  
Email: sales@advancecomponents.com  
www.advancecomponents.com

## ADVANCE COMPONENTS: STOCK, SERVICE, SUCCESS

For 40 years, Advance Components has been providing distributors with the best in specialty fasteners and customer service. Since 1972, the company has steadily increased its stock, its status and its warehouse square footage. Despite all that growth, Advance hasn't changed its motto: "Stock and service equal success for the customer."

It takes a team of thoroughly trained professionals to live up to the Advance motto, and no one knows that better than Advance's executive vice president and general manager, Gary Cravens.

"The Advance team has worked hard to make this one of our best years for the company and our customers," says Cravens.

"The economic downturn really opened our eyes to the value of our employees and how valuable they are to our customers. Today, we are very conscientious about what we put on our shelves. We only stock for the distributors in the industry, so our products are the best performers, our sales team is at the top of the class in product and engineering applications and our warehouse has quality control and shipping down to a science. You can't sail a successful ship without a great crew," says Cravens.

Advance helps its customers succeed by being a master-stocking distributor of ARaymond Tinnerman, AVK, Heyco and Johnson & Hoffman products. Advance is also a distributor of Richco, Captive, Spirol, Gripco POP and TRW Automotive fasteners.

The company's main office and warehouse are centrally based in Carrollton, Texas, just outside Dallas. Advance also has an office in Ohio headed by industry veteran Dave Audia.

"Having an office in Ohio is very advantageous as we have a strong customer base in this area," says Audia. "Whenever a customer or a potential customer has any engineering application questions or problems, I'm always available whether by phone or an office visit. Working on a tricky fastener application is my forte," says Audia.

Advance has updated its website with a contemporary design and a streamlined user experience.

Advancecomponents.com is now a true resource for distributors, offering its users:

- Detailed engineering specs and images to help customers find the right product for the job.
- An interactive map identifying Advance's sales territories and managers to help customers identify where to call for engineering questions and quotes.
- Current videos of the latest products and applications.
- A live twitter feed for product and industry news.

"Our new site offers more detailed product information and improved navigation, providing a much better experience for our new and returning customers," says Pam Berry, Advance's executive vice president/marketing "We have been working toward this goal for

months, and are very excited to launch our new website during our 40th year of business in the fastener industry," says Berry.

Advance Components is a master-stocking distributor for distributors in the fastener industry, which gives customers more options when ordering large amounts of fasteners from manufacturers such as ARaymond Tinnerman, AVK, Heyco, Johnson & Hoffman and more. ○



Above: The Advance Components team.

Below: Scan here to link to Advance's website



# LARGE & SPECIAL FASTENERS FAST!

- HUGE INVENTORY
- OFF THE SHELF AND QUICK
- JUST-IN-TIME DELIVERIES
- SAE OR ASTM SPECS
- STRATEGICALLY LOCATED  
WAREHOUSES NATIONWIDE
- YOUR REQUIREMENTS IN-STOCK  
SPECIALS OR STANDARDS
- DEPENDABLE AND TRACEABLE



#### CORPORATE OFFICE/MAIN WAREHOUSE

Box 2035, 2941 E. 10 Mile Road, Warren, Michigan 48090-2035  
586-757-4100 / 800-882-0747 • 586-757-1555 fax • sales@darlingbolt.com

#### HOUSTON WAREHOUSE

1915 Turning Basin Drive, Suite #506, Houston, Texas 77029  
713-673-3971 • 713-672-6642 fax

#### LOS ANGELES WAREHOUSE

11023 Forest Place, Santa Fe Springs, California 90670  
562-946-1458 • 562-946-3268 fax

**DARLING BOLT  
COMPANY**

*Since 1958*

**(800) 882-0747**

**www.darlingbolt.com**



## Anthony Di Maio

Anthony E. Di Maio attended Wentworth Institute and Northeastern University. In 1962 he started working with Blind Fasteners as Vice-President of Engineering & Manufacturing for two blind rivet manufacturers. He has been Chairman of the Technical Committee of the Industrial Fasteners Institute (IFI) and is still involved in the writing of IFI specifications. In 1991, he started ADM Engineering and is working with Fastener Manufacturers developing new fasteners and special machinery. He can be reached at ADM Engineering, 6 Hermon Ave., Haverhill, MA 01832; phone and fax 978-521-0277; e-mail: [tdimaio@verizon.net](mailto:tdimaio@verizon.net).

# BLIND RIVET SETTING TOOL MAINTENANCE

I receive many phone calls claiming that their blind rivets are not setting properly. After a few minutes of conversation with the user, I find that it is not a malfunction of the blind rivet, but it is the problem of the setting tool.

The following are 10 subjects that should be acted upon to maintain good steady blind rivet setting tool performance.

### 1. Clean Jaws

At least after 25 hours of setting blind rivets, the pulling jaws should be removed from the setting tool and cleaned and lubricated. If wear is visible on the gripping teeth of the jaws, the jaws should be replaced. The outer surface of the jaws should be lubricated each time the jaws are cleaned or replaced. When setting blind rivets that have a stainless steel mandrel, jaw wear is more rapid because of the hardness of the stainless steel. A pulling jaw service cycle of 25 hours is still adequate for jaw inspection.

The pulling jaws will cause flaking of the mandrel material when gripping the mandrel. These metal flakes will lodge themselves in the pulling grooves of the jaws and will prevent the jaw gripping grooves from penetrating the surface of the mandrel, thus, causing the jaws to slip on the mandrel and not set the blind rivet.

### 2. Tool Leaking Oil

Most setting tools are powered by compressed air and hydraulic oil. The compressed air pushes a piston and the rod of this piston is pushed into the hydraulic oil chamber. The oil is then pushed into a hydraulic piston section and this hydraulic piston pulls the setting jaws and sets the blind rivet.

Any loss of hydraulic oil will reduce the stroke of the setting tool and will not set the blind rivet in one stroke.

Hydraulic oil seals and o-rings should be checked if you have a loss of stroke or oil dripping from the setting tool. The seals and o-rings should be replaced.

### 3. Tool Needs Two Strokes To Set Blind Rivet

When the proper length blind rivet is used in the application and the setting tool is properly maintained, the blind rivet will set in one stroke, no matter which diameter blind rivet is being used.

The following are the reasons why the setting tool does not set the blind rivet in one stroke.

- (A) Dirty or worn pulling jaws.
- (B) Low air pressure. Air pressure must be what the tool manufacturer recommends.
- (C) Low air volume. Air/hydraulic setting tools should not be attached to small diameter air hoses.
- (D) Loss of hydraulic oil.



### 4. Service Setting Tool

When servicing pulling jaws, the setting tool should be inspected. It is the hydraulic oil pressure that pulls the pulling jaws and sets the blind rivet, but it is a compression spring that returns the stroke of the pulling jaws to open the jaws to release the spent mandrel and accept the next blind rivet. The "return spring" should be checked for length and condition. If the return spring is 5/16 of an inch shorter than a new compression spring, replace with a new compression spring. Also, be sure that all locking nuts are tight.

### 5. 2 or 3 Piece Jaws

Pulling jaws are constructed of either a set of 2 or 3 pieces. 2 piece jaws are usually used for setting tools that will set 3/32 to 3/16 diameter blind rivets. 3 piece jaws are used in setting tools that set 3/16 to 1/4 diameter blind rivets. Both the 2 and 3 piece jaws should be inspected after 25 hours of operation.



# Why Bet With Anyone Else, . . .



# When You Can Win With *Prestige!*

**Prestige  
Stamping,  
Inc.**

- ψ Fast Delivery
- ψ Competitive Pricing
- ψ Quality -  
    QS & ISO Certified
- ψ Reliable Service
- ψ Modern facility  
    105,000 sq.ft.
- ψ Finest Prime Material
- ψ Domestic  
    Manufacturers of:  
    Type 1 & Type 3  
    Structural washer to  
    ASTM F-436 Specs.
- ψ Through Hardened &  
    Standard S.A.E. &  
    U.S.S. Washer  
    marked with  
    Size Pattern
- ψ Belleville & Conical  
    Spring Washers
- ψ Special Flat &  
    Wave Washers
- ψ Pre-Assembly Sems  
    type Washer

23513 Groesbeck Hwy.  
P.O. Box 1086  
Warren, MI 48090  
Phone 586-773-2700  
Fax 586-773-2298  
[www.prestigestamping.com](http://www.prestigestamping.com)

MWFA - P. O. Box 5, Lake Zurich, IL 60047 • Tel: 847.438.8338 • 1.800.753.8338 • Email: mwfa@ameritech.net • www.mwfa.net

## MID-WEST FASTENER ASSOCIATION

### MWFA's 31st ANNUAL FASTENER SHOW & 60th GOLF OUTING HUGE SUCCESSES *continued from 14*

Matenaer Corp.	Prospect Fastener	The Stutz Company
Metal Resources	Quantum Storage	Titan Fastener Products
Metric & Multistandard	RAF Electronic Hardware	Tramec/Hill
Metric Fasteners Corp.	Rare Earth Solutions	Trinity Hardware
Mid-West Fastener Association	Rite-Pack LLC	TriStar Metals
Modform	Riverdale Plating & Heat Treating LLC	USA Fastener Group
Morgan Ohare	Rockford Secondaries	Valley Fastener Group
National Threaded Fasteners	Rogers Brothers Galvanizing	Vertex Distribution
NBS Corp.	Rotor Clip Company	Volt Plastics
ND Industries	Screws Industries	WIFI, Inc. (Women in the Fastener Industry)
Ningbo Jinding Fastening Piece	Sems & Specials	Willie Washer Mfg.
Nucor Fastener Division	Solution Industries	Wrought Washer Mfg. Inc.
Nylok LLC	South Holland Metal Finishing	XL Screw Corp.
OSR Inc.	Star Stainless Screw Co.	Yellow Woods
Paulin Industries	Stelfast Inc.	
Porteous Fastener Company	SWD Inc.	
Praxair Surface Technologies	The Dyson Corp.	

#### Comments Received Included:

*"Thanks, and congratulations on putting together an excellent show. I believe this was the best tabletop we've participated in for several years, and the facility was excellent."*

*"Excellent job and you are to be commended. Nice facility and despite the slow golf...only complaint I could imagine you might hear, everything else was perfect."*

*"I received so many new leads at this show, it was great!"*

*"I wanted to congratulate you on the great success of the 31st Annual Fastener Expo held this week in Addison. Both exhibitor and "customer" traffic was great; you wouldn't know that the economy was underperforming based on the overall attendance. Further, most comments I heard were very favorable regarding current and near-future sales and production volumes. Some of this can be accounted for by a major re-shoring effort in the fastener industry, some is inventory rebuilding, and some is pent-up demand. Any way it comes, we'll take it!"*

*"The table top show was just awesome. Great attendance, good venue and lots of networking and mingling."*

Nancy Rich reports the enthusiasm at the show and golf events was greater than she'd seen in a long time. Shows became more of a challenge as the industry faced economic issues but the MWFA adjusted to still provide exhibitors and visitors with beneficial business opportunities. The history of economics doesn't allow every show to get better than the last but it does allow a value opportunity every time. "Many long time exhibitors

have expressed their support of shows as it's an opportunity for face to face with many industry people for a small fee per meeting." It was great to see the industry enjoy two days of great events, opportunities, networking and appreciation for what the MWFA provided them.

Next year the MWFA will feature Fastener Tech '13 cosponsored by Fastener Technology International and contributors to events in conjunction with the show. SUR/FIN '13 will once again co-locate their show with Fastener Tech creating a multiple show, one stop event.

*Note: Exhibitors have begun to register for Fastener Tech '13. Be sure to visit websites where you can find info & register at [www.fastenertech.com](http://www.fastenertech.com) and [www.mwfa.net](http://www.mwfa.net).*

*Exhibit questions may be directed by email to Nancy Rich at: [mwfa@ameritech.net](mailto:mwfa@ameritech.net) or Tom Hutchinson at: [tlh@fastenertech.com](mailto:tlh@fastenertech.com).*

#### Dual Golf Outings with This Year's MWFA Fastener Show

Some brave contenders participated in glow golf after the Fastener Bash which turned out to be a great fun as they golfed their way through four holes in the dark. The next day brought over 180 golfers out for an all day event with 7:30 a.m. and 1:00 p.m. shot gun starts which featured Brian Walker, "hot shot" golfer who demonstrated his driving talents during lunch and shared golf swing advice, at one of the holes, with everyone. The golf outing winning teams were: Glow Golf-Dan Duffield (Detroit Washers & Specials), Andy Hayman (Aztech Locknut Co.), and John Butler (K&L Sales).

*please turn to page 130*



### Leland Industries Inc.

95 Commander Blvd., Toronto, ON M1S 3S9, Canada  
 Tel: 416-291-5308 Toll-Free: 1-800-263-3393 Fax: 416-291-0305  
 Email: [info@lelandindustries.com](mailto:info@lelandindustries.com)  
[www.lelandindustries.com](http://www.lelandindustries.com)

## LELAND INDUSTRIES IS EXPANDING!

Leland Industries Inc., a leading domestic manufacturer of fasteners for Agricultural Storage, Metal Building and industry, recently announced the acquisition of "Canadian Threadall Limited", located in Waterloo, Ontario. The addition of Threadall's manufacturing capabilities enhances Leland's commitment to the expansion of their domestic product offering to new and existing markets, in addition to custom bending and threading, Studs, U-Bolts, J-Bolts, Eye Bolts, threaded rod and miscellaneous specialty fasteners to its product offering. The purchase also includes CNC and EDM machining and other specialized machining equipment.

Canadian Threadall continues to operate separately to Leland Industries allowing both companies to collaborate on special projects, while enjoying the opportunities afforded by shared inventories.



Leland Industries, (est.1984), also purchased the production equipment from the former "Westland Steel Products Ltd." of Winnipeg, Manitoba, earlier in 2012. The production capabilities gained from this purchase included an increased bolt making ability up to 3/4" x 6".

Leland Industries has experienced continuous growth since incorporation. Currently the company operates from a wholly-owned 155,000 sq. ft. facility in a suburb of Toronto, Ontario servicing North America, Europe and the Near-East.

Leland has for many years dominated the "Grain Storage Market", being sole-sourced by many large corporations serving this industry. Leland does not import; it supplies its clients with bolts, nuts and screws manufactured using only North American steel and labor and plated with their exclusive "JS1000." 

# Fastener Synergy

Now, with the acquisition of Canadian Threadall, an independent Canadian manufacturer, custom bending, threading, studs, U-Bolts, J-Bolts, Eye-Bolts, threaded rod and other specialty fasteners are added to the product mix.

The synergy allows both companies to collaborate on special projects, and take advantage of shared inventories.

Leland has also purchased the production equipment from Westland Steel Products of Winnipeg – giving us increased capabilities, including bolt making up to 3/4" x 6".

All product is North American made! And made to last – thanks to our exclusive long-life JS1000 plating!



[www.threadall.com](http://www.threadall.com)  
 1-877-777-2612



[www.lelandindustries.com](http://www.lelandindustries.com)  
 1-800-263-3393



### Cardinal Fastener Inc.

5185 Richmond Road, Cleveland, OH 44146  
 Tel: 1-800-237-3477 Fax: 216-831-3651  
 Email: sales@cardinalfastener.com  
 www.cardinalfastener.com

## CARDINAL'S WINNING COMBINATION

by Grace Wehner

What a difference a year makes. When you look at Cardinal Fastener today, you see smiling faces and levels of enthusiasm like only those seen at the London Olympics. On a recent visit to the company, it was reassuring to see the same people that have been there for so many years – many with different titles. According to John Grabner, (still President), “The growth we have been experiencing has necessitated the need to hire some great people and promote others.” The changes in the sales area alone include Danielle Taylor who is now Inside Sales Manager, Cristy Muha has added Certified Fastener Specialist to her Inside Sales title, and Ann Brady is back from maternity leave. Other recently hired sales people include Holly Flauto, Inside Sales, Mylon McConoughey, Key Account Manager, and Dennis Cote, Southern Regional Sales Manager. Another indication of Cardinal’s growth is that they have doubled the size of their booth in Las Vegas, and if you stop by, you will see it staffed with many sales people.

I asked John Grabner what he attributed the growth to and without hesitation he responded, “Cardinal has always been known for great quality product and responding to customers quickly with fast lead times. Combine this with lower prices and an expanded product line, we are really meeting the customer needs on all fronts.” Apparently, Cardinal has found a way to lower its costs and prices by purchasing material directly from the steel mills (remember, Cardinal is 100% domestic

manufactured product), and investing in new equipment to improve efficiency.

When I spoke with Danielle Taylor, she echoed the increase in business but offered another aspect, “We have become very competitive on all levels, including large volumes, and we are also quoting these larger inquiries full freight allowed. We have negotiated really low freight rates and are passing these savings along to our customers.”

When you walk through the 90,000 square foot facility, things are humming and people are busy. Apparently the IFI (Industrial Fasteners Institute) liked what they saw because after scheduling a tour for their 23 Fastener Training Seminar attendees in July, they reported the following highlights:

- The operators at Cardinal explaining the process – intelligent work force
- Speakers and tour at Cardinal
- Cardinal Fastener – enjoyed seeing the bigger fasteners hot forged

In conclusion, I would suggest a call or a visit to the same Cardinal Fastener that has been in business for almost 30 years but with new improvements. It is nice to see companies in our industry buying new equipment and adding people to keep up with the growing demand. As Wendy Brugmann, Chief Operating officer said, “Our philosophy is build it and they will come. So we continue to build a great company.” 



**QUALITY**  
HIGHEST LEVEL



the  
**cardinal**  
**PRICE**  
is  
**Right**

**SERVICE**  
SUPERIOR

**DOMESTIC**  
COMPETITIVE

WHEN IT'S CRITICAL... IT'S CARDINAL.

**VISIT US AT**  
**BOOTH 1223**

At The Fastener & Mill Supply Expo in Las Vegas  
October 11-12, 2012

Cardinal Fastener Inc. is the largest manufacturer of hot forged fasteners in North America. The product line ranges from ½" to 3" diameter, or M20 to M72.

**CARDINAL FASTENER INC.**  
5185 Richmond Road  
Cleveland, Ohio 44146  
800.237.3477  
cardinalfastener.com



# QUALITY CONTROLLED CRAFTSMANSHIP



**ISO9001:2008 CERTIFIED**



**R&R Engineering Company Inc**  
PO Box 428, Summitville, Indiana 46070  
phone 800.979.1921 • 765.536.2331  
fax 800.345.9583 • 765.358.3957  
email sales@randengineering.com  
web www.randengineering.com



## DISTRIBUTOR NEWS

The **Quick Cable Corporation**, the DC power experts announced the release of the new Golf Cart Accessory Catalog featuring the Quick™ brand of golf cart battery cables. The new catalog contains 40 pages of the highest quality golf cart battery components such as pre-made cables, connectors, wire & cable, spill kits, chemicals, tools and hold downs.



The new catalog is a natural progression for Quick Cable. All golf carts need batteries to run and electric golf carts run solely on battery power "Golf cart batteries are subjected to extreme conditions day-in and day-out. Bringing a comprehensive offering to protect that investment was our goal and we think we've succeeded in doing that." Said Bob Hoganson, President of Quick Cable Corporation.

You can view the new Quick Cable Golf Cart Accessory Catalog online by visiting [www.quickcable.com](http://www.quickcable.com) or request your own copy by calling customer service at 1-800-558-8667.

## DISTRIBUTOR NEWS

**Hawk Fastener Services LLC** would like to announce the purchase of a 28,000sf. warehouse in Alsip, Illinois. The larger facility will help us to more efficiently meet the expectations and requirements of our customers and will be fully operational on August 1, 2012.

Established in 1997, Hawk Fastener Services LLC is a distributor of bonded sealing washers, roof pipe flashing, brass

threaded insert plugs and self drilling screws with or without bonded sealing washers attached. Automated assembly of many different types of fasteners with bonded sealing washers and powder coating of the screw head and bonded washer is available in-house

Contact: Hawk at Tel: 708-599-9947, Fax: 708-599-9943, Email: [thehawk1@ameritech.net](mailto:thehawk1@ameritech.net) or go to [www.hawkfastservices.com](http://www.hawkfastservices.com).



### **Beta Steel Group**

PO Box 189002, 44225 Utica Road, Utica, MI 48317

Tel: 1-800-594-9074 Fax: 586-323-6806

Email: [sales@betasteel.com](mailto:sales@betasteel.com)

[www.betasteel.com](http://www.betasteel.com)

## **BETA STEEL: CUSTOMER SERVICE SPECIALISTS**

Understanding our customer, this is a must in Beta Steel's dedication to providing superior customer service. We take the extra steps that are needed to be a more complete supplier. Our belief is that pro-active thinking and assisting our customer beyond the supply of steel rod and wire products will build the foundation for a successful partnership.

Attention to detail is also an essential piece of the superior service we provide. Every customer has different needs, we work hand-in-hand with our customers to develop supply and stocking programs that exceed expectation and adhere to the most demanding product requirements.

The service we provide goes well beyond that of our competition. Our job is not finished until product has

been produced from our material and our customer is 100% satisfied. To achieve this satisfaction, we are always working on innovative means and processes that will keep us in the forefront of the steel rod and wire industry.

With the widest variety of steel inventory in the industry and 300,000 square feet of warehousing space, Beta Steel provides quick response to the most demanding steel requirements.

Our knowledge of the steel wire industry matched with our processing capabilities, give us a combination that customers have relied on for over 40 years.

Please visit us at [www.betasteel.com](http://www.betasteel.com) for more information as to how Beta Steel can be your premier steel rod and wire supplier. 



## **Beta Steel provides logistics to meet every steel need**

When it comes to delivering quality steel wire products, Beta Steel employs logistics that get the job done. Our use of proprietary trucking allows us the flexibility and speed to satisfy customer needs regardless of load weight or product combination.

Please visit us at the  
National Industrial Fastener & Mill Supply Expo  
Booth # 945  
October 10 - 12, 2012  
Sands Expo & Convention Center, Las Vegas, NV



To get a better idea of how Beta Steel's speed can work for you, scan the QR code or visit [betasteel.com](http://betasteel.com)



**AGILITY SPEED STRENGTH**  
The Beta Steel Experience

## NATIONAL FASTENERS DISTRIBUTORS ASSOCIATION

# NFDA STRATEGY SESSION: HILTON SCOTTSDALE RESORT, NOV 7-8, 2012

## *Be Part of our Future*

There are exciting times ahead for NFDA, and we want you to be involved in shaping our direction.

To get there, we are changing things up for our 2012 Fall Meeting. Instead of what we traditionally offer, we are going to spend the time this fall focusing on the future of our association.

At the 2012 Spring Meeting in Georgia we announced the strategic initiatives for our association:

1. The NFDA brings leaders of the fastener industry together;
2. The NFDA provides tools and insights to owners / executives to increase the profitability of their businesses;
3. The NFDA will work with other fastener associations to strengthen the our industry;
4. The NFDA will serve as a national voice in policy matters that impact our members.

## *How do we get there?*

Only with your guidance, advice, experience and ideas. As we discussed, we want our members to define our organization and our future.

Here is the plan. We would like you to volunteer to work with other NFDA members to develop paths to achieve each of these four strategic initiatives.

You will get together with each other in virtual meetings before November (web meetings, conference calls, collaborative sites – whatever works for you). Then, we need you to bring your ideas to Scottsdale this November where, together we will finalize a roadmap for NFDA.

No speakers, maybe some badges, for sure lots of great ideas. It will not be all work. We have reserved time for poolside fun, golf, and a reception with members of the Pacific-West Fastener Association, who will be meeting at a nearby hotel after. Our goal is to better get to know each other as well as members of the

Pacific-West Fastener Association.

Speaking of Pac-West, NFDA members are invited to attend that association's fall conference, which takes place November 8-10 at the nearby Scottsdale Resort and Conference Center. Pac-West has generously offered the member discount registration fee to NFDA members. Registration details are at [www.nfda-fastener.org](http://www.nfda-fastener.org).

If you are ready to roll up your sleeves and help us make NFDA stronger, please contact us with your ideas. Call 877-487-6332 or 714-484-7858, or email [info@nfda-fastener.org](mailto:info@nfda-fastener.org).

We already are making plans for our 2013 Spring Meeting, which will bring back our usual format of education, recreation and networking. As of press time, tentative dates are February 19-21 in Florida. 

## *Fall Meeting Schedule*

### **Tuesday, November 6**

NFDA Board of Directors Meeting

2:00pm – 6:00pm

### **Wednesday, November 7**

Task Force Meetings

9:00am – 11:00am

Lunch

11:30am – 12:30pm

Strategy Session

1:00pm – 6:00pm

Evening Dinner

### **Thursday, November 8**

Morning Optional Golf

Morning Optional Tour/Activity

NFDA Social Activities

3:00 – 5:00 p.m

Evening Reception with Pac-West





**STOCK PRODUCTS**  
EYE BOLTS  
TURNBUCKLES  
SHACKLES/HOOKS  
CHAIN HARDWARE  
STAINLESS STEEL

**SPECIAL SERVICES**  
MACHINING:  
THREADING/DRILLING/TAPPING  
PRODUCT MODIFICATION  
EYE BOLT SPECIALS  
FINISHES:  
PLATING/GALVANIZING/BLACK OXIDE



**L I N K I N G**  
GLOBAL SOURCING WITH DOMESTIC STANDARDS  
A UNIQUE COMBINATION

7150 W. ROOSEVELT ST. SUITE C 101 PHOENIX ARIZONA 85043

PHONE: 1.888.936.1466



WWW.AZLIFTINGHARDWARE.COM



FAX: 623.936.8909



**Copper State Bolt & Nut Co. Inc.**  
 3637 N. 34th Ave Phoenix, AZ 85017  
 Tel: 1-800-528-4255 Fax: 602-272-3316  
 www.copperstate.com



## COPPER STATE CELEBRATES 40 YEARS!

On May 1st 2012 Copper State Bolt & Nut Co. Inc. (CSBN) celebrated its 40th year in business. From the onset Martin Calfee outlined basic principles which would help steer the company through both economic as well as business challenges. Martin and his team at CSBN committed themselves to being the finest manufacturer and distributor of fasteners and related products in North America. Over the years Martin's focus on being the best has not waived while his saying, "If you do business today like you did yesterday, you will not be around tomorrow" has become somewhat of a mantra with many of his lean and quality focused managers. Their focus on the future is for continuous improvement.

CSBN is an \$85 million supplier of fasteners, industrial and construction supplies, tools and tool repair, cutting tools and abrasives, and fluid sealing products. With almost 450 people on its team, CSBN is comprised of 21 distribution locations in Arizona, Texas, Colorado, New Mexico, and Nevada, and a Manufacturing Division located adjacent to the corporate headquarters in Phoenix, Arizona. In addition to CSBN's own distribution centers, the Manufacturing Division supports additional fasteners distributors throughout North, Central, and South America. CSBN prides itself in developing talented employees, carrying inventory to support customer needs, providing quality products and services, and in being an active and environmentally conscious participant in each community in which they are located.

CSBN Manufacturing supports more than 1,500 distributors and distance is not a problem for CSBN customers. Sixty percent of our domestically manufactured product makes its way east of the Mississippi River. CSBN's 40 years of experience as a fastener distributor has been a key in developing their Manufacturing Division's processes and services which

are specifically designed to support distributors in the industry. Supporting over 1,500 distributors has also provided extensive experience throughout many industries, such as Steel Fabrication, Mining and Aggregate, Construction, Heavy Equipment, Renewable Energy, Fluid Sealing, Scrap Metal, and more. Customers can capitalize on CSBN's experience to fulfill the types of products and service required.



Martin Calfee, Chairman/CEO

The types of products CSBN Manufacturing produces are basically hot-headed specials. While most of the products are viewed by distributors as "specials", the users of these products view them as critical components. The difficulty of the specials industry is in the repeatability of processing products; CSBN's answer to this problem is Critical Care Processing and Critical Care Products. Tight process controls, lean manufacturing, FMEA, PPAP, and an in-

house A2LA Accredited lab are integral parts of this critical processing. Improving this further, the scope of their lab is not only for destructive testing, but also for the in-process dimensional inspections required for consistency and reliable inspection frequencies.

To be "the best" with both users and distributors CSBN has focused on Service to the customer and Quality of its products. The management and employees of CSBN are committed to meeting or exceeding customer expectations. Much training and education are needed to optimize performance in these areas as challenges are forever developing. Communication throughout the organization is the key to promote an atmosphere of continuous improvement. CSBN has done much to improve the past 40 years with the effort of "being the best". CSBN's efforts will always be ongoing as Martin Calfee will remind everyone, "it is the customer who determines who is best." 



# 40<sup>th</sup> Anniversary

1972-2012



## Domestic Critical **Care** Fasteners



**ANSI/DIN/ISO**

- 1/2" thru 4-1/2"
- 16mm thru 115mm

Manufacturing Division  
**800-528-4255**

**Large Diameter or Long Length Standards  
and Made to Print Specials**

# New!



## Now Stocking Coil Inserts

- UNC: 2-56 to 1-1/2-6
- UNF: 4-48 to 1-1/2-12
- Metric Coarse: M2 to M39
- Metric Fine: M8 to M24
- Spark Plug: M10 to M18
- STI Taps and Drills
- Kits and Assortments

**EZLOK**  
 (800) 234-5613 • www.ezlok.com

**ACROSS**

1. \_\_\_ screws; fasteners that lay flat and resist corrosion
5. Main body of a screw
10. Surface depressions
14. "...but if it \_\_\_, I would appeal to God..." (Job 5:8)
15. Stated again
17. "What \_\_\_?"; words of pity
20. With 65 Across, place to use finishing nails
23. Breather's need
24. Go downhill fast
25. Tenant
26. More wily
28. Co. that merged to form Verizon
29. Dog show presenter: abbr.
31. Wound soother
34. One \_\_\_ million
35. Thought
36. Nos. expert
39. Blessed Padre \_\_\_; saint canonized in 1982
40. Hasidic celebration
41. What should be fastened with a dowel screw
48. "\_\_\_ say more?"
49. '68 Best Picture Oscar winner
50. Respond to a stimulus
54. Prohibitionists
55. Angry looks
58. One \_\_\_ time
60. Aquatic mammal
61. Scourer's need
62. Klutz
63. Long time
65. See 20 Across
67. Truncated cone point of a screw
70. \_\_\_ wrong word; misspoke
72. Water skier's line
75. Sale tag words
77. Gangster's gun
78. Word with about or fly
81. "There was an old woman who lived in \_\_\_..."
82. Continent: abbr.
84. Canned heat
86. Alfalfa bundle
87. Large rodent
88. Irish province
90. Actor Alexander

91. What should be fastened with a tack
97. Thickness of material secured by a fastener
100. Abbr. in a business name
101. Nav. rank
102. Company
103. \_\_\_ favor
104. Sleeve anchor head style
106. Sinatra's second
107. Curve in a fastener side
110. Crush
112. Disturbs
117. \_\_\_ bolts
119. Have debts
120. What one might do with brads
125. Nerve coil
126. Ice cream treat
127. Cozy homes
128. Old insecticides
129. Sweet hot cereal
130. Fem. titles

**DOWN**

1. Name on a tractor
2. Miscalculate
3. So-so grades
4. "Painter of Light"
5. \_\_\_ Lanka
6. Sermon topic
7. 1975 Wimbledon champ
8. Dundee denials
9. Optima and Spectra
10. Family members
11. Suffix for self or fool
12. Far things pointed to
13. Paul, before his conversion
14. Tiny amount
16. Monograms for Ike and others
18. Mid-11th century year
19. Actress Barbara's kin
20. Comedian
21. South Carolina city
22. New Orleans, San Diego, or Charleston
27. Cheerleader's yell
30. Despicable fellow
32. Full deck
33. Otto \_\_\_ Bismarck
35. No. of film dalmatians
36. Raised flanges on the heads or shanks of fasteners
37. Self-assurance
38. Part of speech: abbr.
40. Large, biting fly
41. Shank extremities
42. Infamous emperor
43. Actress Susan's family
44. Patriots' goals, for short
45. Word of amazement
46. Casual wear
47. Engagement
51. Greek capital: abbr.
52. Corp. head
53. Credit record agcy.
55. Ivory, for one
56. "...along \_\_\_ spider and sat down..."
57. Mistaken
59. "...It is a nipping \_\_\_ eager air..." ("Hamlet")
64. Ejections
66. Mr. Preminger
67. Appear unexpectedly
68. Turn soil
69. Viscount's superiors
71. Actor Robinson's monogram
72. Tic-Toe connection
73. Barcelona bear
74. For what reason?
76. Five and five \_\_\_
78. Sudden breath
79. Lotion ingredient
80. Fender blemish
83. Support about which a lever turns
85. Suffix for cream or crock
86. Milled from the \_\_\_
89. Sault \_\_\_ Marie
90. \_\_\_ nuts
92. Here, in Latin
93. Beatle wife
94. One \_\_\_ kind
95. Small solid \_\_\_
96. Gift for a child
97. Family docs
98. Word with nose or numeral
99. Furious
104. "\_\_\_ Day's Night"
105. Charitable assns.
107. J- and U- followers
108. Night birds
109. Parker or Montgomery
111. Projection weld \_\_\_
113. Tenement area
114. Author Ferber
115. Neat
116. Cold spell
118. Pitcher
121. Portable bed
122. Schwarzkopf's monogram
123. Metro or Prizm
124. Light \_\_\_ feather

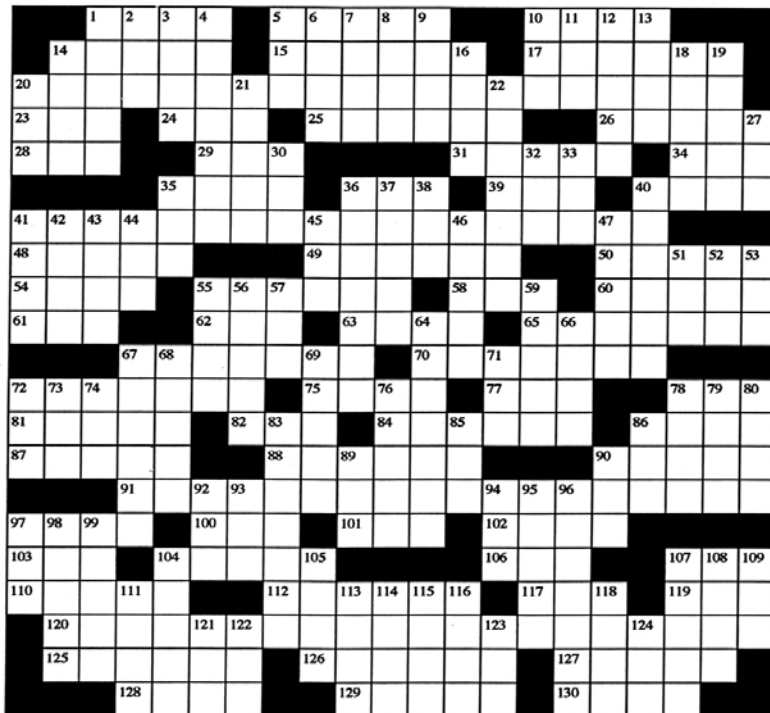

Solution  
 on  
 Page 251

**FASTENER CROSSWORD PUZZLE**

**"Quality is our key to success."**



**ISO 9001:2008  
CERTIFIED**

- Fast Shipment
- Eye Bolts, S Hooks, U Bolts and more...
- A Variety of Finishes Available
- Custom Manufactured to Meet Your Needs

**ANDROCK™**

Toll Free **800/397-2658**

**Androck Hardware Corporation**  
711 Nineteenth Street • Rockford, IL 61104 USA  
815/229-1144 • Fax 815/229-1895

USA

[www.androckhardware.com](http://www.androckhardware.com)



**COMPONENT PACKAGING**  
*Whatever It Takes!*

DISTRIBUTORS  
#1 CHOICE FOR  
PACKAGING &  
KITTING

**WE ARE PASSIONATE ABOUT PACKAGING...IT'S WHAT WE DO!**  
*Our customers make us who we are and that's what drives us to perfection.*



AUTOMATED KITTING • HAND PACKAGING • FASTENER ASSEMBLY • LARGER PART KITTING/BOXING

7931 East 24th St, Joplin, MO 64804 **tel** 417-624-9395 **fax** 417-624-2303 **email** [lorim@componentpackaging.com](mailto:lorim@componentpackaging.com) **web** [www.componentpackaging.com](http://www.componentpackaging.com)

Manufacturing  
Quick Bind Hardware, Decorative Screw Covers  
and **MUCH** more for the last 30 years!



Other products we offer include:

Miniature Plastic Fittings	Barbed In-Line Filters
Extruded Flexible Tubing	Multiple Fittings Kits
Barbed Check Valves	Protection Accessories
Quick Disconnect Luers	Try Our Free Samples



165 Industry Lane • Flippin, Arkansas 72634  
Phone 870.453.2343 • Fax 870.568.0811  
[www.ark-plas.com](http://www.ark-plas.com)

## DISTRIBUTOR NEWS

**Precision Specialties, LLC** headquartered in Collierville, TN announces the appointment of Matt Wallace to the position of Operations Manager.

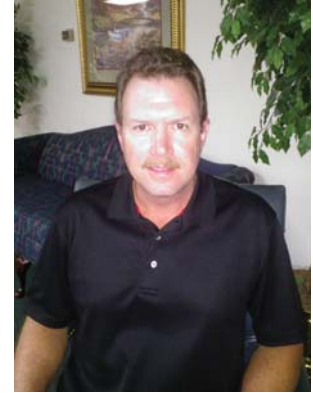

Matt has 30 years of experience in the fastener industry including positions in sales and procurement, most recently with Supply Technologies, in Memphis. Matt brings a new level of energy and industry experience to Precision Specialties and will facilitate our future growth, says Roger Szafranski, President of Precision Specialties.

Precision Specialties is ISO 9001 certified and is a master distributor for specialty fasteners from manufacturers such as AVK, Tinnerman, Oetiker, Rotor Clip and for critical components such as spring washers, belleville washers, lock washers, and grease fittings.

*When "Quality and Service Matter" contact Precision Specialties. You can reach them at 901-854-5640 or visit their website at [www.precspec.com](http://www.precspec.com).*

## DISTRIBUTOR NEWS

**Southern Fasteners & Supply Inc.** was named one of "25 North Carolina companies to Watch." Southeast-based entrepreneurial support organization CED chooses winners based on growth-oriented, second-stage companies that demonstrate performance, and innovative products.

The 25 recipient companies collectively added 936 jobs at an annual rate of 35% between 2008

and 2011, and grew revenue by an annual rate of 41% during the same period, totaling \$191 million in revenue.

Founded in 1982, Southern Fasteners is a minority-owned distributor with 60,000 items in inventory for MRO and OEM customers.

Contact Southern Fasteners at 1-800-642-0921 or on the web at [www.southernfasteners.com](http://www.southernfasteners.com).

# FILLS GAPS

But only between fastener threads.

**Expand-A-Seal ES0105<sup>®</sup>**, a unique, microencapsulated, thread sealing and locking compound, increases in volume 20 to 50% upon installation. It penetrates the gaps in fastener threads left unfilled by conventional threadlockers.

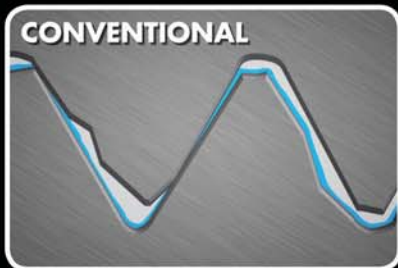

Fastener variation can create gaps (shown in white) between mating surface threads. Conventional threadlockers (blue area) are thin and insufficient at filling these spaces.

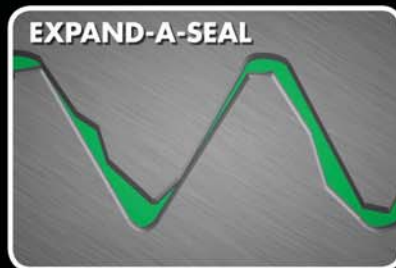

Expand-A-Seal (green area) expands 20 to 50%, completely filling the gaps between fastener threads, resulting in a strong lock and high-pressure seal.

#### ADDITIONAL PRODUCT BENEFITS:

- Low prevailing on-torque.
- Exceptional break-away torque.
- High-pressure seal.
- Fixes in minutes. Cures in 24 hours.
- Coated fastener shelf life up to one year.
- Replaces locking and sealing washers.

Contact us for free product samples.

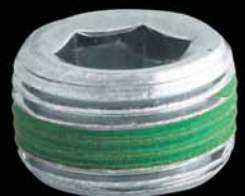

ND Industries, Inc., MI, USA • Phone: 248-655-2503  
www.ndindustries.com • products@ndindustries.com  
ND Processing Facilities: New Jersey • North Carolina • Ohio  
Michigan • Illinois • Texas • California • China • Taiwan

MWFA - P. O. Box 5, Lake Zurich, IL 60047 • Tel: 847.438.8338 • 1.800.753.8338 • Email: mwfa@ameritech.net • www.mwfa.net

## MID-WEST FASTENER ASSOCIATION

### MWFA's 31st ANNUAL FASTENER SHOW & 60th GOLF OUTING HUGE SUCCESSES *continued from 116*

We thank the many companies who donated bucket raffle and silent auction items. Thank you to our Premium Sponsors: All American Systems (Putting Contest), Star Stainless Screw (Lunch), Set Screw (Hot Shot Pro & Golf Balls), Screws Industries (Golf Balls), Brighton-Best Int'l and Nylok (Cocktail Hour), Solution Industries (Special Awards).

#### ***Thank you also to our many course contest sponsors:***

American Fasteners & Components  
Delta Secondary  
Aztech Locknut  
Big Bolt  
Industrial Fasteners Institute  
J&M Plating  
Solution Industries  
Beacon Fasteners & Components  
Set Screw  
Bella Design Group  
Brighton-Best Int'l  
Morgan Ohare  
Screws Industries  
Darling Bolt  
Rosemont Convention  
SWD Inc.

#### ***Tee/Green Sponsors***

Chun Yu Works Ltd  
B&D Cold Heading Inc.  
Continental-Aero  
Brighton Best Int'l  
Distributor's Link Magazine  
Wing-Hamlin Co. Inc.  
Ford Fastener  
Fastenersclearinghouse.com  
Matenaer Corp.  
Kanebridge Corp.  
Nucor Fasteners  
LEP Special Fasteners  
Porteous Fastener  
Riverdale Heat Treating & Plating LLC  
Vertex Distribution  
Abbott-Interfast Corp.  
Elgin Fastener Group  
South Holland Metal Finishing  
E Z Sockets  
Fall River Mfg.

Solon Wire Processing  
Sems & Specials Inc.  
Tramec/Hill  
XL Screw Corp.  
Rosemont Expo  
Allstar Fasteners  
Stelfast  
World Washer Mfg.

Eaglewood Golf Resort provided a great venue for the golf outing and dinner and we were fortunate with great temperatures before the 100 degree heat wave hit Chicago! Since the resort hosted the prior days Fastener Bash, Glow Golf and the 60th Golf Outing events, it was especially convenient for out of town guests.

A special thanks also to the Golf Committee, Rich Cavoto (chairman)-Metric and Multistandard Components, Bob Baer-Abbott Interfast, Brian Christianson-South Holland Metal Finishing, Matt Delawder-SWD Inc., Bob O'Brien-Certified Products, Bill Vodicka-Allstar Fasteners and Wayne Wishnew-XL Screw Corp. spent many hours planning and bringing to fruition this outing. We thank them for their hard work.

#### ***MWFA Welcomes New Members***

Accurate Drilling & Manufacturing-Elk Grove Village, IL  
Anderson Manufacturing Co. Inc.-Bristol, WI  
B&D Cold Heading Inc.-Taylor, MI  
Borg & Beck-Sterling Heights, MI  
Chun Yu Works Ltd-Geneva, IL  
ICS Flange-Huntley, IL  
Industrial Steel & Wire-Chicago, IL  
Lucky 13 Sales Inc.,-Elk Grove Village, IL  
Paulin Industries, Inc.-Parma, OH  
The Dyson Corp.-Painesville, OH  
Twin Fasteners and Supply Inc.-Bensenville, IL  
Trinity Logistics Corp.-Davenport, IA  
Varvit USA, LLC-Aurora, IL  
Velocity Energy-Naperville, IL

#### ***Upcoming Events***

October 20th	Plating Heat Treating Seminar Addison, IL
November 8th	Scholarship Awards, Elections Dinner Meeting with Guest Speaker Roe Conn, Radio Celebrity
December 13th	Holiday Party-Medinah Banquets Addison, IL 



# Specialty Steel & Metal Processing for Your Custom Bar Requirements

**BAR STOCK**  
SPECIALTIES, INC.



[www.GoBarStock.com](http://www.GoBarStock.com)

## FAST ACCURATE PACKAGING

### POLYBAGGING

- CARTONS
- POP BOXES
- ASSEMBLY
- CLAMSHELL
- LABELING / LABELS (BARCODES)
- DROP SHIPPING
- WAREHOUSING



### FASTENERS

- HARDWARE PRODUCTS
- ELECTRICAL
- CRAFT PRODUCTS
- MEDICAL



### MIL-STD-2073 PACKAGING

- MIL-STD-129 LABELING
- ANTI-STATIC BAGS
- KRAFT BAGS
- FOIL BAGS
- WAWF
- RFID
- VSM



*The best quality packaging services  
for the Fastener Industry*



58 Clinton Road Unit B Fairfield, NJ 07004 Phone: 973-882-1711 Fax: 973-882-1742 Email: [npackaging@aol.com](mailto:npackaging@aol.com)

[www.nationwidepackaging.com](http://www.nationwidepackaging.com)

## 20 Years of Fastener Manufacturing

Page 18: Manufacturing History Spans 60 Years

Page 20: Meeting the Challenges

Page 22: Our New Location

**Page 132: Proudly American Made**

Page 134: Planning for a Successful Future

Page 136: Serving Clients Worldwide



## Proudly American Made

Today, V.I.P. produces plastic screws and nuts (both standard and metric), license plate screws and nuts, Christmas tree clips, rivets, wire and cable routing clips, printed circuit board hardware, dowels, washers, spacers, tapped spacer, and many other fasteners for customers all over the world. The V.I.P. production line operates 24 hours a day, seven days a week. All products are proudly American made and have been since the company's inception.

*(continued on page 134)*



**Made in  
the USA**  
Yellville, Arkansas



Pictured from top to bottom, left to right: The V.I.P. management team handles the task of daily operations for the growing company. Pictured with V.I.P. President Joe Volltrauer (seated) are (standing left to right) Jesse Patterson, Tool Room Manager; Heidi Volltrauer-Skiver, Chief Operating Officer; Ran Branaman, Secondary Operations Manager; Chad Avise, Vice President of Operations; Linda Williams, Accounting Manager; Carl McBee, Director of Information Systems; and Ron Schnakenburg, CNC Manager. • Every product Volt manufactures goes through stringent quality checks. Volt's Quality Department takes a measurement to ensure the fastener is within the desired tolerance. • A highlight of the 20th Anniversary Celebration was a flag raising ceremony. • Members of the Alley-White American Legion Post 52 Color Guard salute the flag.

# What do you need?

## Sex Bolts



Including the MALE SCREW and FEMALE SCREWS.  
Various heads. Thread #10-24.  
Length 1/2" - 4". Other sizes available.  
Materials: Steel, Zinc Plated, Stainless Steel.

## Binding Posts & Screws



Including the MALE SCREWS and FEMALE SCREW.  
Thread #8-32. Length 1/8" - 6".  
Other sizes available.  
Material: Aluminum, Brass.

## Blind Rivet Nuts, Blind Jack Nuts & T-Nuts



Round and Hexagon heads. Big and small flanges.  
Open and closed ends. Knurled ones are also available.  
Materials: Aluminum, Brass, Stainless Steel and Steel.

## Clinching Parts (Nuts & Screws)



Bushes, Clinching Nuts, Stand offs, Studs and Spacers. Information on sizes and materials available upon request.

## Self-Tapping Threaded Inserts



Internal thread #2 - 7/8". External thread M4.5 - M36. Provides stronger and more durable permanent threads in plastic.  
Materials: Steel, Brass & Stainless Steel.

## Stretch Folding Blind Rivets



Rivet Dia. 5/32" & 1/5". Length 0.57" - 1".  
Finish available in a multiple of colors.  
Rivet Body: Aluminum 5052.  
Mandrel: Aluminum 5056.

# Ask us.

## IMPERIAL RIVETS & FASTENERS CO. INC.

Office: 7201 Walden Lane, Darien, Illinois, 60561-3734  
Warehouse: Unit H, 8404 S. Wilmette Ave., Darien, Illinois, 60561-3734  
www.imperialrivet.com Email: sales@imperialrivet.com  
Tel: 630-964-0208 Fax: 630-963-0289



## 20 Years of Fastener Manufacturing

Page 18: Manufacturing History Spans 60 Years

Page 20: Meeting the Challenges

Page 22: Our New Location

Page 132: Proudly American Made

**Page 134: Planning for a Successful Future**

Page 136: Serving Clients Worldwide



## Planning for a Successful Future

Although Joe Volltrauer remains the driving force behind V.I.P., the company's daily operations are now overseen by the second generation of the Volltrauer family. Daughter Heidi assumed the role of Chief Operating Officer in 2011. Prior to her role as C.O.O., Heidi Volltrauer-Skiver gained years of valuable experience working at all levels of the manufacturing operation from shipping, administration, and sales to most recently serving as Vice President of Sales and Marketing.

***“We are extremely excited to recognize this milestone in our company’s history. It is a wonderful opportunity to celebrate with our employees, customers, family, and friends who have contributed greatly to our success over the last 20 years. I look forward to a bright future for V.I.P. as we are guided by the customer-focused principles and dedicated work ethic established by my father over 20 years ago,”*** states Heidi Volltrauer-Skiver, Chief Operating Officer.

*(continued on page 136)*

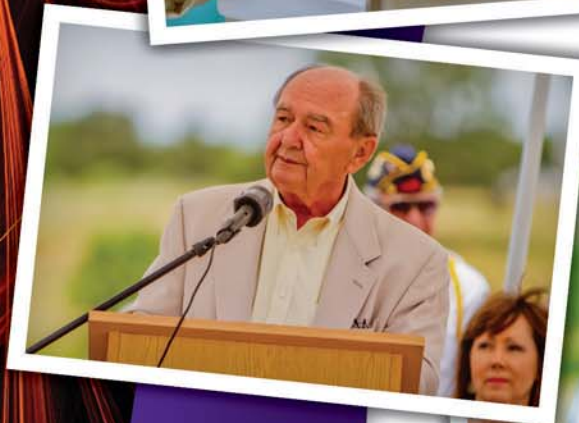
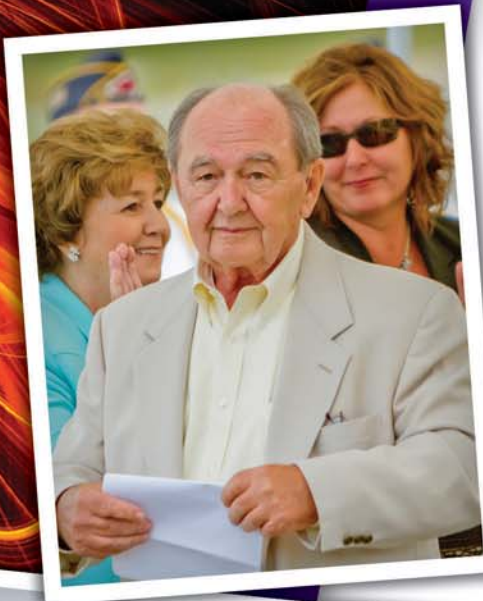

Pictured from top to bottom, left to right: Heidi and Joe Volltrauer enjoy a moment together before cutting the cake. • Joe Volltrauer received much support from his proud family during the ceremony. • Company President and C.E.O, Joe Volltrauer, addresses employees, management staff and friends during the 20th Anniversary Celebration. • Heidi Volltrauer-Skiver, C.O.O. introduces her father Joe Volltrauer, President and C.E.O.

**MORE**

There's lots to do in Kansas City, Missouri



**May 8-9, 2013**

InterContinental®  
Kansas City at the Plaza

**Exhibit or Attend  
the 3rd Annual  
All American  
Fastener Show!**

**NEW  
Location**



## Things to do!

Kauffman Center for the Performing Arts - live theater, dance, concerts

Nelson-Atkins Museum of Art

Casinos nearby (Argosy, Harrah's, Hollywood, Isle of Capri)

Kansas City Speedway

Factory Tours: Hallmark Cards, Harley Davidson, Boulevard Brewing Company

Theme Parks & Water Parks - SEA LIFE Kansas City, Worlds of Fun, Oceans of Fun & Schlitterbahn

- Centrally located in the heart of the U.S.A. - Kansas City, Missouri is easily accessible by plane, car, or train!
- Cost effective way to generate sales leads, introduce new products and enhance your image and visibility.
- Mix business and pleasure within the fastener community.

- **New for 2013 - Free Seminar "Social Media & Internet Marketing" by Brooks-Jeffrey Marketing, Inc.**

## Visit us online, we've made it simple for you to:

- Get all the information you need to know about the show, travel, hotel, things to do, area dining and more!
- Reserve and pay for your exhibit space
- Find out about show sponsorship opportunities
- Attendees can pre-register
- Vote for the 2015 Show Location

**Toll Free 1-877-865-8237**  
**AllAmericanFastenerShow.com**

join us on facebook!



## 20 Years of Fastener Manufacturing

Page 18: Manufacturing History Spans 60 Years  
 Page 20: Meeting the Challenges  
 Page 22: Our New Location  
 Page 132: Proudly American Made  
 Page 134: Planning for a Successful Future  
 Page 136: *Serving Clients Worldwide*



## Serving Clients Worldwide

Volt Industrial Plastics serves clients worldwide from their manufacturing facility located at 700 Hwy 202 West in Yellville, Arkansas. For more information on V.I.P.'s 100% American-Made products and services phone toll-free at 1-800-844-8024 or visit online at [www.VoltPlastics.com](http://www.VoltPlastics.com).



Pictured from top to bottom, left to right: Sophia, V.I.P.'s mascot and Heidi's faithful sidekick • Welcome to Volt Industrial Plastics - pictured is the front hallway entrance to the plant. • The entire Volltrauer family celebrates 20 years of plastic manufacturing. • In-house bagging capabilities means Volt can pre-package fasteners for customers based on their specific needs.



# PICK A "NICHE" ... FOR BIG SAVINGS!

Huge Inventory and Wide Selection  
at Guaranteed Price Savings.

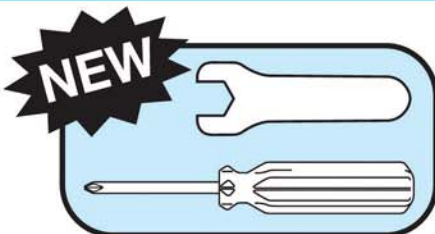

## ECONOMY TOOLS (Disposable Style)

Light duty, single-use style wrenches and screwdrivers. A wide range of sizes and styles available.

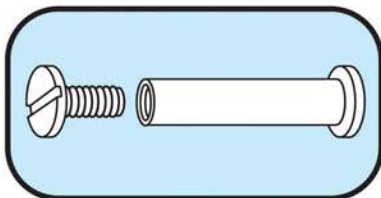

## SEX SCREWS (Male & Female)

Also known as Binder Posts, Chicago Screws. 1/8" thru 6" long & extensions. Other sizes available. Aluminum, Brass & Anodized Black

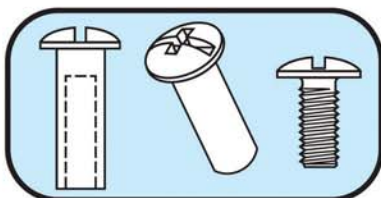

## SEX BOLTS (Male & Female)

Also known as Barrel Bolts, Barrel Nuts. Combo head. 1/4" thru 2" long & extensions. Other sizes available. Steel zinc.

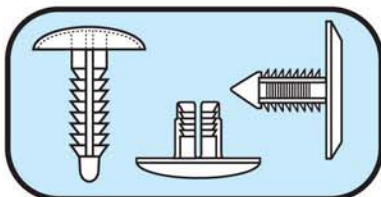

## X-MAS TREE / RATCHET CLIPS

Nylon finned push-in fasteners. Exact matches to several manufacturers' part numbers made on our own multi-cavity tools. Special colors available.

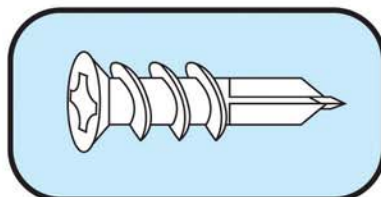

## ZIP-IT® WALL BOARD ANCHORS

Genuine USA made. Self drilling drywall anchors. #6 - #8 screw sizes available in both nylon & zinc alloy.

Lowest prices anywhere. Only \$75.00 minimum.

Call or fax for a FREE catalog, sample kits and/or manufacturers' cross reference number chart.

**Kinter**®

3333 Oak Grove Avenue • Waukegan, Illinois 60087  
800-323-2389 USA • Fax: 847-623-0105  
www.kinter.com



### **Eurolink Fastener Supply Service**

840 South Buncombe Rd, Greer, SC 29650

Tel: 864-801-0505 Fax: 864-801-3606

Email: [craig@eurolinkfss.com](mailto:craig@eurolinkfss.com) [www.eurolinkfss.com](http://www.eurolinkfss.com)

## CITIZENS IN A GLOBAL ECONOMY

Earlier this year, a customer who had gone through the hassle of being “no-quoted” and “no-stocked” by several other metric fastener suppliers paid us an unusual but memorable compliment. She called us expecting to be turned down again. But, as we always do, we found exactly what she was looking for and replied back with a quick quote. After we went over the details, she commented, “You guys are like superheroes...”



Her compliment was greatly appreciated but it also resonated with every one of us, here in the office and the warehouse. Eurolink is an importer/supplier of hard-to-find metric fasteners manufactured to both DIN and ISO standards, so we have a unique perspective on the globalization of business. We understand the value of companies that invest in manufacturing and research facilities around the world. We recognize the impact of jobs, new products and the businesses that are striving to contribute to the global economy. In a time when being a successful business is politically unpopular; we understand that without conscientious corporate citizens the economies on which we all rely will suffer dramatically. To put it simply, we recognize our responsibility to live up to that “superhero” label and to contribute to the marketplace we serve.

A cynic would say, “So what?” And, unfortunately, cynicism becomes a powerful philosophy in a troubled economy. Individuals fail to see what they can do to make a difference and their anxiety is carried over into their workplaces and businesses. But here at Eurolink, we know that individuals and small businesses can make a difference and so we rise to the challenge of being labeled superheroes. We don’t expect to save the world singlehandedly like the characters of comic book fame; but we do know that good business practices, integrity and a determination to success are contagious and empowering.



To respond to the cynic we need more than simple words; we need actions that reinforce ideals. So here’s what we have done:

**Eurolink has added to our sales force** – by expanding our representation around the country we expect to simplify the process of sourcing hard-to-find metric fasteners. Obviously, we are motivated to achieve greater sales but consider the impact on the efficiency of business. When a distributor’s employees can cut hours off the work of finding critical fasteners, their time is freed for greater productivity and increased sales.

*please turn to page 144*





# **Eurolink FSS** **Modern Day Men of Steel**

*and Women*



TM

**Faster than the slow boat  
from China**

**Able to locate "no quote"  
items in a single bound**

**Able to translate DIN EN  
14399-4**

**Stronger than 316Ti  
hex nuts**

**Join us in welcoming Rebekah  
to the Eurolink FSS Team**



**EUROLINK**  
FASTENER SUPPLY SERVICE

**toll-free (866) 787-7594 • [www.EurolinkFSS.com](http://www.EurolinkFSS.com)**

*Hard to Find...Delivered!*

MAFDA - P.O. Box 298, Harleysville PA 19438 • info@mafda.us • www.mafda.us

MID-ATLANTIC FASTENER DISTRIBUTORS ASSOCIATION

# MAFDA ANNUAL GOLF & SCHOLARSHIP CLASSIC

Downingtown Country Club again played host to the MAFDA Annual Golf and Scholarship Classic held on May 21st, 2012. Forty Four Golfers were greeted with fantastic weather (although questionable at the start of the day!), a beautiful leather embossed shoe bag, and opportunities to win a myriad of prizes including electronic devices, a large screen TV, and even a custom engraved baseball bat which was entrusted to the 'lucky' long drive winner!



Steve Gillmor, Lee S. Johnson Associates

place trophies, while team Lubker Distribution finished Second. Greg Cardamone of System 22 won the 'Big Bat' for his long drive blast, easily thirty yards ahead of the nearest player! Congratulations to all!

Raffle and 50/50 drawings followed with lots of fun bantering by both the MC and the crowd. Tricia Murty

Frey was the lucky 50/50 winner, while Steve Cellary of Ford Fasteners was the lucky winner of the 40" Flat Screen Grand Prize.

The evening was concluded with a buffet dinner and the announcement of the scholarship awards. Tricia

Murty Frey (Scholarship Chairperson) had the



Our sponsors this year came out BIG! Stelfast lead the way as Grand Prize Sponsor, Brighton Best continued their tradition of rewarding any hole in one efforts with LOTS of cash (unfortunately no winners,

but many were close), Ford Fasteners sponsored the delicious lunch, Lee S Johnson Assoc. was beverage sponsor, KDS Imports and American Fasteners & Components, Inc. jointly provided a fabulous par three respite including Philly pretzels and fine beverages, and BBC Fasteners along with Solution Industries and Reilly Finishing rounded out the support by providing THE Trophies of the fastener Industry!



honors of announcing the award winners, and the pleasure of personally granting the award to those in attendance. ⬡



Top left: Lee Johnson and Gary Shotlander signing in for golf outing.

Top middle: Winners' trophies

Middle: Scholarship awards

Right: Rick Lubker emcee.

Bottom left: Par 3 sponsors KDS and American Fasteners & Components

Bottom: Lee S Johnson & Associates were the winning team of the event.

The golfers also came out to play. Team Lee S Johnson Assoc. took home the coveted first



## GET THE BENEFITS OF GLOBAL SOURCING

GET DUPAGE PRODUCTS GROUP'S NEW GLOBAL MAINTENANCE KIT ASSORTMENT LINE

## QUALITY KITS! GLOBALLY SOURCED! GLOBALLY PRICED!

THESE KITS HAVE A BROAD MARKET APPEAL.  
A PRIVATE LABEL PROGRAMS FOR THESE KITS IS AVAILABLE.

[www.dupageproducts.com](http://www.dupageproducts.com)

# DuPage® products group

Precision Brand Products, Inc. | DuPage Products Group

2250 Curtiss Street, Downers Grove, IL 60515 USA

Tel: 1-800-323-7208 or 630-968-6900 Fax: 630-969-0310

## AMERICAN IMPERIAL SCREW CORP

### American Imperial Screw Corp

245 Quaker Road, Pomona, NY 10970

Tel: 1-800-431-2391 Fax: 1-845-354-4377

Email: [jay@discountscrews.com](mailto:jay@discountscrews.com)

[www.discountscrews.com](http://www.discountscrews.com)

## AMERICAN IMPERIAL IS BUMAX APPROVED!

American Imperial Screw Corp. is proud to be an authorized distributor for Bumax "Worlds strongest stainless steel bolts" a Bufab Bulten Stainless product. Manufactured from the finest A4 material, the Bumax product line includes hex head cap screws, socket head cap screws, flat head socket screws, Hex lobular pan head thread forming and self-tapping screws, hex and hex flange nuts, flat washers, studs, and threaded rod. They are offered in two high strength classes, Bumax 88 (ISO 8.8) exceeds tensile & yield strength of SAE J429 Grade 5 and Bumax 109 (ISO 10.9) exceeds tensile & yield strength of SAE J429 Grade 8 both with the added benefits of corrosion resistance of up to 3X greater than 316. Bumax should be considered whenever:

- Properties of 316 are required, but tensile strength need to exceed 120ksi
- Steel fasteners with costly finishes are specified
- Steel fasteners are corroding and causing serviceability or cosmetic problems
- Steel fasteners are in an environment susceptible to hydrogen embitterment or stress corrosion cracking
- Application temperatures are unsuitably high or low for carbon or alloy steels
- The cost of multiple lower strength stainless steel fasteners needs to be reduced. (Because of its superior strength, Bumax fasteners can be used in lower quantities to achieve the same or improved clamp loads)
- Component weight and size are an issue (a smaller size Bumax product replaces a much larger lower strength fastener)
- DFARS compliance is necessary

Bumax fasteners are commonly used in areas where the highest level of quality is required for strength and corrosion resistance. Some examples are construction, ship building, oil rigs, pressure vessels, military and defense industry, and various other applications where high strength corrosion fasteners are required. 

# MWFA 31ST ANNUAL FASTENER SHOW MEDINAH BANQUETS, ADDISON, IL - JUNE 26, 2012



# Stamped to Perfection

Every washer, gasket, and stamping we produce meets or exceeds the most stringent specifications. From military specs to your most complex parts, JTD Stamping's Quality, Service and Just-In-Time delivery, are second to none.

Our state-of-the-art tooling and production practices produce the results you expect at costs you can afford. From aluminum to titanium and from in-stock to custom orders, JTD Stamping has provided precision stampings for over 35 years, and with our customers' continued support, we will continue to provide quality stampings for many years to come.

Please do not hesitate to call, write or email us with all your questions and inquiries. We will be happy to quote you on any size order.



**J.T.D. STAMPING CO., Inc.**

*Manufacturers of Washers and Gaskets*

ISO 9001-2000

403 Wyandanch Ave.  
North Babylon, NY 11704

Tel: 631-643-4144  
Toll Free: 1-800-927-7907  
Fax: 631-643-4016

www.jtdstamping.com  
Email: quotes@jtdstamping.com  
info@jtdstamping.com

*J.T.D. Stamping has provided  
Precision Stampings for over 35 years*



**CITIZENS IN A GLOBAL ECONOMY** *continued from page 138*

***Eurolink has expanded our office staff*** - more work demands more workers but we also have a goal of contributing to the economy by being an active employer. It is easy in today's business environment to delay hiring under the argument of uncertainty. We are going to buck that trend and plan for success and the resulting growth.

***Eurolink has moved to an expanded location*** - in July we completed a move to a facility with more office space and a significantly larger warehouse. The move gives us greater capacity for inventory, the ability to bring on even more people, and the space we need to process orders more efficiently.

***Eurolink is participating in industry trade shows*** - as with these other initiatives, it is our goal to grow the business. But trade shows have a positive impact on their host cities, like Las Vegas, and we feel good about our ability to contribute in this way. Through these exhibits we will reach more partners, vendors and

customers with the message that we are here, we are strong and we are moving forward.

We may not really be superheroes, but we're not going to tell ourselves that. We choose to believe that a focus on integrity, success and excellent customer service sets us apart on a grand scale. Let us show you how a focused supply chain partner can ease the work of sourcing metric fasteners of all sizes and materials. Call Eurolink and talk to a superhero today.

Founded in Greer, SC by Craig Penland, Eurolink FSS is guided by one unwavering principle: to work with our customers, not as just another metric fastener importer, but as a supply chain problem solver. Rather than being a massive supplier of common metric fasteners, Eurolink FSS strives to bring a personal touch and a memorable experience to the business of hard-to-find metric fasteners manufactured to both DIN and ISO standards. 

**BLIND RIVET SETTING TOOL MAINTENANCE** *continued from page 114*

### ***6. Hold Setting Tool At Approximately 90 Degrees To Work Piece***

A setting tool should be held at approximately 90 degrees to the work piece. The reason for this is that if the setting tool is at an angle to the work piece, the setting tool will bend the mandrel when the blind rivet is set. A bent mandrel will lodge itself in the setting tool and will not eject from the setting tool.

Also by holding the setting tool at an angle will also break the mandrel of the blind rivet before the blind rivet is set.

### ***7. Push Setting Tool Forward When Setting Blind Rivet***

When setting a blind rivet, if you push forward slightly toward the work piece, you will get a good set rivet. If you set a blind rivet and do not push the setting tool, the flange of the blind rivet would not be flush against the work piece after you set the blind rivet.

### ***8. Special Structural Blind Rivet Nosepiece***

Nosepiece inspection should be performed at the start of each shift. The inspection should entail checking

to see that the nosepiece is tight in the setting tool.

There is one Structural blind rivet that requires a special nosepiece to set this blind rivet. The nosepiece has a small raised ring around the hole of the nosepiece. This ring locks the mandrel in the blind rivet body when this Structural blind rivet is set. If this ring is chipped or worn the mandrel will not lock securely in the rivet body when set.

### ***9. Clean And Lubricated Compressed Air***

An air filter and air lubricator should be installed in the compressed air line near the air/hydraulic setting tool. Clean and lubricated compressed air extends the life of the setting tool. The amount of oil drops into the compressed air line should be according to what the setting tool manufacturer suggests.

### ***10. Air Fittings***

Proper sized air fittings should be used in compressed air lines to operate air/hydraulic blind rivet setting tools. If small diameter air fittings are used, the setting tool will not have the correct volume of compressed air and the setting tool will malfunction. 

# CHOOSE WISELY



*The Retaining Ring Manufacturer with Integrity*

- \* Aggressive Pricing
- \* Guaranteed Traceability
- \* DFARS Compliant
- \* Full Military Certification
- \* ISO 9001 Registered
- \* Made in the USA Since 2002

Tel: 1-866-79-RINGS

[www.smretainingrings.com](http://www.smretainingrings.com)



AUTOMOTIVE | MILITARY | INDUSTRIAL | AEROSPACE

NCFA - 7737 Ellington Place • Mentor, Ohio 44060 • Phone 440-975-9503 • Fax 440-350-1676 • web: www.ncfaonline.com

**NORTH COAST FASTENER ASSOCIATION**

# THE NCFA TURNS 30!

This year is a milestone for the North Coast Fastener Association, as they celebrate 30 years in the fastener industry!

The NCFA was founded in 1982 by a small group of fastener industry entrepreneurs. Their vision was to provide a forum in which the fastener companies could attend educational meetings, develop strong relationships and stay abreast of the events taking place in the fastener industry. Since then, many great people and companies have dedicated their time and invested much effort in making the NCFA what it is today.

On July 14, 2012, the NCFA said "thank you" by celebrating their legacy with a formal dinner gala at the historically elegant Andrews Osborne Academy in Willoughby, OH. The evening included a delicious gourmet dinner followed by a live band where many



danced the night away. In celebration of their history, there were pictures and historical memorabilia to reminisce the days gone by.

The North Coast Fastener Association would like to thank all of the companies that continue to support their association. It is with this support, that the NCFA continues to thrive, bringing their members the type of meetings and networking events they are looking for.

The NCFA is looking forward to another 30 fabulous years!!

If you are interested in joining the NCFA, or would like more information on the association, please visit the website at [www.ncfaonline.com](http://www.ncfaonline.com) or give the office a call at 440-975-9503. ☎



## NCFA 30TH ANNIVERSARY DINNER GALA WILLOUGHBY, OH - JULY 14, 2012







# K-T BOLT

MANUFACTURING CO., INC.

[www.k-tbolt.com](http://www.k-tbolt.com)

Serving the Fastener Industry Since 1969

Manufacturing • Forging  
In a Variety of Head Styles and in Most Grades of Material  
Hot Dipped in Our Facilities



Heading Capacity - 1/2" to 3" Diameter  
Threading to 4" Diameter

Straight, Bent & Welded Anchor Bolts to 4" Diameter

**MADE IN AMERICA TO THE HIGHEST QUALITY STANDARDS AVAILABLE!**

1150 Katy Fort Bend Road, Katy, TX 77493 • P.O. Box 683, Katy, TX 77492

Phone: 800.553.4521 • 281.391.2196 • Fax: 281.391.2673



UNIQUE INDUSTRIES, INC.

- large stock of standards available for immediate delivery: anchor bolts, round u-bolts, wilson anchor sleeves, etc.
- materials: carbon and stainless steel, alloys, copper and aluminum
- dimensional capabilities: 3/16" - 4 1/2", lengths up to 60'
- let Unique Industries produce your custom fasteners in the size, shape, material and finish you need
- 100% traceable



tel 205.668.0490  
fax 205.668.0431  
PO Box 683  
Calera, AL 35040  
sales@uiind.com  
www.uiind.com

MANUFACTURER OF SPECIALTY THREADED ITEMS

OVER 27 YEARS EXPERIENCE IN THE FASTENER INDUSTRY

# MWFA 31ST ANNUAL FASTENER SHOW MEDINAH BANQUETS, ADDISON, IL - JUNE 26, 2012



more photos on page 154

## AN INTRODUCTION TO USA FASTENER GROUP, INC. *continued from page 54*

In conjunction with our approved suppliers, domestic and abroad, USAFG has developed an improved inventory control system and logistics planning program that remain key in meeting customer's demands for on-time deliveries. Direct Mill shipments of raw product are another key benefit. These type of shipments aide in securing USAFG's competitive position in this ever changing market and economy.

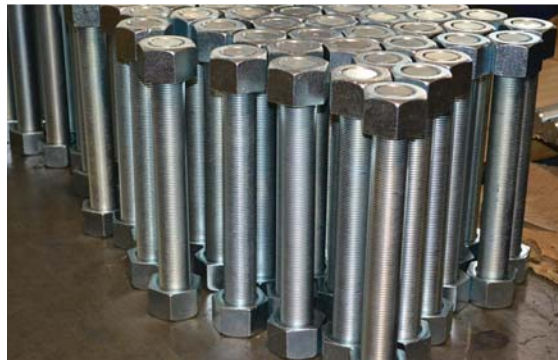

Expanded marketing strategies, including nationwide sales efforts, education, trade shows, and involvement in local associations will keep USAFG in touch with the fastener industry and its surroundings. USAFG's commitment to future growth, including a new website (coming soon) is one of many ways USAFG

intends to keep our customers informed of its growth within the industry.

As a company, USAFG remains steadfast in its pursuit as an industry leader. One such commitment includes adopting ISO 9001:2008 standards. USAFG's future growth plan includes certification by early 2013. Feel free to contact one of our ISO Management Team members for more details. With a bright future ahead, USA Fastener Group, Inc. shall always create and maintain a loyal commitment to customers while constantly looking for methods of improvement. In doing so, USA Fastener Group, Inc. is dedicated to providing its customers with the highest quality products, customer service, and on-time delivery. 





### **Peterson Spring**

21200 Telegraph Road, Southfield, MI 48033

For rings call: 248-355-5489 All other inquiries: 248-355-5838

Email: [sales@pspring.com](mailto:sales@pspring.com)

[www.pspring.com](http://www.pspring.com)

## **PETERSON SPRING INTRODUCES THEIR 'SPECIALTY PRODUCTS DIVISION'**

In addition to the production capabilities of our 12 locations for manufacturing springs, wire forms, retaining rings and spring clips, Peterson Spring has developed a Specialty Products Division (SPD) that can supply all of your small order/prototype requirements for our entire product mix. Our engineers can assist you with the product design as well as offer suggestions for raw material.

SPD offers other special services, such as wire shaping, piercing, bending, coining, grinding, packaging, assembly and painting. Peterson Spring has two locations under the SPD umbrella and both work with each other to ensure your product is given the utmost attention.

Our Specialty Spring Division (SSD), located in Madison Heights Michigan, is equipped to handle all of your short run/prototype spring, wire form, and spring clip needs in a



quick and economical manner. Parts with wire sizes from 0.010" to 0.750" can be produced by SSD. Complete design assistance is available on site if needed.

Our Specialty Ring Division (SRD), located in Holland Ohio, can produce all of your small order snap ring/retaining ring needs, as well as supply your special shaped wire requirements. Retaining rings up to 120" in diameter can be produced

for your applications. Wire sizes ranging from 0.040" to 0.500" can be shaped to your cross sectional requirements.

With quick turnaround on all of your orders and competitive pricing, Peterson Spring's Specialty Products Division is the only company you will need to take on all of your small order/prototype or other special services requirements. 



**PETERSON SPRING**  
MANUFACTURERS OF ENGINEERED METAL PRODUCTS

Wire Forms  
Retaining Rings  
Die Springs  
Stampings  
Compression Springs



Extension Springs  
Torsion Springs  
Clips / Clamps  
Multi Slide Components

GLOBAL SUPPLIER

**We're just wired that way.**

[www.pspring.com](http://www.pspring.com)



30% Growth +  
No Additional Staff =

What Could  
You Do?

# Leading Technology + Exceptional Service

Increase your efficiency, productivity,  
and bottom line. See why industrial and  
fastener distributors choose DDI System.



877-599-4334  
www.ddisys.com  
sales@ddisys.com

## DISTRIBUTOR NEWS

**DDI System** is pleased to announce several new distribution companies that have made the switch to their inform software solution in 2012.



### *Camden Bag & Paper*

*Co* - A United Group member and former StanPak user joined DDI System in March of 2012. Camden Bag is a strong and successful paper and jansan distributor in the competitive NJ market. They boast of an extremely smooth transition process and are quoted as saying, "The DDI Inform Software has exceeded all expectations." Their success is largely due to their rapid adoption of DDI's proven workflows in pricing, order management and product procurement. Camden Bag's willingness to embrace DDI's technology achieved an almost instantaneous increase in efficiency throughout their organization.

*Knight Marketing Corporation of NY* - A ground breaking jansan distribution competitor in the NY metro market switched from AS400 to DDI's inform software in the spring of 2012. This DPA member was looking for software with industry specific tools and excellent customer service for their 20+ users. After comparing Prophet 21 and DDI's inform, inform proved to be the right choice for their complete operations.

*All Florida Paper* - This highly customer-centric paper wholesaler in southern Florida features a complete line of beverage, cleaning and industrial packaging supplies. They are the latest of the many AFFLINK members who have joined DDI System in part due to inform's industry-specific feature set designed for paper and jansan distributors. Converting from StanPak, a system that DDI has converted over 50 times, All Florida Paper rolled out the inform solution to their 30 user staff in February, 2012.

*To find out the benefits of DDI's inform distribution management software and how it will revolutionize your business operations, call DDI System at 1-877-599-4334 or visit www.ddisys.com.*

# N-SPEKT™ 2

## DATA COLLECTION SYSTEM

WWW.N-SPEKT.COM

**Greenslade & Company, Inc.**  
Quality equipment for your quality department

- ◆ Unlimited Inspection Features
- ◆ Gage Validation Status
- ◆ Part or Feature Inspection
- ◆ Data Export to Excel
- ◆ Automatic Part Selection
- ◆ Inspection Feature Histogram
- ◆ HOST / CLIENT architecture (standalone or expandable)

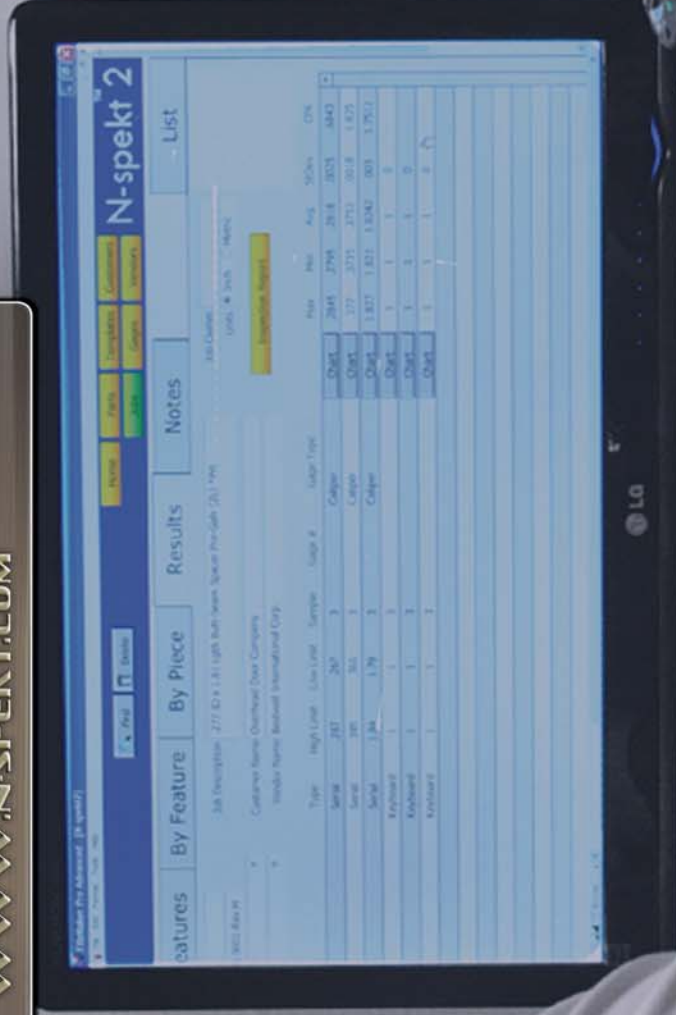

**Why roll the dice with your inspection?**



**When you can use N-Spekt™ 2**

*The world's leading manufacturer of fastener inspection equipment is proud to introduce the newest version in inspection data collection systems!*



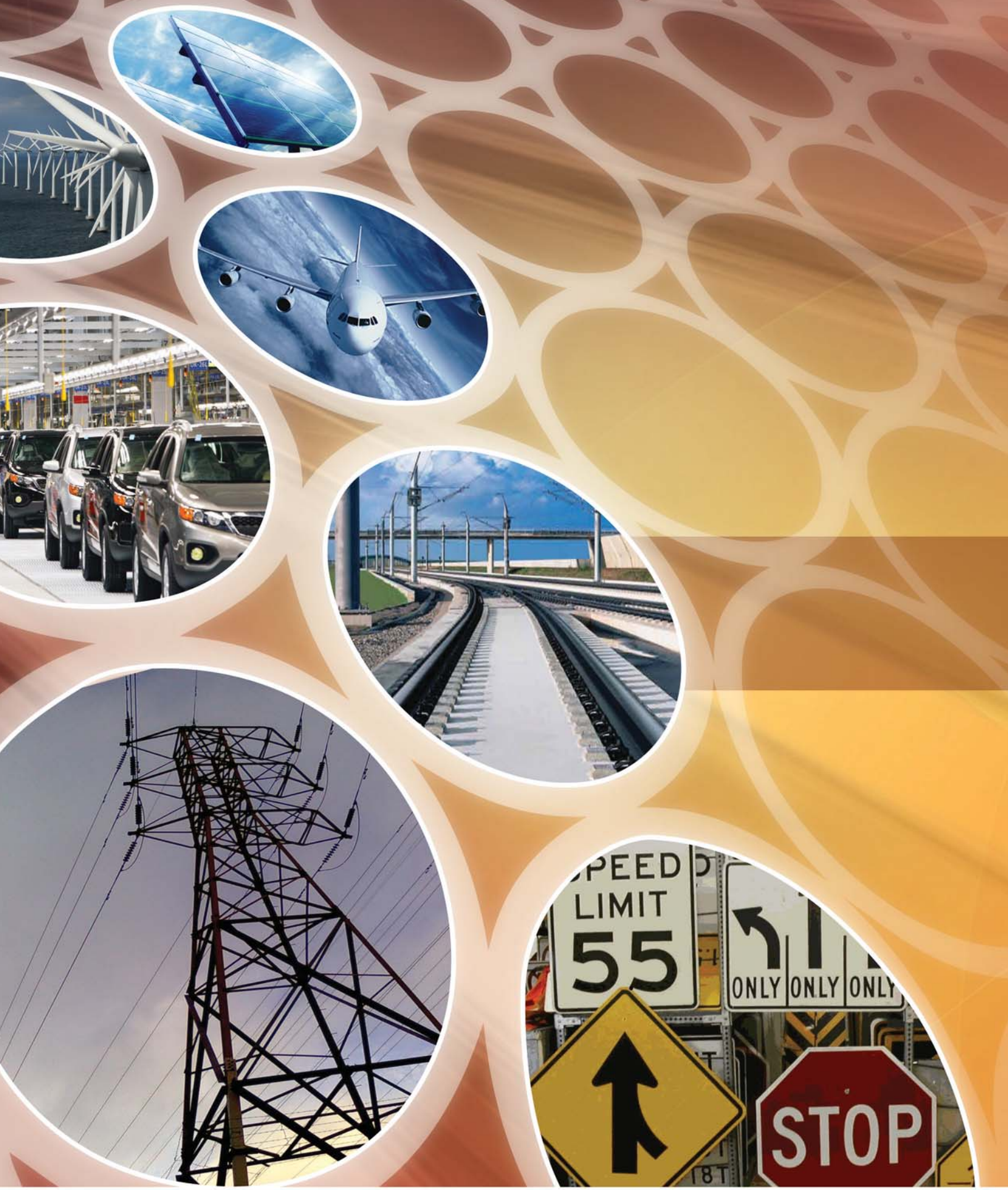

**EXCLUSIVE ALUMINUM SUPPLIER  
PRODUCING MADE IN THE USA PRODUCTS**



## **Providing Specialized Aluminum Fastener Products for Over 30 Years**

TOWER BOLTS  
CARRIAGE BOLTS  
STADIUM SEAT BOLTS  
BUS BAR BOLTS/HEAVY  
SIGN BOLTS/POST CLIP  
VPA12POINT SCREW  
MACHINE SCREWS  
FINISHED HEX NUTS

WOOD SCREWS  
SHEET METAL SCREWS  
THUMB SCREWS  
HEX SELF-DRILL (TEK) SCREWS  
TAMPER PROOF FASTENERS  
THREADED ROD  
BINDING POST AND SCREWS  
HEX HEAD BOLTS/CAP SCREWS

MACHINE SCREW NUTS  
TAMPER PROOF NUTS  
BUS BAR (HEAVY) NUTS  
NYLON INSERT LOCK NUTS  
WING/ACORN CAP NUTS  
SQUARE/FLANGE NUTS  
BEVELED WASHERS  
FLAT & LOCK WASHERS

**Call us toll free: 1.800.526.0341**

**[www.aluminumfastener.com](http://www.aluminumfastener.com)**

TEL: 239.643.4551 FAX: 239.643.5795  
4297 CORPORATE SQUARE . NAPLES . FL 34104

# MWFA 31ST ANNUAL FASTENER SHOW MEDINAH BANQUETS, ADDISON, IL - JUNE 26, 2012







Visit us at Booth #932 in Vegas **FIRST** to receive your **FREE** Pilsner Glass!



**With A Hand Like This,  
Why Wouldn't You Go All-In?**



**It's No Bluff.**

Solution Industries has "RAISED THE STAKES" when it comes to being the **ONE STOP SOLUTION** for all your fastener needs. We are "ALL-IN" as a **VALUED PREFERRED VENDOR**, so let us "DEAL" with your plating, patch, drilling or any special handling needs to increase your bottom line. When choosing your **SECONDARY PROCESS PROVIDER**, you can "BET" on us to be your "ACE IN THE HOLE".

one call - one price - one shipment - one invoice  
**ONE SOLUTION.**

[www.solutionind.com](http://www.solutionind.com)  
866-297-8656

Solution Industries LLC 17830 Englewood Dr. Unit 11 Middleburg Heights, OH 44130



THE  
DISTRIBUTOR'S



# SUBSCRIPTION FORM

## CAN'T WAIT FOR THE NEXT ISSUE OF LINK MAGAZINE? SUBSCRIBE NOW AND DON'T MISS AN ISSUE!

GET YOUR YEARLY SUBSCRIPTION OF  
4 QUARTERLY ISSUES

**UNITED STATES**  
**\$50** PER YEAR  
4 ISSUES

**CANADA & MEXICO**  
**\$60** PER YEAR  
4 ISSUES  
**REST OF THE WORLD**  
**\$70** PER YEAR  
4 ISSUES



COMPANY NAME \_\_\_\_\_

BUSINESS TYPE (CHECK ONE):  FASTENER DISTRIBUTOR  FASTENER MANUFACTURER  FASTENER REP  OTHER \_\_\_\_\_

NAME \_\_\_\_\_

POSITION HELD (CHECK ONE):  PRESIDENT  VICE PRESIDENT  SALES  BUYER  OTHER \_\_\_\_\_

ADDRESS \_\_\_\_\_

ADDRESS \_\_\_\_\_ CITY \_\_\_\_\_ STATE \_\_\_\_\_ ZIP \_\_\_\_\_

PHONE \_\_\_\_\_ EXTENSION \_\_\_\_\_ FAX \_\_\_\_\_

EMAIL ADDRESS \_\_\_\_\_

HOW DID YOU HEAR ABOUT LINK MAGAZINE? (CHECK ONE):  TRADE SHOW  INTERNET SEARCH  RECOMMENDATION  OTHER \_\_\_\_\_

*This fillable form can be completed in Acrobat. Alternatively print and return along with payment to Link at the address below. Payment to be made in US Funds, checks or money orders are accepted - no credit cards. Allow 30 days for delivery of first issue.*

## DISTRIBUTOR'S LINK MAGAZINE . [www.linkmagazine.com](http://www.linkmagazine.com)

mailing address 4297 Corporate Square, Naples, Florida 34104 phone 1.800.356.1639 or 239.643.2713 fax 239.643.5220  
editor & publisher [leo@linkmagazine.com](mailto:leo@linkmagazine.com) advertising sales [maryann@linkmagazine.com](mailto:maryann@linkmagazine.com) director, sales & marketing [tracey@linkmagazine.com](mailto:tracey@linkmagazine.com)

# ABLE LABEL SYSTEMS

LABEL PRINTERS - BARCODE SOFTWARE - FASTENER LABEL SYSTEMS

**Make your own Fastener Labels  
using our "ALWIN" Label System!**



**ALS**



**Create Box & Bin Labels in Seconds!™**

Windows 7 Compatible

Able Label & Bartender Software / Datamax & Zebra Label Printers / Fastener Graphics

Phone: 877-414-5867 [www.ablelabelsystems.com](http://www.ablelabelsystems.com) E-mail: [sales@ablelabelsystems.com](mailto:sales@ablelabelsystems.com)

*"The Good Guys"*

**Fascomp**  
electronic hardware

**World's most comprehensive inventory in both English & Metric sizes**

**What Sets Us Apart**

- Outstanding Customer Service
- Unmatched Distributor Support
- Quick Deliveries on Special Sizes
- Attractive Prices
- Excellent Quality
- A Supplier You Can Trust
- We Produce Specials Made To Print
- Over 50,000 items in Stock
- The Most Efficient, Sophisticated & Wide Ranging Machining Capabilities

- Male-Female Standoffs
- Female Standoffs
- Male-Male Standoffs
- Spacers
- Shoulder Screws
- Captive Screws
- Thumbscrews
- Swage Standoffs & Spacers
- Handles and Ferrules
- Jackscrews

**Fascomp now stocks a full line of instrumentation Handles and Ferrules**

**"The Good Guys"**

Our commitment to you "No supplier will work more diligently for you, our customer and partner in business."

7814 Kingspointe Pkwy Orlando, FL 32819  
Tel (407) 226-2112 • Fax (407) 226-3370

550 Spring Street Naugatuck, CT 06770  
Tel (203) 720-1146 • Fax (203) 720-1156

**VISIT US AT [WWW.FASCOMP.COM](http://WWW.FASCOMP.COM)**

NEFDA - 30 Hedgerow, Wethersfield, CT 06107 • Tel: 860.529.4539 • Email: jfs3@cox.net • www.nefda.com

## NEW ENGLAND FASTENER DISTRIBUTORS ASSOCIATION

# NEFDA 2012 SCHOLARSHIP GOLF OUTING

by Peter Wisk

Oak Ridge Golf Course in Feeding Hills, Massachusetts was once again the scene for the New England Fastener Distributor's Association annual Scholarship Golf Outing on June 5, 2012. This year was the 24th such event. The outing has become the association's largest fundraiser for its scholarship fund. This year was no exception.

Eighty-four golfers were treated to a hamburger and hot dog lunch along with the usual amenities. There are always new faces at the golf outing, so there was plenty of opportunity to make a new acquaintance or two. Of course, many old friendships were renewed.

The skies at Feeding Hills were cloudy and threatening all morning as play got under way with a shot gun start promptly at 12:00 noon. But while the golfers had to endure a light shower or two for about the first hour of play, the weather behaved for the rest of the day, gradually clearing and becoming comfortably cool and breezy. Play was quite prompt and all were finished by 4:30 pm.

The 160 yard 4th hole par 3 was the scene of the double your money tee shot. Many wagered on their ability to hit the green with their tee shot, and quite a few succeeded in doubling their money. But the golfers were generous, as many who hit the green donated their winnings to the scholarship, and we were able to raise over \$300 at the hole. The 4th hole was also the scene of the hole in one contest sponsored by Brighton-Best International. Alas, there were no winners!!

The contest hole results were:

### Men's Longest Drive

Alex Maxfield, NEFCO

### Women's Longest Drive

Carrie Ingham, Specialty Bolt & Screw

### Closest to the Pin

Dave Monti, Fall River Mfg. Co. and Tom Grover, Stelfast, Inc.



The golf winners were:

### 1st Gross

Dave Monti, Fall River Mfg. Co.  
John Conti, Fall River Mfg. Co.  
John Moynihan, Callahan & Moynihan Associates  
Joel Roseman, Arnold Industries, Inc.

### 2nd Gross

Wayne Wishnew, XL Screw  
Skip Maxfield, NEFCO  
Harrison Maxfield, NEFCO  
Alex Maxfield, NEFCO

### 1st Net

Jim Condangelo, Jim Grazlusi, Mike Velardi, Phil Hood,  
Electronic Fasteners, Inc.

### 2nd Net

Fred Barr, O.J. Simpson, Steve Daniels, Tom Grover,  
Stelfast, Inc.

About 100 attended the evening's buffet dinner, awards presentation, and raffle. John Conte and his Golf Committee out did themselves with the raffle, as there were too many prizes to count! There were certainly more than enough prizes to win, ranging from golf clubs and tee shirts to a power washer and a 39" flat screen TV.

Of course, the most important part is the fact that the NEFDA was able to raise over \$10,000 for the Scholarship / Member Education Fund. And the association is grateful to those who worked on the outing and those sponsors who contributed support in the form of hole and and tee sponsorships or raffle prizes.

We acknowledge them as they deserve your recognition!!

### Our Premium Sponsors

Brighton-Best International  
Fall River Manufacturing Co. Inc.  
Star Stainless Screw Co.  
Stelfast Inc.  
ND Industries  
Kanebridge Corporation  
XL Screw Corporation

please turn to page 183



# ALLOY & STAINLESS FASTENERS



**Bolts · Nuts · Studs · Sockets · Washers  
Bent Bolts · Machined Parts · Threaded Rod  
Manufactured to Your Specific Requirements**

**Special Metal Fastener Specialists**

**Your **SPECIALS** are our **STANDARDS****



No Minimum Quantity



60,000 Inventory Items



10,000 Ton Inventory



Over 250 Machines



24-7 "SOS" Service

**Quick Delivery is our Specialty**

[www.GoASF.com](http://www.GoASF.com)



## The Bolt Barn®

*All your hardware needs in one convenient location!*

The Bolt Barn® by Trinity is the perfect solution to managing, merchandising and replenishing your retail hardware. This unique stand-alone structure is sure to generate plenty of customer buzz and repeat business. And thanks to Trinity's inventory technology, you control the volume making The Bolt Barn® ideal for minimizing costs and maximizing value.

Each Bolt Barn® is built onsite and includes:

- 15' x 22' American Made Barn with free installation & set-up
- Merchandizing cabinets containing more than 1,000 Sure-Lok® pans (with dividers)
- More than 2,000 items and 18,000 lbs. of hardware
- ScanSwift Scanner and set-up for easy ordering and replenishment

For more information, contact: Dan Zehnder  
563-459-6341  
dzehnder@trinitylogisticsgroup.com



maximizing value. Trinity's ScanSwift system makes ordering and replenishment easy, putting you in control of what is ordered, when it's ordered.... AND in what volume! No more over stocking your bins. The ScanSwift system improves the efficiency of the ordering process, provides review of order prior to submission, expedites shipping, and increases productivity.

Each Bolt Barn® is built onsite and includes a 15'x22' American made barn with free installation and set-up, merchandizing cabinets containing more than 1,000 Sure-Lok® pans with dividers, more than 2,000 items and 18,000 lbs. of hardware, and the ScanSwift system. The Bolt Barn® can be provided without hardware, if you choose to use your own inventory.

The Bolt Barn is not for everyone. You might be the only kid on the block that has one. However, the

ScanSwift system IS something that everyone can use. A complete controlled-inventory approach to small parts and low-cost items, the ScanSwift system is ideal for managing multiple parts from multiple suppliers. This consolidation saves you time and money and provides the tracking and history management you want.

*To consider The Bolt Barn® for your operation or installation at your customer's location, please contact Dan Zehnder at Trinity, 563-459-6341 or email at dzehnder@trinitylogisticsgroup.com.*

## DISTRIBUTOR NEWS

If you are looking to increase your hardware inventory but do not have the floor space, **Trinity** has the answer.

Trinity's new Bolt Barn® provides valuable added space and is the perfect solution to managing, merchandising and replenishing your hardware needs.

The Bolt Barn® is an attractive, stand-alone structure that will be sure to generate plenty of customer buzz and repeat business.

You control the inventory volume making The Bolt Barn® ideal for minimizing costs and

# YOUR SOURCE

## For Standard And Specialized Fasteners

Cotter pins, hitch pin clips, spring pins, clinch pins and more pins. Pins for industry. Pins for agriculture. Pins for OEM. Pins for every purpose and much, much more. From lock washers, D-rings, key rings and S-hooks. We offer our products in various sizes, shapes, materials and finishes. Check out our website for complete product details.

When applicable and specified, our pins conform to federal specifications. Supporting material test reports are kept on file.

As a proud USA manufacturer, we produce an extensive line of standard and specialized fasteners. Give us a call and let us show you why people have been relying on Western Wire Products since 1914.

## And Let Us Give You A Hand With Customized Wire Shapes & Forms

If one of our standard parts will not meet your needs, we would be glad to give you a quote on a customized shape, stamping, or form made to your specifications.



**Western Wire Products Co.**  
Since 1914

770 Sun Park Drive • Fenton, MO 63026 • 800-325-3770 • FAX 636-305-1119  
e-mail: [sales@westernwireprod.com](mailto:sales@westernwireprod.com) [www.westernwireprod.com](http://www.westernwireprod.com)



MFDA - P.O. Box 1477, Wayne NJ 07470 • Tel: 201.644.7424 • Fax: 201.644.7427 • Email: admin@mfgda.us

## METROPOLITAN FASTENER DISTRIBUTORS ASSOCIATION, INC

# MFDA AWARDS \$18,000 IN SCHOLARSHIPS AT ITS 33rd ANNUAL AWARDS MEETING *by Barb Traum*

The Metropolitan Fastener Distributors Association held their 33rd annual scholarship awards meeting on June 19th at Al Di La Restaurant in East Rutherford, New Jersey awarding a total of \$18,000 in scholarships to deserving students in the industry.

Lloyd Abraham, son of Lalu Abraham, a QC Inspector at Columbia Nut & Bolt, received the Board of Directors Scholarship in the amount of \$3,000. The Century Fasteners Scholarship in the amount of \$2500 was presented to Louis Mareello, son of Mary Mareello, Assistant Sales Manager at Metric & Multistandard. The Tanzman Family Scholarship in the amount of \$1500 was presented to Melissa McGowan, daughter of Denise McGowan, Inside Sales at Brighton Best International.

Andrew Rhinesmith, son of Stephen Rhinesmith, QC Manager at Captive Fasteners was awarded the Tower Fastener Scholarship in the amount of \$1250. The ND Industries Scholarship in the amount of \$1000 was awarded to Nicholas Rogers, son of Steven Rogers, Key Account Manager at Tower Fasteners. Nicoletta DelRosso, daughter of Angela DelRosso, Payroll Department of Columbia Nut & Bolt, received a \$1000 MFDA Scholarship.

Ryan Knapp & Eric Knapp, sons of Janet Knapp, an administrative assistant at ND Industries both received scholarships. Ryan received the Metric & Multistandard Scholarship in the amount of \$1000 and Eric was awarded a \$750 MFDA Scholarship.

Alyssa Briana Nirmaier, daughter of Kellie Nirmaier, CSR at Kanebridge Corp was awarded an MFDA Scholarship in the amount of \$750. Courtney Fee, daughter of George Fee, Sales Manager at Baco Fasteners received a \$750 MFDA Scholarship.

The Ben Rockland/Murray Laufer Scholarship in the amount of \$750 was awarded to Danielle Pimentel, the daughter of Elsa Pimentel, QC Manager at Columbia Nut & Bolt. Elizabeth Gruhl, daughter of Kenneth Gruhl,



Assistant Purchasing Manager at Metric & Multistandard, received a \$750 MFDA Scholarship.

Frank Palatucci, son of Rosanna Palatucci, Office Manager at Ford Fasteners received a MFDA Scholarship in the amount of \$750. A \$750 MFDA



Scholarship was awarded to Karla Correa, daughter of Martin Correa, QC Inspector at Captive Fasteners. Kristin Payne, daughter of Steve Payne from Safety Socket received a \$750 MFDA Scholarship. Odalis Cardenas, daughter of Franklin Cardenas, Maintenance Technician at Capitive Fasteners received a \$750 MFDA Scholarship.

In addition to the scholarships presented, the MFDA recognized former members of the scholarship committee. Plaques of appreciation were presented to Ed Werner, EZ Sockets, Marty Schneider, Continental Aero, and Irwin Tanzman. Steve Matthews, Secure Fastener was recognized as well but was unable to attend.



**Thank you to the following companies and individuals for their generous donations to this year's scholarship drive:**

Aerospace Nylok Corp., American Global Co., Baco Enterprises, Beron Associates, BMB Fasteners, Brighton-Best International, Captive Fasteners, Century Fasteners, Columbia Nut & Bolt, Continental Aero, Crescent Manufacturing, Delta Secondary (In memory of Walter Kielar), E Z Sockets, Inc. (In memory of Isador B. Mintz), Efron, Marilyn & James, Fall River Mfg. Co., Fastbolt Corporation, Ford Fasteners, G K Y Industries, Hardware Specialty, Kanebridge Corp., Ken Forging, Inc., Lee S. Johnson Associates, Leo J. Coar Associates, McCormick Associates, Merchants Fastener Corp., Metric & Multistandard, Mutual Screw & Supply, ND Industries, Prestige Stamping, R.W. Rundle Associates, Safety Socket, LLC., Smith Associates, Swiss Stainless, Tanzman Family, Tower Fasteners, Uneeda Bolt & Screw (In memory of Alice Brickman), Weinstock Bros., and Yellow Transportation. 





## It's always springtime, when I use Ajax Springs

At Ajax Wire in addition to a growing list of stock springs we carry a line of equivalent springs for Select-A-Spring, Century's Hardware line, Associated Spring, Lee Spring, Gardner Spring, Servalite, Midwest Spring and Curtis.

Ajax also offers several assortments that come with display board and cabinets. They feature a full range of spring sizes that are suitable for manufacturers to place in their maintenance and tool cribs.

Springs have been our only business for 77 years and three generations, and our aim as always is to continue to provide you with quality spring products.



Call Ajax Springs today and ask for our new Product Catalog!



Toll Free: 800-966-AJAX (2529)  
119 Bloomingdale Road, Hicksville, NY 11801  
www.ajaxwire.com ajaxwire@aol.com

# Drilled Fillister Specialists

## BRASS STAINLESS STEEL

# EMPIRE FASTENERS INC.

12-10 30th Avenue Long Island City, NY 11102  
(800) 598-5212 • (718) 728-3900 • Fax (718) 726-4067

Empire  
Manufactures  
and Stocks

AN 500A	AN501A
MS 35265	MS 35266
MS 35271	MS 35272
MS 35273	MS 35274
MS 35275	MS 35276
MS 35277	MS 35278

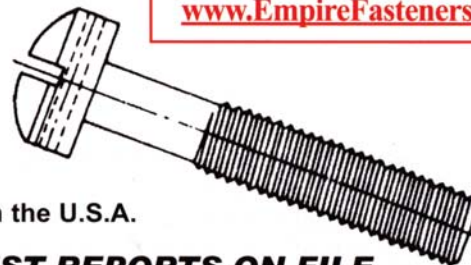
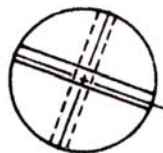

NEW...  
NOW CHECK STOCK & E-MAIL QUOTES  
ON LINE  
[www.EmpireFastenersInc.com](http://www.EmpireFastenersInc.com)

• Manufactured in the U.S.A.

**ALL CERTIFICATIONS AND TEST REPORTS ON FILE**  
**All Requirements are in accordance with:**

- Quality Control: MIL-I-45208 A  
MIL-STD-45662 A
- Steel Drilled Screws: Fed. Std. No. 66

- Plated Cadmium: Per QQ-P-416, Type 2 CL 3
- Stainless: UNS-S30430
- Passivation: Per QQ-P-35

All screws are tested to meet the Tensile requirements of procurement spec. FF-S-92B

# ZnCoat™

## NEW Plating Alternative

**ZnCoat** takes surface treatment to the next level of performance and quality

- Offers 4x improvement in corrosion resistance vs. commercial zinc/trivalent plating
- Does not promote hydrogen embrittlement
- Is RoHS and REACH compliant
- Offers improved bi-metallic corrosion protection
- Thin coating - compatible with standard thread allowances
- Licensed process for consistent quality
- All of these features at **no extra cost**



**Now Available in Black and Yellow!**

Exclusively Available Through:

**CURTIS** Metal Finishing Company

Sterling Heights, Michigan • Machesney Park, Illinois

Contact Brian Lowry @ (586) 939-2850 or [brianl@curtismet.com](mailto:brianl@curtismet.com)

***info@ZnCoat.com***  
***ZnCoat.com***

ASTM B117 Salt Spray  
Test Comparison

**ZnCoat** @ 240 Hours SST



Zinc Plating @ 72 Hours SST



ZnCoat™ is a pending trademark application of NOF Metal Coatings North America Inc.



**NATIONAL**  
THREADED FASTENERS, LTD.

[www.flangescrews.com](http://www.flangescrews.com)

phone: 440.350.1430 | fax: 440.350.1676  
3705 Lane Rd. Perry, OH 44081  
[sales@flangescrews.com](mailto:sales@flangescrews.com)

**KNOWLEDGEABLE CUSTOMER SERVICE**

**SAME DAY / NEXT DAY SHIPPING**

**QUARTER KEG & PACKAGE QUANTITIES**

**BLANKET & MILL SHIPMENTS**

**VARIETY OF STOCK FINISHES**

**QUICK QUOTE TURN AROUND**

**BARCODED LABELS**

## **FLANGE SCREWS**

### **INCH**

GRADE 5 HEX FLANGE SCREWS  
GRADE 8 HEX FLANGE SCREWS  
**New** GRADE 8 ASME HEX FLANGE SCREWS  
GRADE 5 SERRATED FLANGE SCREWS  
GRADE 5 LARGE SERR FLANGE SCREWS  
GRADE 8 SERRATED FLANGE SCREWS  
GRADE 2 FLANGE LAG SCREWS

### **METRIC**

CLASS 8.8 DIN FLANGE SCREWS  
CLASS 10.9 DIN FLANGE SCREWS  
CLASS 10.9 JIS FLANGE SCREWS  
CLASS 8.8 SERR FLANGE SCREWS

## **FLANGE NUTS**

### **INCH**

GRADE 5 FLANGE NUTS  
GRADE 8 FLANGE NUTS  
GRADE G FLANGE LOCKNUTS  
**New** GRADE F NYLON INSERT FLANGE NUTS  
SERRATED FLANGE LOCKNUTS  
**New** GRADE 5 SERR FLANGE LOCKNUTS  
GRADE 8 SERR FLANGE LOCKNUTS  
SERR LARGE FLANGE LOCKNUTS

### **METRIC**

CLASS 10 JIS FLANGE NUTS  
CLASS 10 JIS SERR FLANGE NUTS  
CLASS 10 DIN FLANGE NUTS  
CLASS 10 DIN FLANGE LOCKNUTS  
CLASS 8 SERRATED FLANGE NUTS

## **THICK FLAT WASHERS** **New**

USS & SAE "NT" HARDENED  
USS & SAE "NT2" HARDENED  
SAE "NTX" HARDENED  
EXTRA THICK FENDER WASHERS

PROUD MEMBER: NFDA, NCFA, MWFA



**DIN - A DIN-OSAUR?** *continued from page 8*

For those of you who are still specifying DIN 931, DIN 933, DIN 934, etc. keep in mind that they were withdrawn as German standards many years ago. If we in the US insist on clinging to the past this way, we are only preserving an old DIN system abandoned by the German industries. By ordering fasteners to those old standards we are forcing the fastener manufacturers around the world to maintain tooling for both old DIN and today's ISO. Very few US industries specify the ASME standards for fasteners because they are not readily available. These US metric standards are now rapidly fading out for that reason.

What the US fastener market (end users, manufacturers, distributors, etc.) must do to avoid further misunderstandings, is to use ISO standards across the board.

**AND DO IT NOW!**

One area that have helped preserving the obsolete DIN specifications is the WAF (width across flats) for Hex Head Screws, sizes M10, M12 and M14 (avoid using this size anyway). The ISO WAF for the three sizes is 1 mm smaller than the obsolete DIN sizes. Most people probably don't realize the enormous material savings we get by using the 1 mm smaller sizes. And, there are no technical reasons for not changing the WAF from a joint design point of view. In Table 1 below I have calculated a couple of important variables that can have an impact on the bolted joint itself with respect to the smaller head sizes.

1. The ratio between the thread stress area,  $A_s$ , and the compression area under the head,  $A_{dw}$  (based on the washer face) should show some consistency between screw sizes.
2. How high is the relative surface pressure generated by the various head sizes?

For M10 I have used both 15 (old OMFS), 16 (current ISO) and 17 (old DIN). I also added M16 and M20 to have some relative comparison of ratios. The surface pressure is calculated on ISO Class 8.8, using the proofing load level (about 90 % of Rp0.2 or yield).

Table 1

Thread size	WAF mm	$A_s$ mm <sup>2</sup>	$A_{dw}$ mm <sup>2</sup>	$A_{dw}/A_s$	Surface pressure MPa (N/mm <sup>2</sup> )
M10	15	58	149	2.6	624
	16		168	2.9	461
	17		197	3.4	330
M12	18	84.3	217	2.6	582
	19		237	2.8	-
M14 <sup>1)</sup>	21	115	294	2.6	570
	22		330	2.9	-
M16	24	157	397	2.5	580
M20	30	245	624	2.5	602

1) Not preferred ISO choice for Hex Cap Screws

A normal ratio for  $A_{dw}/A_s$  is 2.5-2.6. For M10, both the old 17 and the new 16 have higher ratios than the average, also giving lower relative surface pressures. For M12 I used a 13 mm clearance hole since 13.5 (medium) reduces the bearing area more than I like. If we really need larger bearing areas, we should consider using Flange Screws.

The following is a "short list" of current ISO standards and the obsolete DIN and ASME B18 standards they replace:

ISO	REPLACES
ISO 4014	DIN 931 ( <i>partly threaded</i> ) ASME B18.2.3.1M ( <i>partly threaded</i> )
ISO 4017	DIN 933 ( <i>fully threaded</i> ) ASME B18.2.3.1M ( <i>fully threaded</i> )
ISO 4032 ( <i>style 1</i> )	DIN 934 ASME B18.2.4.1M
ISO 4033 ( <i>style 2</i> )	DIN 934 ASME B18.2.4.2M
ISO 4035 ( <i>low</i> )	DIN 439B ASME B18.2.4.5M
ISO 8678	DIN 603 ASME B18.5.2.1M

In addition we should also change Socket Head Cap screws and machine screw standards to ISO even if they are not affected by the WAF change for Hex Screws and Hex Nuts.

**Conclusion**

According to documentations I have received from Germany, DIN 931 was withdrawn 1987, DIN 933 withdrawn 1992 and DIN 934 withdrawn 1992. They also had a transition period set to end 1992. Looks like we have had enough time to adjust!

May I suggest that all of us fastener professionals follow the lead set by Joe Greenslade, IFI, and the committee members of ASME B18 and ASTM F16 to phase out the US metric standards and get moving to the ISO. The United States is an important member of ISO and if we have a need for revisions of current ISO standards we should be able to influence TC 2 without having to publish our own unique documents.

**Suggestions to the Fastener Trade:**

1. Revise all your metric documentations (catalogues, etc.) from DIN to ISO. Don't wait – do it NOW!
2. Coordinate the changes with your customers.
3. Train your and your customers, personnel, it will pay off.

**Make DIN-osaurus HEX extinct like Tyrannosaurus REX!** 

# CAVALIER Industrial Specialties

## Industrial Studs



**Continuous Thread  
Single End • Double End • Tap End  
Made per Drawing**



## Machined Parts



**Manufactured under  
our Documented  
Quality Assurance Program**

[www.GoCAV.com](http://www.GoCAV.com)



### **Field Fastener Supply Company**

9883 N. Alpine Road, Machesney Park, IL 61132  
Tel: 815-637-9002 Fax: 815-637-7575  
[www.fieldfastener.com](http://www.fieldfastener.com)

## **FIELD FASTENER MAKES INC 500|5000 FOR THE 2nd CONSECUTIVE YEAR**

Field Fastener, a global fastener distributor, announced today that it has once again been named one of the fastest growing private companies in America, earning its spot on the Inc. 500|5000 list for the 2nd consecutive year.

The Inc. 500|5000 list is an exclusive ranking of the nation's fastest growing private companies. With 31% growth in revenue over a three year span, Field Fastener was ranked #4149 overall on this year's list and #165 for the manufacturing industry.

"We are honored to once again be recognized by Inc. magazine, and counted among other top growth companies in the US", said Field president, Bill Derry. "We have a value proposition that truly lowers our customers' costs and improves their competitive position. Our team is dedicated and well trained, a combination that has resulted in superior growth, not just in the past 3 years, but for the past 20 and will be the case for the foreseeable future."

As a leader in the competitive fastener distribution industry, Field has built its reputation on meeting customers'

cost reduction, material availability and quality by utilizing superior systems, team members, and suppliers. Field provides value added activities and cost reduction solutions through various services, including vendor inventory management programs and technical support services.

"Even in a stagnant economic environment, Field continues to see impressive growth by providing industry leading engineering and technical support, resulting in viable cost reduction solutions for fasteners and other class c commodities", said Field Executive Vice President, Jim Derry.

"Now more than ever, we depend on the Inc. 500|5000 companies to spur innovation, provide jobs, and drive the economy forward," states Inc. magazine Editor Eric Schurenberg. "Growth companies, not large corporations, are where the action is"

Since appearing on the 2011 Inc. 500|5000 list, Field opened a new \$3 Million Dollar facility expansion and completed its acquisition of Fastening Solutions LLC, a division of Duncan Bolt. 

# MEASURE MATE®

## THREAD CHECKING SYSTEMS



- Available in both INCH and METRIC.
- The perfect tool for use in retail, manufacturing shops, and tool cribs.
- Can be customized with your own company logo.
- Exclusive Patented Design: U.S. Patent # D620,378S

Call  
For  
Your  
New  
500+  
Page  
Catalog!



TRINITY  
HARDWARE HEADQUARTERS®  
PARTS DONE RIGHT.

Toll free:  
**888.232.1010**

Fax: **563.441.6760**

Web:  
**TrinityHardwareHQ.com**

Email:  
**Sales@  
TrinityHardwareHQ.com**

Visit us at the National Industrial Fastener Show, Booth 827  
October 11 - 12, 2012, Las Vegas, Nevada

## DISTRIBUTOR NEWS

In its recent Board of Directors meeting **Batching Systems, Inc.** unanimously appointed John Staruch to serve as a member of the Board as well as Vice President and General Manager of the Company.

In his new roles Staruch will assist in defining strategic business objectives and be responsible for the day to day management of the company. "Batching Systems' entrepreneurial mindset and disposition for quick decision-making is a perfect fit for my managerial style," stated Staruch.

Batching Systems, Inc. (BSI) is a recognized leader in volumetric weighing, counting, batching and filling technology. Founded in 1989, the Company remains privately owned and continues to provide high technology filling and packaging solutions to the industrial, food, and medical industries. BSI systems are highly engineered and rugged offering reliability and precision filling accuracy while at the same time providing maximum operational flexibility.

For more information on BSI and the solutions we provide in high-speed counting applications, call 410-414-8111. Alternatively, you can e-mail us at [sales@batchingsystems.com](mailto:sales@batchingsystems.com) or visit us online at [www.batchingsystems.com](http://www.batchingsystems.com).

## DISTRIBUTOR NEWS

**Manasquan Premium Fasteners LLC** named Ryan Unick market development manager. His role includes local and national market development, managing the company's marketing and social media campaigns and supervising product line expansion.

Manasquan co-owner Bob Day commented that Unick "possesses a combined knowledge of the building and fastening industries that is

extremely rare in today's business world."

Founded in 1987, Manasquan supplies stainless steel fasteners for residential, commercial and marine construction industries in North America, the Middle East, Latin America and Asia.

For more information contact Manasquan at 1-800-542-1979, email: [info@manasquanfasteners.com](mailto:info@manasquanfasteners.com) or at [www.manasquanfasteners.com](http://www.manasquanfasteners.com).

# OUT OF THE AMERICAN WEST...

## MAR-BRO LEADS THE WAY IN STANDARD & SPECIAL SCREWS

MAR-BRO MANUFACTURING INC., WITH 30 YEARS OF COLD HEADING EXCELLENCE IS PROUD TO ANNOUNCE THE NEW PRODUCTION OF MILITARY STANDARDS, M.S. AND N.A.S. SOCKET HEAD PRODUCTS WITH FULL TEST REPORTS AT NO ADDITIONAL CHARGE. ALL MATERIAL WILL BE D.F.A.R.S. COMPLIANT.

ASK ABOUT OUR WIDE RANGE OF PRODUCTS INCLUDING:

### NEW PRODUCTS

HEX FLANGE SCREWS  
12 POINT FLANGE SCREWS  
PENTA FLANGE BOLTS  
HEX HEAD CAP SCREWS

### SIZE RANGE

INCH AND METRIC  
#00-5/8 DIAMETER  
M1.6-M16 DIAMETER  
LENGTH UP TO 8"

### NEW MATERIALS

INCONEL®  
A 286 & 17-4 PH  
188 STAINLESS, 125 KSI MIN.  
ASTM A193 CL 1 & CL 2



MAR-BRO MANUFACTURING INC.  
5717 W. WASHINGTON PHOENIX, AZ. 85043  
TEL: (602) 278-8197 FAX: (602) 269-1235



TESTING CERT #1272.01

# MWFA GOLF OUTING AND BANQUET EAGLEWOOD RESORT, ITASCA, IL - JUNE 26, 2012







### Rumco Fastener Division

989 Pauly Drive, Elk Grove Village, IL 60007

Tel: 1-800-537-8626 Fax: 847-364-4104

Email: [info@mw-ind.com](mailto:info@mw-ind.com)

[www.mw-ind.com/divisions/rumco](http://www.mw-ind.com/divisions/rumco)

## RUMCO FASTENERS HAVE BEEN SECURING YOUR PRODUCTS FOR OVER 25 YEARS

As a leading cold-heading fastener manufacturer, Rumco Fastener Division specializes in a wide variety of SEMS and custom fastener products. Rumco's customers have made us their manufacturer of choice because of our ability to meet custom requirements, our depth of product lines, our manufacturing capabilities and our ongoing commitment to customer satisfaction.

With over 50 years experience in the fastener industry, our inside sales team takes pride in supporting and servicing your every need, including order tracking, technical expertise, service recommendations and 24-hour quotes on specials.

We have a complete range of manufacturing equipment allowing us to make quick, efficient production runs. Whether your order is for 1,000 or a

million pieces, Rumco has all the resources to meet your fastener requirements, including Slotting, Rolling, SEMS rolling, Shank slotting, Trimming, Heading & Multi-blow transfer headers

Rumco specializes in SEMS and fasteners including 2-, 3- and 4-piece assemblies, in ferrous and non-ferrous materials, with standard, cutting or forming thread geometries in lengths up to seven inches. Special SEMS products include countersunk, nylon and neoprene, terminal washers, Square Cone® washers and Crest Cup™ washers.

Other products include: Sheet Metal Screws, Machine Screws, Tri-Lobular Screws, Custom Screws, Shoulder Screws, Hi-Lo Screws, Thumb Screws & Captive Screws. 

**Products  
that Perform...**

# RUMCO

### Standards to customs – we've got what you need!

2-, 3- & 4-Piece SEMS	<u>Blank:</u> 00 - 1/2 diameter
Sheet Metal Screws	Metric: M2.5 - M12
Machine Screws	<u>Lengths:</u> Up to 7 inches available
Tri-Lobular Screws	<u>Materials:</u>
Custom Screws	CDA 651 Silicon Bronze
Shoulder Screws	260-270 Brass
Hi-Lo Screws	Low Carbon 1010-1022
Thumb Screws	Medium Carbon 1038, 10B21
Captive Screws	Steel Alloys 4037, 4140 Stainless Steel 18-8 (302), 410, 316, 430



ISO 9001:2008  
QSLM CLASS 2 & 3  
RoHS  
DFARS

**Slotting ■ Rolling**  
**SEMS Rolling ■ Shank Slotting**  
**Trimming ■ Heading**  
**Multi-Blow Transfer Headers**



### Rumco Fastener Division

989 Pauly Drive, Elk Grove Village, IL 60007

Ph 800.537.8626 ■ Fx 847.364.4104

[www.mw-ind.com/divisions/rumco.html](http://www.mw-ind.com/divisions/rumco.html)

**IF YOU REALLY TRUST THE WAREHOUSE - PART 2 OF 2** *continued from page 10*

People need feedback to know how what is expected and how they are performing. Record and post all the data that is accumulated. Initially this will be for the individual and then extended as required to groups of pick/packers and finally warehouse teams. Good natured competition and fairly distributed prizes (not just to the top producers but also for the most improvement) will foster a more cooperative atmosphere. With job rotation every individual has a chance to demonstrate what they can achieve and ideally share what they have learned.

Keep the information/statistics separated by the type of picking, i.e. full warehouse vs. conveyor, as well as any seasonality or outside factors. Note and explain any anomalies so that everyone fully appreciates what is going on. A night or early morning crew is going to experience fewer interruptions and this measurably helps their output.

Without factoring this into the statistics comparisons with the day crew become meaningless at best and antagonistic at worst.

By taking the personnel into the program a step at a time while providing vital information you can build trust and confidence in the system, but more importantly in the person and team. Statistically sampling the output will help minimize any possible risk and with customer involvement (reporting to the quality assurance individual) there will be an additional element of tracking.

### ***Physical Considerations***

Housekeeping, layout and lighting are obvious starting points. People need to have sufficient light to read and not have to worry about stumbling, tripping and impacting trash, columns and storage equipment. Neat is nice, but precision and order are far better. Having teams clean up adjacent aisles and then critiquing the results is one way to develop consistency and standards that fit your context. The object is to get the staff to look for improvements not just walk around the building.

Getting stocking under control will make

implementing pick/pack far easier and eliminate initial quality issues. While training alone can improve both procedures and accuracy there are some simple and relatively inexpensive tools that can easily enhance this function.

Bar code labels need to be implemented to fully support any warehouse improvement program. Item Number and Description should be placed in standard locations on master cases (side) and inners (top flap) if you have control of packaging or repackaging. Standardized labeling positions on the product should also take into consideration carton placement on pallets or in the warehouse. Select the most prominent side or use a wrap around label on the carton corner to guarantee readability.

Ideally to insure that the products are being stocked in the right locations bar code labels incorporating item number and description should be placed on the rear of the flow racks and on the front. Similarly shelves and pallet rack beams should be labeled to create a uniform numbering system throughout the warehouse. Changing colors, borders and special notes can be used to convey item specific information such as "Do not ship this item without all the components."

Taking this to a higher level means purchasing appropriate readers or smart phone "apps" that are compatible with the bar codes. Add simple programming for matching bar codes on racks/shelving/flow racks with the ones on the products and stockers then have a tool for immediate verification of accuracy without the expense of an online, real time Wi-Fi link. Incorporating the same bar codes on paper documents can also be used to insure accuracy.

All these changes can also set the stage for implementing a more sophisticated WMS and can gain perhaps 60% to 90% of the benefits before making any substantial software investments. It will take at least 2 months for any bar code label program to be usable so starting on this in the near future is imperative and it has never been easier.

**No matter how well designed and intentioned a quality based effort ultimately success comes from the people involved.**

ENVIRONMENT

CUSTOMER SERVICE

ON-TIME DELIVERY

VALUE

Don't let **QUALITY** be the missing piece to your puzzle



**Aztech Locknut Company**

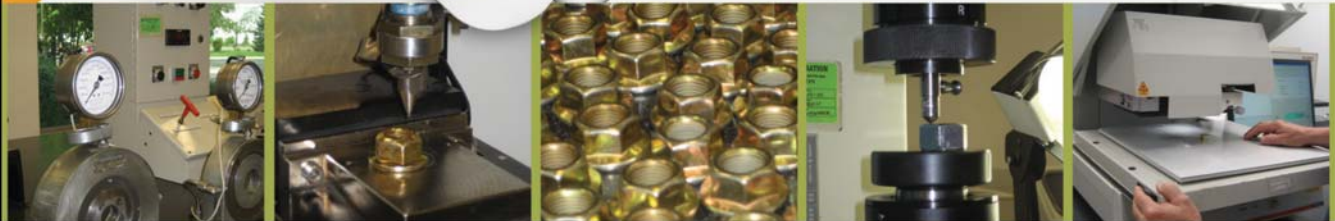

Phone 800-321-5625 | Fax 630-236-3210  
[www.aztechlocknut.com](http://www.aztechlocknut.com)



AS 9100C  
 9001:2008  
 14001:2004



**FASTENERS**

LEONARD

*"Here's something important... The Distributor's Link Magazine will print in their news section, FREE of charge, any new products, services, promotions or company expansion plans, etc.... I say we contact them immediately!"*

**IF YOU REALLY TRUST THE WAREHOUSE - PART 2 OF 2** *continued from page 172*

People need feedback to know how what is expected and how they are performing. Record and post all the data that is accumulated. Initially this will be for the individual and then extended as required to groups of pick/packers and finally warehouse teams. Good natured competition and fairly distributed prizes (not just to the top producers but also for the most improvement) will foster a more cooperative atmosphere. With job rotation every individual has a chance to demonstrate what they can achieve and ideally share what they have learned.

Keep the information/statistics separated by the type of picking, i.e. full warehouse vs. conveyor, as well as any seasonality or outside factors. Note and explain any anomalies so that everyone fully appreciates what is going on. A night or early morning crew is going to experience fewer interruptions and this measurably helps their output.

Without factoring this into the statistics comparisons with the day crew become meaningless at best and antagonistic at worst.

By taking the personnel into the program a step at a time while providing vital information you can build trust and confidence in the system, but more importantly in the person and team. Statistically sampling the output will help minimize any possible risk and with customer involvement (reporting to the quality assurance individual) there will be an additional element of tracking.

### ***Physical Considerations***

Housekeeping, layout and lighting are obvious starting points. People need to have sufficient light to read and not have to worry about stumbling, tripping and impacting trash, columns and storage equipment. Neat is nice, but precision and order are far better. Having teams clean up adjacent aisles and then critiquing the results is one way to develop consistency and standards that fit your context. The object is to get the staff to look for improvements not just walk around the building.

Getting stocking under control will make

implementing pick/pack far easier and eliminate initial quality issues. While training alone can improve both procedures and accuracy there are some simple and relatively inexpensive tools that can easily enhance this function.

Bar code labels need to be implemented to fully support any warehouse improvement program. Item Number and Description should be placed in standard locations on master cases (side) and inners (top flap) if you have control of packaging or repackaging. Standardized labeling positions on the product should also take into consideration carton placement on pallets or in the warehouse. Select the most prominent side or use a wrap around label on the carton corner to guarantee readability.

Ideally to insure that the products are being stocked in the right locations bar code labels incorporating item number and description should be placed on the rear of the flow racks and on the front. Similarly shelves and pallet rack beams should be labeled to create a uniform numbering system throughout the warehouse. Changing colors, borders and special notes can be used to convey item specific information such as "Do not ship this item without all the components."

Taking this to a higher level means purchasing appropriate readers or smart phone "apps" that are compatible with the bar codes. Add simple programming for matching bar codes on racks/shelving/flow racks with the ones on the products and stockers then have a tool for immediate verification of accuracy without the expense of an online, real time Wi-Fi link. Incorporating the same bar codes on paper documents can also be used to insure accuracy.

All these changes can also set the stage for implementing a more sophisticated WMS and can gain perhaps 60% to 90% of the benefits before making any substantial software investments. It will take at least 2 months for any bar code label program to be usable so starting on this in the near future is imperative and it has never been easier.

**No matter how well designed and intentioned a quality based effort ultimately success comes from the people involved.**

# Tired of Getting Only Leftovers?

**POWERS ALWAYS SERVES UP THE HIGHEST QUALITY FASTENERS.**

Ever notice the quality of the products that are being served up by your local importer or repackager? How often do you find yourself wondering what your customers are going to think about the products that you are currently offering? Will they come back or find someone who serves them firsts rather than leftovers. If you worry about how your customers perceive you as a supplier, worry no more!

With Powers line of packaged

fasteners, you can expect to receive the highest quality of product shipped to you on every delivery. No leftovers, no overruns, or products that just don't meet the grade.

When you're looking for quality, Powers is the obvious choice. Call to see how you can get on the packaged fastener program from Powers.



**Powers**  
FASTENING INNOVATIONS

Powers Fasteners, Inc.  
2 Powers Lane  
Brewster, NY 10509  
P: (914) 235-6300  
F: (914) 576-6483  
www.powers.com

**IF YOU REALLY TRUST THE WAREHOUSE - PART 2 OF 2** *continued from page 174*

Accumulating these with periodic picking timed to meet the shipping schedule requires a leap of faith and knowledge of achievable output. Pulling even 100 orders at a time requires putting them in warehouse sequence manually or using a WMS program. This technique is available to any Fastener Distributor who trusts their warehouse crew and usually saves 70% to 80% of the time and effort required for order fulfillment. Obviously with the orders picked and packed on the fly the "order finishing" requirements are also radically diminished, especially if shipping labels can be provided to the pick/packer or printed on the cart.

At the opposite end of the batch size spectrum any orders going to one customer should also be fulfilled using batch pick/pack techniques. For customers who order multiple times per day this means holding all the orders for a timed release with confidence that shipping schedules will be met. For most operations 40 to 50 individual lines in a batch is about the most that can be handled manually by shuffling paper documents. Computer directed operations are limited only by the quantity of materials that the transport cart can hold. Regardless of whether the orders are for one customer (a little lower risk) or for multiple customers one trip through the zone or warehouse should complete every order without back tracking or wasted movements.

Where weigh counting is required this too is done on the fly. Boxes, bins and totes are removed from the shelf at the point of picking, weighed and immediately returned to the stock position. If a container is emptied, turning it upside down signals the stockers that replenishment is required. Noting this manually or with an online report can trigger a systematic batch restocking effort or alert the stockers to do the job whenever they are nearby. This saves even more steps with minimal training and management intervention.

Full carts of prepacked materials are exchanged for empty carts at the "Order Finishing Station." Transferring the tool tote and replenishing the carton supply should take only seconds and the pick/packer can go onto the next batch while their picked orders have flyers, dunnage and paperwork added before being weighed (if necessary) and routed. One finisher should easily handle the output from 5 or more pick/packers.

The ratio goes even higher with semi-automated taping equipment and some inexpensive roller or skate wheel conveyor. Under these circumstances it is not unusual to have 10' or more of output conveyor to accumulate orders prior to staging sortation by route or carrier. As timing becomes more stable and trustworthy the same conveyor can even be used for batch receiving or UPS, USPS and FedEx orders in the morning with order finishing in the afternoon. Many Internet Distributors (and other) use an extension conveyor directly into the carrier's truck or trailer to further minimize travel and handling.

The net result will be labor savings (generally through attrition), better quality and reliability. Predictable timing translates into always fulfilling the promises made to customers and more time for performing the support functions that keep the warehouse running smoothly. People who cannot "get the program" generally leave of their own accord, "flunk out," or are moved into other functions better suited to their potential.

**Everyone wants more money, but job satisfaction, pride and recognition are the best motivators in a recessionary economy.**

### *Incentives*

The long range goal would be an incentive based payment system that shares the savings being generated by the pick/pack improvements with everyone in the warehouse. But one should never mess with people's paychecks until everyone in the company has reached a very high level of trust. Everyone must be on board with this and that won't happen is less than a year in even the best operation.

What one can immediately implement are incentives such as ice cream, pizza, candy or cookies to take home, etc. as goals are met and exceeded. Public recognition and endorsements as skill sets are mastered cost little and go a long way towards building trust. This is another feedback mechanism that lets the people know how they are doing when measured against both their peers and their previous methods. It also insures that management is fully aware of the program success and on top of any changes that should be implemented. Feedback works for everyone.

Everyone wants more money, but job satisfaction, pride and recognition are the best motivators in a recessionary economy. This is how trust is built and how the right atmosphere, philosophies, tools and techniques can come together to create synergies that ultimately generate far more income for both the company and the individuals most involved in satisfying the customers. ○

## DISTRIBUTOR NEWS

**Powers Fasteners, inc.**, placed 1st out of 84 preferred suppliers in distributor member voting for 2011 Vendor of the Year at SPHERE 1 - a cooperative of independent tool and fastener distributors. Their annual member meeting in was held in Las Vegas on May 7th-10th at Red Rock Resort.

"Due to the fact that this particular piece of the ballot is the only component that the distributor has a vote on, we obviously take it very seriously. Finishing 1st in Member Voting tells us that we are doing the right things on a day-to-day basis. We will continue to provide best in class support through our sales and field engineering representatives as well as keep our momentum going by offering a continuous stream of new, innovative fastening solutions" said Lenny Colasuonno, V.P. Sales and Marketing. "We would like to thank the Sphere 1 membership for recognizing our efforts with this vote of confidence".

For more information, to arrange a free demonstration or to find the nearest authorized Powers Fasteners distributor, call our toll free number at 1-800-524-3244, or you can visit us on the internet at [www.powers.com](http://www.powers.com).

## QUALITY, VALUE & SERVICE THERE IS NO SUBSTITUTE

**The Best Source  
For Quality  
Fastener Storage  
Products**

**Supporting  
Distribution  
Since 1945**

**Quick Order Fill  
In Stock & Ready  
To Ship**

**Proudly Made  
In The U.S.A.**



**CRAFTLINE™**  
STORAGE SYSTEMS

[www.craftline.us](http://www.craftline.us) 800-505-9099 [www.plattlabonia.com](http://www.plattlabonia.com)

Visit Us At  
Booth # 241  
NIFS

## DISTRIBUTOR NEWS

New from **Craftline Storage Systems** is their 8 drawer heavy duty service tray compartment box rack cabinet. Drawers are equipped with ball bearing drawer slides and solid drawer bottoms for maximum support and a smooth quiet tool box type slide. Each drawer will support 100 lbs. for a total weight handling capacity of 800 lbs. The cabinet measures 20.5"W x 12.5"D x 30"H and is designed to be used with



locking system are also available. Cabinet is shown with Craftline's heavy duty lockable service tray boxes and heavy duty 6" high base.(service trays and base not included). Available in a Black Textured or Gray powder coat finish. Made in the U.S.A.

To find out more information contact Craftline Storage System at 70

Stoddard Avenue, North Haven, CT 06473. Tel: 1-800-505-9099, Fax 203-234-7978. Email them at [sales@craftline.us](mailto:sales@craftline.us) or visit their website at [www.craftline.us](http://www.craftline.us) or [www.plattlabonia.com](http://www.plattlabonia.com).

**NATIONAL INDUSTRIAL FASTENER & MILL SUPPLY EXPO****VEGAS FASTENER EXPO ROARS PAST 700 EXHIBIT SPACES: LARGE TURNOUT EXPECTED** *continued from 76*34 North High Street • New Albany, OH 43054 • Phone 614-895-1279 • Fax 614-895-3466 • [www.fastenershow.com](http://www.fastenershow.com)

managers and staff are encouraged to attend. Arranging sales agreements, contracts, managing cash flow, assessing sales risk while extending open account credit to customers has never been more challenging. Learn about all this and more (including companies payment habits of those purchasing from fastener industry suppliers) during open discussions. There is no charge for attending this meeting for anyone wearing their 2012 Expo badge. To register and/or for more information contact Darryl Rowinski, President of BCMA at (262) 827-2880 Ext 222 or email [darrylr@wacredit.org](mailto:darrylr@wacredit.org).

**Welcome Reception**

Get ready for the granddaddy of them all! Join the fun from 6:00 p.m. to 7:00 p.m. Wednesday evening, October 10th in the Nevada Ballroom at Harrah's Las Vegas as Expo Management presents the biggest and best party of the year to launch "North America's Largest Fastener Expo". This always popular and well attended event continues to be the fastener industry's most anticipated gathering place annually. With an array of tasty appetizers, inviting drinks and good times, who could ask for more! The Welcome Reception is a great setting to get together with old friends and colleagues as well as form new relationships. It is "Networking Central". The event is complimentary for all Expo exhibitors and attendees wearing their 2012 Expo badge.

**North America's Largest Fastener Expo**

The exhibition will be open from 9:00 a.m. to 4:00 p.m., Thursday, October 11 and from 9:00 a.m. until 1:00 p.m., Friday, October 12. Expo registration fees are \$40 until August 26, \$50 after August 26 and \$60 onsite. The Wednesday evening Welcome Reception is free for all Expo exhibitors and attendees wearing their badge.

**Expo Hotels**

The Venetian/The Palazzo are the Official Headquarters hotels, however, the Expo's original room block has been sold out and rooms are now being

offered on a space and rate availability basis only.

You can reserve rooms by going online to [www.fastenershow.com/hotels/](http://www.fastenershow.com/hotels/) or by calling 877-283-6423 and using the special code listed on the website.

Harrah's Las Vegas is an Official Expo partner hotel and is offering rates guaranteed to be 10% lower than Harrah's online rates. Register online at [www.fastenershow.com/hotels/](http://www.fastenershow.com/hotels/) or by calling 800-214-9110 and using the special code listed on the website. Harrah's is also the site of the Expo's Welcome Reception on Wednesday evening, October 10 and conveniently located a short walk from the Sands Expo Center.

The Flamingo is another Expo partner hotel and is offering rates guaranteed to be 10% lower than Flamingo online rates.

You can register online at [www.fastenershow.com/hotels/](http://www.fastenershow.com/hotels/) or by calling 888-902-9929 and using the special code listed on the website.

**Visit Expo Website for More Information and Planning Expo Visit –**

Expo Management strongly encourages everyone to visit [www.fastenershow.com](http://www.fastenershow.com) to get complete information about the exhibition and conference. Viewers can also see the current exhibitor list, up-to-date exhibit floor plan and much more. Website visitors can also find what they are looking



for by clicking on Exhibitors, then clicking on Groups and locating companies by product category ranging from Abrasives to Wire and everything in between.

**Online Registration**

Convenient, fast and secure online registration for the Expo and all conference sessions is available at [www.fastenershow.com](http://www.fastenershow.com). Expo Management urges everyone to take advantage of advance registration. "It saves Expo visitors both time and money, plus it makes the Expo experience so much easier", says Erin Thomas, Registration Manager.

**For Additional information**

Contact Susan Hurley, General Manager at (614) 895-1279 or email [info@fastenershow.com](mailto:info@fastenershow.com).

*Exhibitor list on page 210*





Tamper-Pruf  
Screws, Inc  
Paramount, Ca

# It's Good in Stock!

Over 100 Million Screws



Call: (562) 531-9340

Fax: (562) 531-2464

TORX and TORXplus Are Registered Trademarks of Camcar Textron

## The Industry Leader in Security Fasteners for over 35 Years

- \* TORX
- \* TORXplus
- \* Security Hex Sockets
- \* DRILLED SPANNERS
- \* CAMCRETE
- \* ONE WAY
- \* Orders received by 4:00PM PST Shipped that day
- \* Available in INCH & METRIC
- \* We stock over 100 million screws
- \* Made in the USA
- \* Complete Manufacturing Facility
- \* Specials-Heading, Thread Rolling- Drilling



Tamper-Pruf  
Screws, Inc  
Paramount, Ca













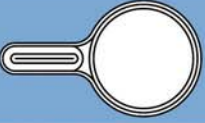











8808 Somerset Blvd. - Paramount, CA 90723

[www.tamperprufscrews.com](http://www.tamperprufscrews.com)  
[tamperpruf90723@sbcglobal.net](mailto:tamperpruf90723@sbcglobal.net)

# MWFA GOLF OUTING AND BANQUET EAGLEWOOD RESORT, ITASCA, IL - JUNE 26, 2012



# shear-LOC<sup>®</sup> QUICK REFERENCE GUIDE

<b>INCH SERIES</b>		<b>KNURLED SERIES</b> MALE THREAD #4 THROUGH 5/16. Available knobs only, assemblies and in kits. This style offers the most common knob for light locking applications.	
		<b>KNURLED SERIES WITH KEY DRIVE</b> MALE THREAD #4 THROUGH 5/16. Available assembled only. This is the same style as the above series but allows for dual hand or hex wrench locking and adjustments.	
		<b>KNURLED SERIES FEMALE THREAD</b> WITH ALUMINUM INSERTS #4 THROUGH 5/16. Available assembled only and in kits. These match the above series for design uniformity.	
		<b>L-SERIES</b> MALE THREAD #10 THROUGH 5/16. Available knobs only, assemblies and in kits. This style is useful in close quarter applications.	
		<b>TEE SERIES</b> MALE THREAD #10 THROUGH 3/8. Available knobs only, assemblies and in kits. This style allows for a little extra torque.	
		<b>ROSETTE SERIES</b> MALE THREAD 1/4 THROUGH 3/8. Available knobs only, assemblies and in kits. This style offers a more decorative look.	
<b>METRIC SERIES</b>		<b>KNURLED SERIES</b> MALE THREAD M3 THROUGH M8. Available knobs only, assemblies and in kits.	
		<b>KNURLED SERIES FEMALE THREAD</b> WITH ALUMINUM INSERTS M3 THROUGH M8. Available assembled only and in kits.	
		<b>TEE SERIES</b> MALE THREAD M5 THROUGH M10. Available knobs only, assemblies and in kits.	
		<b>ROSETTE SERIES</b> MALE THREAD M6 THROUGH M10. Available knobs only, assemblies and in kits. <i><b>NOTE:</b> All knobs for male thumbscrews are cold formed onto standard socket head cap screws.</i>	
<b>LASER</b>	<b>INFO GUIDE SERIES</b> 01  02  03  04  05  06  <b>STANDARD OR CUSTOM</b> Knobs are black acetal resin with white engraving		
	07  08  09  10  11  12  92  98  ?  ?		

**TECHNICAL SUPPORT GO TO WWW.SHEAR-LOC.COM OR CALL 800-775-5668**

US FASTENER DEMAND A BRIGHT SPOT IN THE GLOBAL ECONOMY *continued from page 12***Other stock results include:**

**Wesco Aircraft Holdings** reported revenue grew 5.2% to \$189.3 million in its fiscal third quarter ended June 30, 2012, driven by a 34.5% increase in international sales. Fiscal Q3 net income increased 59% to \$22.3 million. Nine-month revenue gained 6.5% to \$564 million, with net income improving 13% to 465.2 million. On July 3, Wesco acquired fastener distributor Interfast Inc. for CDN\$134 million.

**Carpenter Technology** reported Aerospace & Defense market sales, including fastener material, rose 49% to \$293.9 million in the fourth quarter of fiscal 2012. Excluding surcharge revenue, aerospace & defense sales jumped 55% on 105% higher volume (or up 24% on 21% higher volume without Latrobe Specialty Metals). "Demand for titanium fastener material grew again in the quarter and is now well above prior peak levels. Nickel and stainless fastener demand has led to eight straight quarters of year-over-year growth and is approaching prior peak levels."

**Barnes Group** reported revenue, including fasteners, decreased 2% to \$293.4 million. Organic sales rose 1% in the quarter, offset by a 3% negative impact from foreign exchange. Income from continuing operations for the second quarter grew 9% to \$24.8 million. Q2 orders increased 17% to a record backlog of \$642 million. Overall revenue during the first six months of 2012 gained 1.5% to \$596.5 million, with operating income up 4.1% to \$67.1 million.

**Precision Castparts Corp.** reported Fastener Products sales increased 42% to \$492.8 million in the first quarter of fiscal 2012, which included a full quarter of Primus and a partial quarter of sales from Centra. Segment operating income rose 37% to \$146.2 million, or 29.7% of sales.

Fastener Products orders for the 787 program are gradually aligning with build rates, PCC stated. "Base critical aerospace fastener sales showed more than 15% growth year over year due to base aircraft production increases, slowly improving 787 orders, and heightened distribution activity, and the segment's aerostructures businesses, including the newer acquisitions, are seeing steady top-line improvement as well," the company stated. "Operationally, the base aerospace fastener businesses are starting to drop through solid

incremental margins as larger volumes are leveraged across much improved cost structures."

**Vossloh** reported Fastening Systems revenue dropped 17.5% to EUR 114.3 million during the first six months of 2012, hampered by "project delays in China and the related sales shrinkage." In June, shipments resumed in China, contributing a sales gain of 3% to EUR 74.9 million in the second quarter. First-half order influx by the Fastening Systems segment fell 24% to EUR 143.2 million, though major new contracts were booked in Germany and Thailand during Q2.

**ITW** reported total revenues grew 0.9% to \$4.65 billion in the second quarter of 2012, hindered by negative currency translation. Operating income gained 8.3% to \$770 million. Six-month revenue grew 3.5% to \$9.2 billion, with operating income improving 7.7% to \$1.47 billion.

**B/E Aerospace** reported revenue at its Consumables management segment (CMS) — primarily fasteners — climbed 19.5% to \$286.6 million in the second quarter, with operating earnings rising 14.9% to \$55.5 million. The second-quarter CMS growth rate slowed a bit from the 24.3% rate of growth recorded in Q1. Six-month consumables revenue increased 21.8% to \$573.4 million, with operating earnings gaining 15.5% to \$107.3 million.

**EU Launches Stainless Steel Fastener Circumvention Investigation**

The European Commission initiated an investigation of possible circumvention of antidumping measures on imports of stainless steel fasteners originating in China via Malaysia, Thailand and the Philippines, Fastener + Fixing Magazine reports.

Initiated on the EC's own initiative, the investigation commenced June 24, 2012.

"The Commission says it has prima facie evidence that antidumping tariffs on stainless steel fasteners are being circumvented by means of transshipment via Malaysia, Thailand and the Philippines," writes Fastener + Fixing editor Phil Matten. 

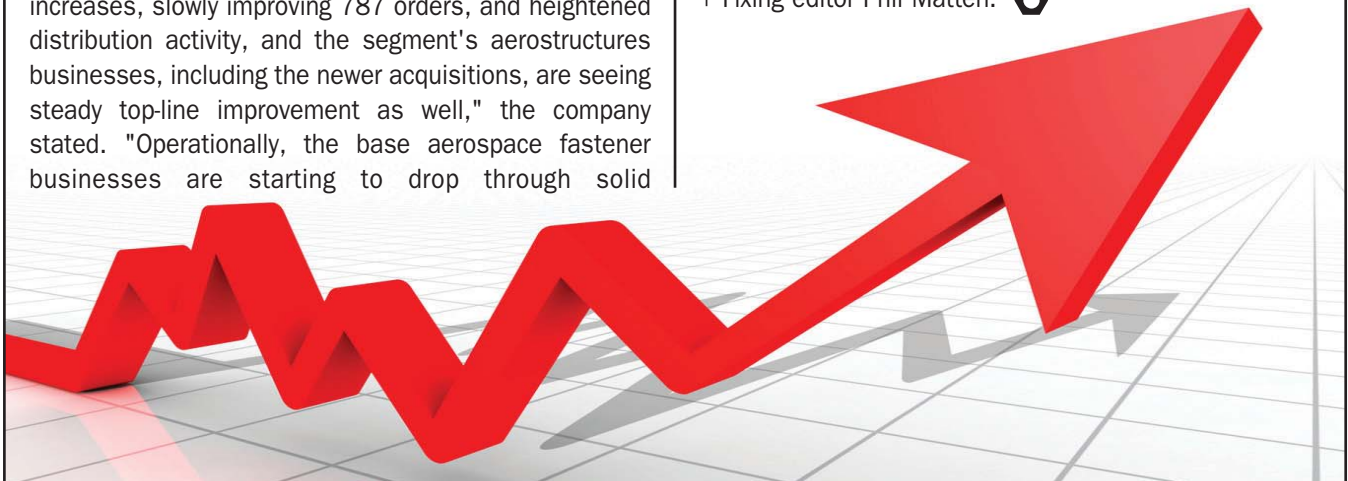

# OSSCO

## BOLT & SCREW CO.

1351 Elmwood Ave.  
Cranston, RI 02910  
FAX (401) 461-6970  
Email: sales@osscobolt.com

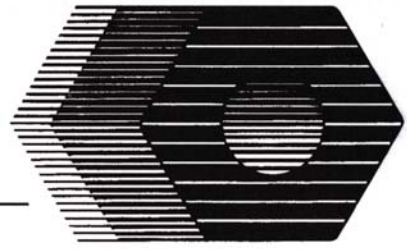

Just Arrived!  
Special: Left Hand  
Finish & Jam Nuts



\* \$25.00 minimum order

Castellated Nuts  
Slotted Nuts  
Hi-Nuts  
Square Nuts  
Left Hand Nuts  
Left Hand Jam Nuts  
Gr. C. Prevailing Torque  
Flange Nuts  
Slip-on Locknuts

Centerlock Nuts  
Nylon Insert Lock Nuts  
Thin Nylon Insert Lock Nuts  
K-Loc  
Wing Nuts (Forged)  
Acorn Nuts  
2H Nuts  
Machine Nuts

Finished Nuts  
Gr. 8 Nuts  
Tee Nuts  
Galvanized Nuts  
DIN 934-Finished Nuts  
DIN 985-Nylon Stop Nuts  
DIN 980-Prevailing Torque  
Acme Nuts

Coupling Nuts  
Cotter Pins  
Gr. 8 Lock Washers  
Gr. 8 Flat Washers  
Fender Washers  
Toggle Wings  
Toggle Bolts  
Plastic Anchors



**Call 1-800-FOR-A-NUT**  
**1-800-367-2688**

NEFDA - 30 Hedgerow, Wethersfield, CT 06107 • Tel: 860.529.4539 • Email: jfs3@cox.net • www.nefda.com

### NEW ENGLAND FASTENER DISTRIBUTORS ASSOCIATION

#### NEFDA 2012 SCHOLARSHIP GOLF OUTING *continued from 158*

Thanks to these Premium Sponsors who provide their substantial support year after year.

Here is the full list of sponsors, without which, the success of the outing would be limited:

#### Golf Outing Sponsors

All-Tech Specialty Fasteners, LLC  
American Fasteners & Components  
Arnold Supply  
Atlantic Fasteners  
B & B Threaded Components  
Brighton-Best International  
Callahan & Moynihan Associates  
Crescent Manufacturing  
Delta Secondary  
Distribution One, Inc.  
Distributor's Link, Inc.  
Eckart & Finard  
Electronic Fasteners  
EZ Sockets  
Fall River Manufacturing  
Ford Fasteners  
Holbrook Mfg. Inc.  
Holo-Krome Fasteners  
Industrial Rivet & Fastener Co.  
John Phalen Associates

Kanebridge Corporation  
Lehigh Armstrong  
Richard Manno & Co.  
McCormick Associates  
Metric Fasteners Corp.  
ND Industries  
NEFCO Corp.  
Northeast Fasteners Co., Inc.  
North East Fasteners Corp.  
Nylok  
Pilgrim Screw Corp.  
Production Fasteners  
Rotor Clip Co.  
Safety Socket  
Screws Industries  
Sems & Specials, Inc.  
Smith Associates  
Solution Industries  
Specialty Bolt & Screw  
Star Stainless Screw Co.  
Stelfast Inc.  
The Coating House  
Tower Fasteners Co., Inc.  
XL Screw Corporation  
Yellow Woods and Roads Less Traveled Co. 



# FASTENER INDUSTRY WEBSITE DIRECTORY

For easy access to all of these websites, log on to [www.linkmagazine.com](http://www.linkmagazine.com) and click on the ad of your choice for a direct hot LINK!

 **ABBOTT-INTERFAST CORP.**  
 NYLON INSERT STOPNUTS  
[www.abbott-interfast.com](http://www.abbott-interfast.com)  
 email: [sales@abbott-interfast.com](mailto:sales@abbott-interfast.com)  
 Phone 847-777-3030 • Fax 847-459-4076

**ABLE LABEL SYSTEMS**  
 LABEL PRINTERS • BARCODE SOFTWARE • FASTENER LABEL SYSTEMS



[www.ablelabelsystems.com](http://www.ablelabelsystems.com)

MADE IN USA   
**Accurate**  
 Manufactured Products Group, Inc.  
 • Sex Bolts • Component Washers  
[www accuratemfg.com](http://www accuratemfg.com)

  
**ACF Components**  
 & Fasteners, Inc.  
[www.acfcom.com](http://www.acfcom.com)  
**1-800-227-2901**

Formed spring steel fasteners  
[www.e-equal-fast.com](http://www.e-equal-fast.com)



  
**Advance Components**  
 The Distributor's Source for Specialty Fasteners  
 [P] 972.446.5500 [F] 972.242.3090  
[advancecomponents.com](http://advancecomponents.com)

  
**Advanced Poly-Packaging, Inc.**  
 Solutions driven approach for bagging fasteners.  
[www.advancedpoly.com](http://www.advancedpoly.com)

**Ajax Wire Specialty Co., Inc.**  
 Think Springs. Think Ajax!  
 800-966-AJAX • Fax: 516-935-2334  
[www.ajaxwire.com](http://www.ajaxwire.com)

 **AKRO-MILS®**  
 OEM Solutions from Akro-Mils!  
 Private Labeling/Rebranding | Kits/Packaging Solutions  
 Display/Merchandising Systems  
[www.akro-mils.com](http://www.akro-mils.com)

 *Albany Steel & Brass Corporation*  
[www.albanysteel.com](http://www.albanysteel.com)  
 from STOCK  
 'B', 'F', 'U', '21', TEKS®, SWAGEFORM®  
 Thumbscrews, Wing Nuts, Screwnails

**YOUR AD HERE!**  
 Claim your FREE Website Ad Listing  
 when you advertise with Link Magazine

**Alcoa Fastening Systems**   
[www.afs-idg.com](http://www.afs-idg.com)

 *The Distributors' Depot*  
[www.alfatools.com](http://www.alfatools.com)

  
 877-865-8237  
[AllAmericanFastenerShow.com](http://AllAmericanFastenerShow.com)

 Quality producers of Washers and Stampings  
 847-566-9091  
[www.allamericanwasherwerks.com](http://www.allamericanwasherwerks.com)

 **ALLOY & STAINLESS FASTENERS**  
[www.GoASF.com](http://www.GoASF.com)

  
 508-520-4005 • Fax 508-520-4185  
[www.agmi.com](http://www.agmi.com)

  
[www.aluminumfastener.com](http://www.aluminumfastener.com)  
 1-800-526-0341

## DISTRIBUTOR NEWS

Having exhibited in every main National Industrial Fastener Show since the very first 1981 show in Columbus, OH, **Delta Engineering** announces that it is pleased to continue its participation for the 32nd consecutive year!

This year we will be in booth 707 and we will be demonstrating our popular Short Run Packaging System Model SRP1.

Follow us on Twitter @FastenerPacking

\* \* \*

Mark Wilcox is the new North American president of **DrillCo Cutting Tools**, owner Chad Mouton announced.

Wilcox was with Sandvik subsidiary Precision Twist Drill (Precision Dormer) in various roles for the past 32 years – including North American president.

"Mark's experience with both the manufacturing and sales sides of the business will be a huge asset to propel DrillCo to the next level," Mouton said. "Mark will be tasked with growing marketing share, creating and executing our marketing strategy, and taking advantage of new market opportunities that exist."

For more information contact DrillCo at 1-800-851-3821, Fax 225-273-9201, or visit the website at [www.drillcocuttingtools.com](http://www.drillcocuttingtools.com).

## Grade 8 No.3 Dome Head Plow Bolts

Zinc Yellow, Zinc Phosphate & Oil, & Plain Finish

This plow bolt features a dome head and is used in a variety of cultivating and plow applications.

Parts are heat treated to SAE J429 Grade 8 specifications.

**170M PSI and raised shoulder bolts too!**



## Grade 8 No.7 Bucket Tooth Plow Bolts

Plain Finish

This plow bolt features a flat, round, countersunk head with a single reverse key that prevents the head from turning.

Also, when replacing bolts, the key insures that the bolt is placed in its original position.

No. 7 Bucket Tooth Plow Bolts are often used on heavy equipment such as snow plows and road graders.

Parts meet SAE J429 Grade 8 specifications.



*"More plow bolts than anyone else in the LCMS."*

**TRINITY HARDWARE HEADQUARTERS**  
PARTS DONE RIGHT.

Email:  
**Sales@TrinityHardwareHQ.com**

Toll free:  
**888.232.1010**  
Fax: **563.441.6760**  
Web:  
**TrinityHardwareHQ.com**

Visit us at the National Industrial Fastener Show, Booth 827  
October 11 - 12, 2012, Las Vegas, Nevada

## DISTRIBUTOR NEWS

**Stafford Manufacturing Corp.** received ISO 9001:2008 certification for its quality management system. "This certification validates the quality values which have guided our company since 1975," founder and president Arthur Stafford said. "Manufacturing has systems in place designed to achieve continual improvement and assure the highest levels of customer

satisfaction."

Stafford manufactures shaft collars and couplings for the OEM and distribution markets.

For more information contact Stafford Manufacturing Corp. at 256 Andover St., Wilmington, MA 01887. Tel: 978-657-8000 or 1-800-695-5551, Fax 978-657-4731. Email: [sales@staffordmfg.com](mailto:sales@staffordmfg.com) or visit them on the web at [www.staffordmfg.com](http://www.staffordmfg.com).

# FASTENER INDUSTRY WEBSITE DIRECTORY

For easy access to all of these websites, log on to [www.linkmagazine.com](http://www.linkmagazine.com) and click on the ad of your choice for a direct hot LINK!

jay@discountscrews.com



**AMERICAN IMPERIAL**

800-431-2391

Over 500 million screws in stock

Quality is Our Key to Success

**ANDROCK**  
Hardware Corporation

[www.androckhardware.com](http://www.androckhardware.com)



Phone 870.453.2343  
Fax 870.568.0811

[www.ark-plas.com](http://www.ark-plas.com)



**ATLANTA ROD & MANUFACTURING COMPANY, INCORPORATED**

[www.ATLROD.COM](http://www.ATLROD.COM)



**AUSTIN**  
HARDWARE & SUPPLY, INC.  
SECURING SOLUTIONS FOR YOUR BUSINESS

[www.austinhardware.com](http://www.austinhardware.com)



"If we don't have it, we'll help you find it."

[www.azliftinghardware.com](http://www.azliftinghardware.com)



**Aztech Locknut Company**

[www.aztechlocknut.com](http://www.aztechlocknut.com)



**BAR STOCK SPECIALTIES, INC.**  
Your Specialty Bar Distributor with Specialty Bar Processing

[www.GoBarStock.com](http://www.GoBarStock.com)

All the Top Riveting & Fastening System Lines Under One Roof



**BAY FASTENING SYSTEMS**

1-800-718-8818  
[www.bayfastening.com](http://www.bayfastening.com)

**BBC Fasteners**

Cold Headed Parts  
Metrics Too!

[www.bbcfasteners.com](http://www.bbcfasteners.com)



**Beacon**  
FASTENERS AND COMPONENTS, INC.

HIGH-LOW TAPPING | SHEET METAL | SEMS | THREAD CUTTING | THREAD FORMING

AND NEW MACHINE SCREWS!

800-669-2658 | [www.beaconfasteners.com](http://www.beaconfasteners.com)



**beta**  
steel group

[www.betasteel.com](http://www.betasteel.com)



**BIG RED FASTENERS**

[www.bigredfasteners.com](http://www.bigredfasteners.com)



**BRIGHTON-BEST INTERNATIONAL**

Master Distributor / Importer for all your fastener needs  
BEST Quality, Service, Value Since 1925

800-275-0050  
[www.brightonBEST.com](http://www.brightonBEST.com)



**BRITISH METRICS**  
A DIVISION OF SCOTTISH IMPORTS LTD.

Metric & British Hardware  
[www.britishmetrics.com](http://www.britishmetrics.com)



**CABLE TIE EXPRESS**  
Tying Service to Quality

[www.cabletieexpress.com](http://www.cabletieexpress.com)



**Capital Marketing**

Sales and Marketing from a Premier Agency

[www.capital-marketing.com](http://www.capital-marketing.com)



**CARDINAL FASTENER**

[www.cardinalfastener.com](http://www.cardinalfastener.com)



**CAV CAVALIER**  
Industrial Specialties

[www.GoCAV.com](http://www.GoCAV.com)

• Steel Forgings • Wire Forms



**Chicago Hardware & Fixture Company**

[www.chicagohardware.com](http://www.chicagohardware.com)



**CHRISLYNN**  
HELICAL INSERTS  
PRECISION

Professional Thread Repair Kits  
800-926-1495  
[www.chrislynninserts.com](http://www.chrislynninserts.com)



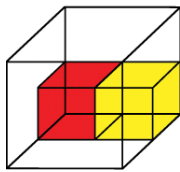

**QUANTUM<sup>®</sup>  
STORAGE  
SYSTEMS**

**Quantum Storage Systems**

15800 NW 15th Avenue, Miami, FL 33169

Tel: 1-800-685-4665 or 305-687-0405

Email: sales@quantumstorage.com

www.quantumstorage.com

## AN INDUSTRY FIRST... FROM QUANTUM STORAGE SOLUTIONS

Quantum Storage Systems is the Nation's leading manufacturer and supplier of bins, bin storage systems and wire shelving. Headquartered in Miami, Quantum boasts the largest inventory of heavy-duty plastic bins, steel and wire shelving, and storage containers. Product offering features many storage innovations including the unique Rackbin™ series of extra large, 42" long, heavy-duty poly bins designed specifically for pallet rack. Quantum provides its customers with many top-quality products, manufactured in the U.S.A., at great prices, and in stock for quick delivery. Quantum is the single-source solution provider for your sorting, organizing, and transporting needs. Sold through a nationwide network of distributors.

Quantum recently announced its new line of Stackable Shelf Bins. These durable polypropylene bins



feature sizes that are an industry first! They combine all the features of Quantum's Ultra Stack and Hang Bins with their Economy Shelf Bins to create a unique, economical solution for storing medium or large, heavy, and bulky items. They have a built-in rear hanger which allows the bin to hang from louvered panels and rails. The bin's raised front opening allows the user to truly maximize the complete bin's storage capacity. Optional cross dividers allow flexibility and keep parts organized.

Waterproof bins resist rust and corrosion.

Available in black, blue, gray, ivory, and orange, the bins are offered in many sizes, are autoclavable, and resistant to extreme cold. They are manufactured in the U.S.A. and are IN STOCK for immediate shipping from the company's nationwide distribution centers. Great storage products, delivered quickly at the guaranteed lowest prices – Quantum! 

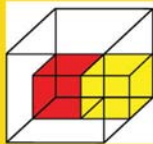

**QUANTUM<sup>®</sup>  
STORAGE  
SYSTEMS**

**GUARANTEED  
LOWEST PRICES**

- Your Preferred Supplier of Bins and Bin Storage Systems!
- In Stock for Immediate Delivery!
- Nationwide Shipping: Miami, Chicago, Philadelphia, Los Angeles.



THE LARGEST SELECTION OF PLASTIC BINS,  
STEEL & WIRE SHELVING AND COMPLETE BIN SYSTEMS

800-685-4665

www.quantumstorage.com

# FASTENER INDUSTRY WEBSITE DIRECTORY

For easy access to all of these websites, log on to [www.linkmagazine.com](http://www.linkmagazine.com) and click on the ad of your choice for a direct hot LINK!



**COMPONENT PACKAGING**  
*Whatever It Takes!*  
[www.componentpackaging.com](http://www.componentpackaging.com)



**Computer Insights, Inc**  
[www.ci-inc.com](http://www.ci-inc.com)  
simple • focused • effective



**Critical Care Fasteners**  
[www.copperstate.com](http://www.copperstate.com)

**Couplings Company, Inc.**  
Please visit our website at:  
[www.brassfittings.com](http://www.brassfittings.com)



**BRASS FITTINGS** WE'LL BE YOUR WAREHOUSE!



**CRAFTLINE**  
Storage Systems  
sales@craftline.us  
[www.craftline.us](http://www.craftline.us)



**CRESCENT MANUFACTURING**  
**PROUDLY MADE IN THE USA**  
[www.crescentmanufacturing.com](http://www.crescentmanufacturing.com)

**CTG International**  
*Your Mill Direct Fastener Source*  
[www.ctgintl.com](http://www.ctgintl.com)  
email: ctgintl@ctgintl.com

**CURTIS**  
*Metal Finishing Company*  
Sterling Heights, Michigan • Machesney Park, Illinois  
Contact Brian Lowry @ (586) 939-2850 or brian@curtismetal.com  
[info@ZnCoat.com](mailto:info@ZnCoat.com) [ZnCoat.com](http://ZnCoat.com)

**The Dale Company**  
[www.dalecompany.com](http://www.dalecompany.com)

**DARLING DB BOLT CO.**  
[www.darlingbolt.com](http://www.darlingbolt.com)  
E-mail: sales@darlingbolt.com



**DDI SYSTEM**  
Distribution Software  
[www.ddisys.com](http://www.ddisys.com)



**DELTA**  
Delta Engineering LLC  
[www.deltaengineeringcorp.com](http://www.deltaengineeringcorp.com)

**Detroit Washers & Specials**  
[www.detroitwasher.com](http://www.detroitwasher.com)



**DISTRIBUTION One**  
Distribution Software for Wholesale Distributors  
[www.distone.com](http://www.distone.com)



**divspec**  
an Edwards & West Company  
[www.divspec.com](http://www.divspec.com)



**DRILLCO**  
The Home of the Nitro  
[www.drillcocuttingtools.com](http://www.drillcocuttingtools.com)

**DuPage products group**  
[www.dupageproducts.com](http://www.dupageproducts.com)

**DURHAM MFG**  
Est. 1922  
[www.durhammfg.com](http://www.durhammfg.com)  
1-800-243-3774



**DYSON**  
Domestic Fasteners and Forgings Since 1884  
[www.dysoncorp.com](http://www.dysoncorp.com)



**E&A PRODUCTS INCORPORATED**  
Manufacturing Construction, Mil-Spec, OEM Fasteners for over 30 years!  
1-800-711-0830 [Sales@EA-Products.com](mailto:Sales@EA-Products.com)  
[www.EA-Products.com](http://www.EA-Products.com)



**Eastwood Manufacturing**  
*Specials and Non-Standards*  
[www.boltman.com](http://www.boltman.com)

# HUCK

®

**ONE OF THE STRONGEST LINES  
YOU CAN ADD TO YOUR BOTTOM LINE.**

Find out how.

Alcoa  
Fastening  
Systems



[AFSindustrial.com/distribution](http://AFSindustrial.com/distribution)

**HUCK**

®



# FASTENER INDUSTRY WEBSITE DIRECTORY

For easy access to all of these websites, log on to [www.linkmagazine.com](http://www.linkmagazine.com) and click on the ad of your choice for a direct hot LINK!



**Elgin Fastener Group**  
www.elginfasteners.com



Wire Rope, Cable, Chain & Hardware  
1-800-458-6659  
www.elitesalesinc.com

**Empire Fasteners, Inc.**  
Drilled Fillister Specialists  
800-598-5212  
www.EmpireFastenersInc.com



**EUROLINK™**  
FASTENER SUPPLY SERVICE  
YOUR SOURCE FOR HARD-TO-FIND METRIC FASTENERS  
866-787-7594  
www.eurolinkfss.com  
*Hard To Find. Delivered.*



Visit our website today. Complete list of Thread Inserts/sizes, repair kits. Request free samples-catalog.  
www.ezlok.com

**E Z Sockets, Inc.**  
800-631-7833 • Fax 973-376-7130  
e-mail: ezsockets@juno.com  
www.ezsockets.com



800-275-6991 / Fax 508-675-8770  
www.FALLRIVERMFG.COM  
Manufacturers of stainless steel and non-ferrous screws bolts and nuts



*"The Good Guys"*  
**Fascomp**  
electronic hardware  
Standoffs Spacers Jackscrews Shoulder Screws Thumb Screws Captive Screws Swages  
(Tel) 407-226-2112 (Fax) 407-226-3370  
www.fascomp.com

For PINS the first choice is:  
**FASTAR**  
888-FASTAR5 • Fax 845-369-7989  
www.fastar.com

**FORD FASTENERS, INC.**  
The #1 source for 410ss screws  
www.fordfasteners.com



**GF&D SYSTEMS**  
www.gfdsystems.com

**GLOBAL FASTENER NEWS.COM**



*"Quality Service for your Quality Department"*

**YOUR AD HERE!**  
Claim your FREE Website Ad Listing when you advertise with Link Magazine

**Hanger Bolt & Stud Co.**  
1-800-537-7925  
www.hangerbolt.com  
e-mail: hbs@hangerbolt.com



**HANSON RIVET & SUPPLY CO.**  
866-61-RIVET (866-617-4838)  
www.hansonrivet.com

**HOLBROOK MFG., INC.**  
Internet www.holbrookinc.com

**Hillsdale Terminal & Tool, Inc.**  
Buy Direct From The Manufacturer  
www.hillsdaleterminal.com

**ICS Flange**  
Quality Customer Service  
1-800-231-0360  
www.innovativecomponentsales.com

**IDEAL FASTENERS INC.**  
www.idealfasteners.com

**IDEAL SUPPLY, INC.**  
Aluminum, Brass, Monel, Silicon Bronze, Stainless, Titanium Fasteners  
Corporate Office: Ph.847-961-5900 Fax 847-961-5300 Email: illidealsupply@aol.com  
Branch Office: Ph. 757-548-8050 Fax 757-548-8051 vaidealsupply@aol.com



4625 13th Street  
Wyandotte, MI 48192



# Wyandotte Industries, Inc.

## Manufacturer of "Blueprint Specials"

*Specializing in non-standard products machined from bar –  
Special threads, Configurations, Dimensions and Tolerances*



### Materials:

- ▼ Low and Medium Carbon Steel
- ▼ Alloy Steel
- ▼ Aluminum
- ▼ Brass
- ▼ Bronze
- ▼ Stainless Steel

### OD Sizes:

#### Round

11/32" to 7"  
8 mm to 178 mm

#### Hex

11/32" to 6"  
8 mm to 152.4 mm

## Dependable Products from a Dependable Company!

Your Complete Source for Special Nuts,  
Locknuts, Screw Machine and CNC Products

TS16949, ISO 9001, AS9100  
and NADCAP Certified

QSLM Class 2 & 3 Threaded Fasteners

Manufacturing low and medium volumes

### SPECIAL NUTS AND LOCKNUTS

All Metal Locknuts  
Bearing Nuts  
Castle Nuts  
Coupling Nuts  
Flange Nuts  
Jam Nuts  
Nylon Insert Locknuts  
Panel Nuts  
Shear Nuts  
Slotted Nuts  
Spanner Nuts  
Stake Nuts  
Weld Nuts  
Wheel Nuts

### SCREW MACHINE AND CNC PRODUCTS

Bushings  
Collars  
Connectors  
Fittings  
Inserts  
Knurled Parts  
Machined Washers  
Pistons  
Spacers  
Threaded Spacers  
Vents

Call us today at (734) 283-1870

visit us at [www.wyandotte.com](http://www.wyandotte.com) • Fax (734) 283-6166

# FASTENER INDUSTRY WEBSITE DIRECTORY

For easy access to all of these websites, log on to [www.linkmagazine.com](http://www.linkmagazine.com) and click on the ad of your choice for a direct hot LINK!

**Imberman and DeForest, Inc.**  
*Consultants to Management*  
**Boost Your Employee Productivity**  
**Grow Your Bottom-Line Profitability**  
[www.imbdef.com](http://www.imbdef.com)    [info@imbdef.com](mailto:info@imbdef.com)

 **IMPERIAL Rivets Fasteners**  
[www.imperialrivet.com](http://www.imperialrivet.com)  
e-mail: [sales@imperialrivet.com](mailto:sales@imperialrivet.com)

 **Industrial Nut Corp.**  
[www.industrialnut.com](http://www.industrialnut.com)

**Industrial Rivet & Fastener Co.**   
**1-800-BUY-RIVET**  
[www.rivet.com](http://www.rivet.com)

  
[www.interfastgroup.com](http://www.interfastgroup.com)

  
INTERCONTINENTAL SALES CORPORATION  
[www.isc-sales.com](http://www.isc-sales.com)

 **inxsql**  
If your business is fasteners...your software should be INxSQL.  
Effective, Affordable, Efficient  
[www.inxsql.com](http://www.inxsql.com) • 877.446.9775

  
**J.T.D. STAMPING CO., Inc.**  
[www.jtdstamping.com](http://www.jtdstamping.com)

 **Jay-See Sales & Rivet Inc.**  
*"The Quality Rivet People"*  
[www.rivetsinstock.com](http://www.rivetsinstock.com)

**KEN FORGING**  
*Leader in the Eyebolt Industry*  
1-888-536-3674 • Fax 440-992-0360  
[www.kenforging.com](http://www.kenforging.com)

 **KEY BELLEVILLES, INC.**  
Tel: 1-800-245-3600  
[www.keybellevilles.com](http://www.keybellevilles.com)  
email: [sales@keybellevilles.com](mailto:sales@keybellevilles.com)

 **Kinter**  
[www.kinter.com](http://www.kinter.com)

 **Knapp Fasteners**  
INCORPORATED  
CELEBRATING 25 YEARS  
[WWW.KNAPPFAST.COM](http://WWW.KNAPPFAST.COM)

 **K-T BOLT**  
MANUFACTURING CO., INC.  
Manufacturing & Forging Since 1969  
HD Capacity 1/2 - 3" dia.  
Threading to 4" dia.  
[www.k-tbolt.com](http://www.k-tbolt.com) • 800-553-4521

 **LELAND**  
INDUSTRIES INC.  
[www.lelandindustries.com](http://www.lelandindustries.com)  
1-800-263-3393

 **LOCKNUT**  
TECHNOLOGY INC.  
[WWW.LOCKNUTTECHNOLOGY.COM](http://WWW.LOCKNUTTECHNOLOGY.COM)

**Lok-Mor, Inc.**  
Locknuts  
Standards and Specials  
[www.lok-mor.com](http://www.lok-mor.com)  
1-800-843-7230

**HAVE YOU SEEN US ONLINE?**  
[www.linkmagazine.com](http://www.linkmagazine.com)

 **LYN-TRON, INC.**  
[www.lyntron.com](http://www.lyntron.com)

**Mehta Trading International**  
*The Complete Stainless Steel Fastener Source*  
[www.Mehtati.com](http://www.Mehtati.com)  
e-mail: [Corp@Mehtati.com](mailto:Corp@Mehtati.com)

 **MFC**  
METRIC FASTENERS CORP.  
[www.metricfastenerscorp.com](http://www.metricfastenerscorp.com)

# I NEED...IT TODAY, OR SOONER.

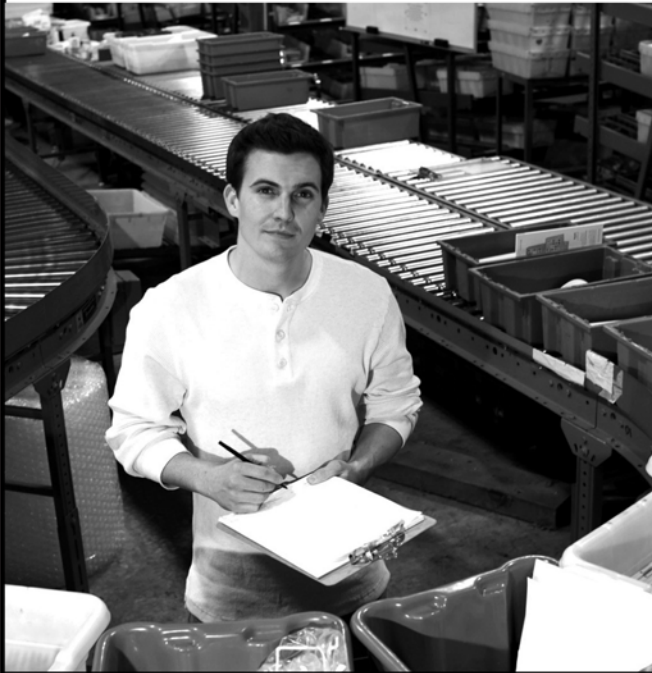

**Austin Hardware is a fastener distributor that knows exactly what you need.**

That's why we stock a huge inventory of standard and specialty engineered fasteners from top brands like Huck, Pop, Avdel, Southco, and more. It's why we offer SAME-DAY SHIPPING for orders placed by 5 PM. And it's why we offer ABLE II, our comprehensive VMI program, for qualifying customers. At Austin Hardware, we put everything we've got into supplying everything you need. Call your nearest Austin Hardware location and let us prove it to you today.

**AUSTIN**  
HARDWARE & SUPPLY, INC.  
SECURING SOLUTIONS FOR YOUR BUSINESS

Good  
Enough  
Never Is.

California: 800.821.3520 | Georgia: 800.821.1664 | Indiana: 800.220.8118 | Missouri: 800.821.3520  
Pennsylvania: 800.634.4293 | Texas: 800.527.5640 | Wisconsin: 800.220.8118 | [www.austinhardware.com](http://www.austinhardware.com)

**Buckley**  
QC Fasteners

*Conversion Specialists of Threaded Fasteners*

BRASS TIP • NYLON TIP • NYLON PELLETT INSERT



- Inch and Metric •
- Standards and Specials •
- Miniatures •
- Prototype and High Volume •
- Complete and Process Only •

Free Samples Available  
for Your Evaluation

YOU Decide It...  
WE Can Provide It

*Buy Quality With Confidence*

3874 California Road, Orchard Park, NY 14127  
Phone 800.344.3874 • 716.662.1490 • Fax 716.662.0669

# FASTENER INDUSTRY WEBSITE DIRECTORY

For easy access to all of these websites, log on to [www.linkmagazine.com](http://www.linkmagazine.com) and click on the ad of your choice for a direct hot LINK!



**Metric & Multistandard Components Corp.**  
Fasteners • Cutting Tools • Measuring Tools  
[www.metricmcc.com](http://www.metricmcc.com)

**micro plastics, inc.**  
Registered to ISO 9002  
Certificate No. A2659  
email: [mpsales@microplastics.com](mailto:mpsales@microplastics.com)  
Web Site: [www.microplastics.com](http://www.microplastics.com)



See the new online magazine at  
[www.linkmagazine.com](http://www.linkmagazine.com)



**MW INDUSTRIES, INC.**  
Manufacturer of custom washers, fasteners & metal stampings.  
[www.mwindustries.com](http://www.mwindustries.com)



**ND INDUSTRIES**  
Advanced Adhesive and Sealant Technologies  
[www.ndindustries.com](http://www.ndindustries.com) • phone: 1-800-471-5000



**NATIONAL THREADED FASTENERS, LTD.**  
[www.flangescrews.com](http://www.flangescrews.com)  
phone: 440.350.1430 | fax: 440.350.1676  
3705 Lane Rd. Perry, OH 44081  
[sales@flangescrews.com](mailto:sales@flangescrews.com)



**Nationwide Packaging Services, Inc.**  
Commercial & Military Packaging Specialists  
[www.nationwidepackaging.com](http://www.nationwidepackaging.com)  
Ph. 973-882-1711 • Fax 973-882-1742

ISO 9001-2008 AS9100 Certified **NEFC** QSLM Level 2/3  
NORTH EAST FASTENERS CORPORATION  
A Tradition of Precision  
[WWW.NEFL.COM](http://WWW.NEFL.COM)  
Telephone: (860) 589-3242 Fax: (860) 589-6969  
8 Tremco Drive, Terryville, CT 06786-0322



**NOVA**  
Complete Stocking Inventory Of All Commercial Fasteners  
[www.novafasteners.com](http://www.novafasteners.com)  
e-mail: [info@novafasteners.com](mailto:info@novafasteners.com)



**NUCOR FASTENER DIVISION**  
P.O. Box 6100 • St. Joe, IN 46785  
Phone (800) 955-6826  
[www.nucor-fastener.com](http://www.nucor-fastener.com)



**PAC FAS**  
Full Line Supplier of Packaged Fasteners & Accessories for Resale Since 1964  
Phone 1-800-444-5834  
[www.pacfas.com](http://www.pacfas.com)



**PACIFIC WAREHOUSE SALES**  
[www.pacificwarehousesales.com](http://www.pacificwarehousesales.com)



**PETERSON SPRING**  
MANUFACTURERS OF ENGINEERED METAL PRODUCTS  
[www.pspring.com](http://www.pspring.com)



**PIVOT POINT**  
Award Winning Non-Threaded Fasteners  
Quick Release Pins, Clevis Pins, Cotter Pins  
[www.pivotpins.com](http://www.pivotpins.com)

**YOUR AD HERE!**  
Claim your FREE Website Ad Listing when you advertise with Link Magazine



**Powers FASTENERS**  
Powers Packaged Fasteners Now Available!  
[www.powers.com](http://www.powers.com)



**PRECISION SPECIALTIES**  
SIMPLY THE BEST FOR OVER 25 YEARS  
★ ★ ★ ★ ★  
★ ★ ★ ★ ★  
★ ★ ★ ★ ★  
CALL 901.854.5640  
[www.precspec.com](http://www.precspec.com)



**PRECISION TECHNOLOGY SUPPLIES**  
Stainless Steel Industrial Fastenings & Precision Turned Parts  
[WWW.PTS-UK.COM](http://WWW.PTS-UK.COM)

**Prestige Stamping, Inc.**  
Phone 586-773-2700  
Fax 586-773-2298  
[www.prestigestamping.com](http://www.prestigestamping.com)



**QUANTUM STORAGE SYSTEMS**  
CLEARLY YOUR SOLUTION FOR STORING FASTENERS  
[www.quantumstorage.com](http://www.quantumstorage.com)



**R&R ENGINEERING CO**  
800-979-1921 • Fax 800-345-9583  
[www.randreengineering.com](http://www.randreengineering.com)



# PAC FAS

Full Line Supplier of Packaged Fasteners & Accessories of All Types and Materials

Your Friendly Neighborhood Backorder Buster!



**FILL YOUR SHORTS**  
1 PHONE CALL + 1 PURCHASE ORDER + 1 FREIGHT BILL  
**= BIG \$AVING\$**

REMEMBER, WE OFFER SAME DAY SHIPPING UNTIL 4PM CST ON UPS



Is it a Goose?...  
Is it a Jet?...  
NO!  
It's Captain Zero!

1509 ALABAMA, SOUTH HOUSTON, TX 77587 | TEL: 1-800-444-5834 | FAX: 1-800-388-8077

**WWW.PACFAS.COM**

PWFA - 10842 Noel Street, #107, Los Alamitos, CA 90720 • Tel: 714.484.4747 • Fax: 562.684.0695 • www.pac-west.org

## PACIFIC-WEST FASTENER ASSOCIATION

**PAC-WEST FALL CONFERENCE: SCOTTSDALE, ARIZONA - NOV 8-10, 2012** continued from 88

- The Business Executive Workshop program will focus on:
1. Gaining a deeper understanding of the impact you are having on the people around you
  2. Understanding the science of the human brain and how that influences behavior
  3. Learning emotionally intelligent techniques to keep it together during difficult times and in challenging relationships
  4. Learning skills to deal with the emotions of others when there is tension and conflict
  5. Practicing emotional intelligence techniques to coach others to higher performance
  6. Developing a plan to connect more deeply with your employees, peers and family

Bobi Seredich will present this session. She is the co-founder of the Southwest Institute for Emotional Intelligence. EI is the ability to manage one's emotions in a healthy and productive manner. It's how we handle ourselves and how we handle our relationships.

### • Ignite Pac-West

Ignite! These are five-minute presentations, accompanied by 20 slides. It's quick, exciting and the objective: educate and make it fun. You can use your five minutes to talk about company initiatives or about

anything that you're passionate about. If you want to Ignite Pac-West, give us a call!

For an example of an Ignite session, see Pac-West executive director Vickie Lester presenting one at the 2011 annual meeting of the American Society of Association Executives at <http://www.youtube.com/watch?v=jMjaHPxb514>

### Social Events

It's important to have fun at conferences too! We'll kick off the conference with a reception generously sponsored by Copper State Bolt and Nut, and one night there will be a western cookout.

Golf is planned on two days, at the McCormick Ranch Golf Club and at the Estancia Club.

Not into golf? Then we have tours of Frank Lloyd Wright's Taliesin West and a hiking and photography excursion, plus, not to forget spouses with an outing to Old Scottsdale.

### Registration

Visit [www.pac-west.org](http://www.pac-west.org) for registration details. There are special rates for members and nonmembers. NFDA members are invited to participate in the conference at the Pac-West member rate. We hope to see you in Scottsdale! 



# FASTENER INDUSTRY WEBSITE DIRECTORY

For easy access to all of these websites, log on to [www.linkmagazine.com](http://www.linkmagazine.com) and click on the ad of your choice for a direct hot LINK!



**RAF ELECTRONIC  
HARDWARE**  
a Division of **MW Industries, Inc**  
[www.rafhdwe.com](http://www.rafhdwe.com)  
203-888-2133 • [info@rafhdwe.com](mailto:info@rafhdwe.com)

*'The Distributor's Distributor!'*



**1-800-RAPIDRT (727-4378)**  
[www.rapidrivet.com](http://www.rapidrivet.com)

**W.J. Roberts Co., Inc.**

Spacers and Standoffs

Phone: 781-233-8176  
[www.wjroberts.com](http://www.wjroberts.com)

**ROTOR CLIP COMPANY, INC.®**  
Retaining Rings • Wave Springs  
Spiral Rings • Hose Clamps



800-557-6867 • 1-732-469-7333  
[www.rotorclip.com](http://www.rotorclip.com) • [sales@rotorclip.com](mailto:sales@rotorclip.com)



[www.mw-ind.com/divisions/rumco](http://www.mw-ind.com/divisions/rumco)



*The Retaining Ring Manufacturer with Integrity*

[www.smretainingrings.com](http://www.smretainingrings.com)



Tamper-resistant screws

[www.screwsupply.com](http://www.screwsupply.com)  
email: [sales@screwsupply.com](mailto:sales@screwsupply.com)

**SEASTROM**

Quality, Experience, Reliability  
Made in the U.S.A.  
[www.seastrom-mfg.com](http://www.seastrom-mfg.com)  
1-800-634-2356

**THE ORIGINAL  
shear-Loc®**



800-775-5668  
[WWW.SHEAR-LOC.COM](http://WWW.SHEAR-LOC.COM)  
OR FAX 949-768-8705



Spiral Retaining Rings  
Wave Springs

Engineering assistance for distributors, 5000 stock parts available in carbon and stainless steel.  
(847) 719-5900 • fax: (847) 719-5999  
[www.smalley.com](http://www.smalley.com) • email: [info@smalley.com](mailto:info@smalley.com)



**SOLON** Phone 800-323-9717  
MANUFACTURING CO. Fax 440-286-9047

Belleville Spring Washers  
Flange Washers  
Disc Springs  
[www.solonmfg.com](http://www.solonmfg.com)



**Solution  
Industries**

[www.solutionind.com](http://www.solutionind.com)

**HAVE YOU  
SEEN US  
ONLINE?**  
[www.linkmagazine.com](http://www.linkmagazine.com)

**Tamper-resistant  
Screws**

**Specialty Screw Mfg.**  
[www.specialtyscrewmfg.com](http://www.specialtyscrewmfg.com)

**SpringFast**

[www.springfastri.com](http://www.springfastri.com)

**SPIROL**

1-800-321-4679  
[www.spirol.com](http://www.spirol.com)



**STELFAST® INC.**  
Manufacturer/Importer  
[www.stelfast.com](http://www.stelfast.com)  
800-729-9779 • Fax 440-879-0044

**SUPERIOR  
BOLT  
& NUT MFG**

[www.superiorbolt.com](http://www.superiorbolt.com)

**SUPERIOR**



WASHER & GASKET CORP.  
[www.superiorwasher.com](http://www.superiorwasher.com)  
E-mail: [swg@superiorwasher.com](mailto:swg@superiorwasher.com)

**SUPPLY  
LINE**



MRO Distributor Supply Warehouse  
[www.usaSupplyLine.com](http://www.usaSupplyLine.com)

**YOUR AD HERE!**

Claim your **FREE Website Ad Listing**  
when you advertise with Link Magazine

## DISTRIBUTOR NEWS

**The Auto Bolt Company** is expanding their capabilities. With the purchase of a 3/4" trimmer, Auto Bolt has the ability to manufacture 3/4" (M20) hex head and square head bolts, up to 4" in length. The new machine is expected to be up and running mid fall 2012.

Auto Bolt would like to welcome Elias Caraballo to their sales team as of May 2012. Elias joined Auto Bolt in 2007, working in the shipping department. His knowledge of the cold forming process and relationship with vendors makes him a valuable asset to the sales team. He also brings bilingual Spanish speaking capabilities which is a huge asset for the Spanish speaking fastener marketplace.

Auto Bolt is a cold-forming manufacturer of bolts, rivets, and pins, specializing in longer lengths and mid to heavy diameters. The company has been doing business since 1948 in Cleveland, Ohio. The company prides itself on exceptional customer service and superior quality.

For further information, contact Auto Bolt at 4619 Perkins Ave., Cleveland, OH 44103. Tel: 1-800-988-BOLT (toll-free) or 216-881-3913; Fax: 216-881-3918 or visit the Autobolt website at [www.autobolt.net](http://www.autobolt.net).

# SPIROL®

[www.spirol.com/s/overview-link/](http://www.spirol.com/s/overview-link/)



## Precision Machined Brass Nuts

○ Superior to cold formed and punched nuts

○ Threads roll freely with no tight spots

○ Threads are manufactured to strict standards with specific gages

○ Clean, burr free, and ready to use



Visit us at  
Booth 522  
National Industrial Fastener  
and Mill Supply Expo  
October 10-12, 2012  
Las Vegas, Nevada USA

**SPIROL.com**

P 800.321.4679  
F 860.774.0487

Over 60 years of manufacturing and application engineering expertise.

## DISTRIBUTOR NEWS

**Elgin Fastener Group** has announced the appointment of Javier Martinez to the position of Director of Information Technology.

Martinez has more than 15 years of experience in the development and execution of information technology solutions for a variety of companies in southeastern Ohio. He holds a B.A. in Computer and Information Technology from Susquehanna



University, a Master of Science in Management Science from the University of Dayton, and a Masters Certificate in IT Project Management from Villanova University. Martinez will report to

EFG Chief Financial Officer Ian McKenna.

Elgin Fastener Group is comprised of seven leading domestic specialty fastener manufacturers (Ohio Rod Products, Leland Powell Fasteners, Chandler Products, Quality Bolt & Screw, Silo Fasteners, Landreth Fastener, Northern Wire, LLC), a metal finishing company (Best Metal Finishing), and an offshore sourcing and engineering division (Elgin Fasteners International).

Contact Elgin Fastener Group via phone at 812-689-8917, or visit their website at [www.elginfasteners.com](http://www.elginfasteners.com). Also find Elgin Fastener Group on Facebook and Twitter.

# FASTENER INDUSTRY WEBSITE DIRECTORY

For easy access to all of these websites, log on to [www.linkmagazine.com](http://www.linkmagazine.com) and click on the ad of your choice for a direct hot LINK!



**Tamper-Proof  
Screws, Inc.**  
California

[www.tamperpruf.com](http://www.tamperpruf.com)  
e-mail: [tamperpruf90723@sbcglobal.net](mailto:tamperpruf90723@sbcglobal.net)  
*The Ultimate Source in Security Fasteners*

**TITAN FASTENER  
PRODUCTS**

[titanfasteners.com](http://titanfasteners.com)  
800.789.8112

*Experience the Titan difference  
in packaged fasteners!*

34,000 fastener lines in stock.

**TRINITY  
HARDWARE HEADQUARTERS™**  
PARTS DONE RIGHT.

[www.TrinityHardwareHQ.com](http://www.TrinityHardwareHQ.com)  
[sales@TrinityHardwareHQ.com](mailto:sales@TrinityHardwareHQ.com)  
888-232-1010

**TriState** 

800.410.4558  
Fax: 330.656.4175



Specialists in Studs & Threaded Rods

*See our catalog in the Thomas Register  
and on the Internet at:*

[www.thomasregister.com](http://www.thomasregister.com)

**TUTTLE  
MFG. CO.** 

**UMETA  
OF AMERICA INC.**

OEM Quality Grease Fittings  
and Grease Guns

[www.umetausa.com](http://www.umetausa.com)

**Unbrako**

BUILT FOR LIFE.

[www.unbrako.ca](http://www.unbrako.ca)

**UI** UNIQUE  
INDUSTRIES, INC.

*Manufacturer of  
Specialty Threaded Items*

[www.uiind.com](http://www.uiind.com) • [sales@uiind.com](mailto:sales@uiind.com)

THE CONTRIBUTORS **LINK**

THE NATIONAL MAGAZINE FOR FASTENER DISTRIBUTORS

See the new online magazine at  
[www.linkmagazine.com](http://www.linkmagazine.com)

New Digital Magazine

**USA**



**FASTENER  
GROUP, INC.**

[www.usafgrp.com](http://www.usafgrp.com)

**VAF**

**VIRGINIA FASTENERS**  
*The Galvanized Source*

[www.vafasteners.com](http://www.vafasteners.com)

**VMG**  
ENGINEERING, INC.  
SINCE 1989

[www.vmgengineering.com](http://www.vmgengineering.com)

1046 Griswold Ave, San Fernando, CA 91340 Tel: (818) 837-6320 Fax: (818) 837-6326



**VOGELSANG CORPORATION**  
800-526-2376

Manufacturer of Spring Pins,  
Rollpins® (slotted & coiled)  
and the Engineered-RollPin™

[www.VogelsangCorp.com](http://www.VogelsangCorp.com)

**VOLT  
INDUSTRIAL PLASTICS, INC.**

*Finest nylon fasteners in the world.*

[www.voltplastics.com](http://www.voltplastics.com)  
[www.thomasregister.com/volt](http://www.thomasregister.com/volt)  
e-mail: [service@voltplastics.com](mailto:service@voltplastics.com)

[www.wclco.com](http://www.wclco.com)

**WCL**

*"Your Link to Success"*

**WESTERN WIRE**

**Western Wire Products Co.**

[www.westernwireprod.com](http://www.westernwireprod.com)  
E-mail: [sales@westernwireprod.com](mailto:sales@westernwireprod.com)

STAMPING THE FUTURE  
WROUGHT WASHER MFG., INC.



PHONE 414 744-0771 • 1-800-558-5217 • FAX 414-482-0144  
[WWW.WROUGHTWASHER.COM](http://WWW.WROUGHTWASHER.COM)

**WYANDOTTE  
INDUSTRIES, Inc.**

[www.wyandotte.com](http://www.wyandotte.com)  
(734) 283-1870 • Fax (734) 283-6166

**HAVE YOU  
SEEN US  
ONLINE?**

[www.linkmagazine.com](http://www.linkmagazine.com)

Order 2-Line Today  
855.254.1194

U.S. Industrial Enamels  
Alkyd Enamels  
Acrylic Enamels  
Lacquer Enamels  
Primer Enamels  
Welding Supplies  
Marking Accessories  
Traffic Marking Paint  
Utility Marking Paint  
Athletic Field Marking  
Cleaners & Degreasers



Z-Line Industrial P.O. Box 1090 Menomonee Falls, WI 53052 [www.z-linehighperformancefinishes.com](http://www.z-linehighperformancefinishes.com)

**ZNB**

since 1988

[www.zonbix.com.tw](http://www.zonbix.com.tw)

# Your #1 Source for Precision Electronic Hardware

## Custom Parts Manufacturing



## Precision Shoulder Screws

MS51575, MS51576



## Online NAS Parts Catalog

Lyn-Tron now offers NAS style part numbers as a standard catalog line item. Visit [lyntron.com/nas](http://lyntron.com/nas) for real-time stock levels and pricing.

Call Today: 800-423-2734

LYN-TRON, INC.

Home | Catalog | Pricing | Technical | Manufacturing | Parts | About

Product Catalog

Custom Projects

Technical

Call Today: 800-423-2734

LYN-TRON, INC.

Home | Catalog | Pricing | Technical | Manufacturing | Parts | About

3/8 HEX FEMALE STANDOFF

NAS1831XX-XXXX

Lyn-Tron Part ID: NAS1831C6D16 Catalog Page: H33 Qty Available: 2,282

Material Code	Material Description	Dimension Code	Dimension Description	Thread Code	Thread Value	Length Code	Length Value
AC	Aluminum, Chemical Cleaned	03	3/8 IN	F D	1640.32	16	1 IN
04	Steel, Cadmium Plated	04	1/8 IN	E	1900.32	17	1-1/16 IN
05	Steel, Tin Plated	05	5/16 IN			18	1-1/8 IN
06	Steel, Tin Plated	06	3/8 IN			19	1-3/16 IN
07	Stainless Steel, Passivated	07	1/8 IN			20	1-1/4 IN
08	Nylon	08	1/8 IN			21	1-5/16 IN
09	Nylon	09	1/8 IN			22	1-3/8 IN



[www.lyntron.com](http://www.lyntron.com)

Phone: (800) 423-2734

Fax: (509) 456-0946



# Fastener Reference Guide. A Great Gift for Customers.

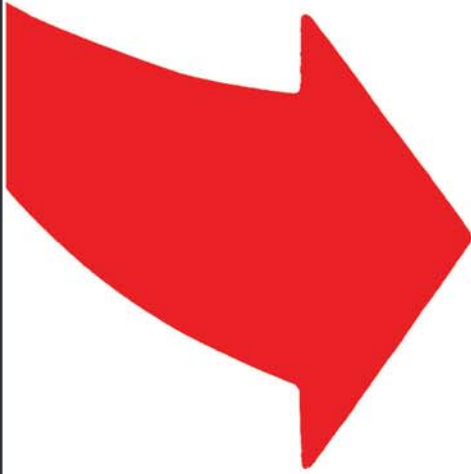

## A Great Way to Advertise Your Company.

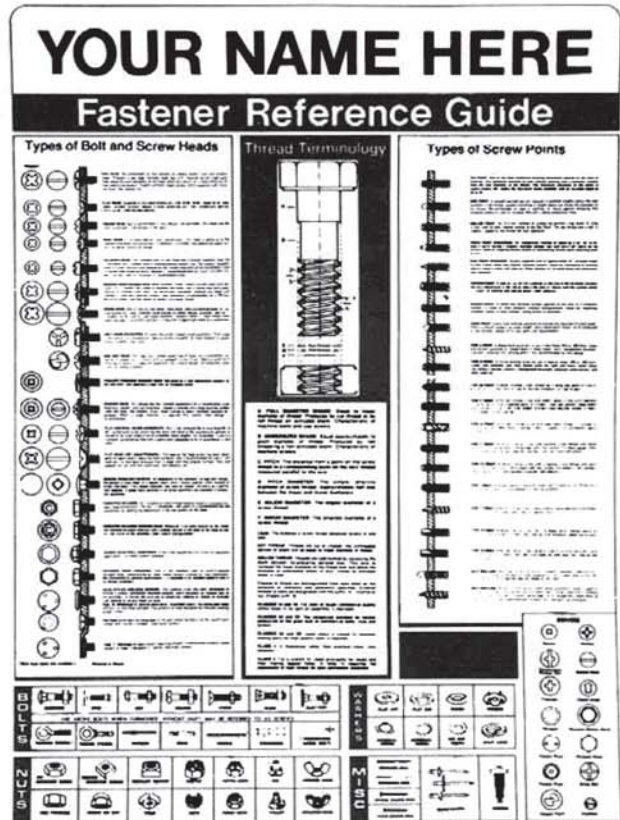

This 17" x 22" handy reference guide for common fasteners will serve as an attractive and informative addition to your customers' offices and stockrooms.

Your name, logo, address, phone number, e-mail, and/or web site address are all boldly and handsomely printed above detailed descriptions of common screws, sheet metal screws, machine screws, bolts, nuts and washers. It's a great way to personalize your company's image and advertise your capabilities at the same time.

The poster is made of sturdy heavyweight paper printed in red and black. It's the perfect giveaway for both existing and potential customers!

To have a company logo printed on the chart, please provide a clean, black & white copy of the logo or line art (can be printed or digital).

To order, fill out the form below and return to:  
**Distributor's Link Magazine**, 4297 Corporate Square, Naples, FL 34104 • Ph. 800-356-1639

Ship to: \_\_\_\_\_  
 Name \_\_\_\_\_ Company \_\_\_\_\_  
 \_\_\_\_\_  
 Address \_\_\_\_\_ City \_\_\_\_\_ State \_\_\_\_\_ Zip \_\_\_\_\_

**250 copies: \$275 • 500 copies: \$395** • Inquire about larger quantities. Prices do not include shipping. We will send them UPS Freight Collect or bill your UPS or Fedex Number # \_\_\_\_\_

*Please include full payment with order. Checks payable to: Leo J. Coar*

# WCL, We're Not Just Lockwashers...

## We Also Specialize In:

- Fasteners
- Flat Washers
- Plastic Components
- Spring Washers
- Threaded Fasteners
- and Lockwashers

With our extensive knowledge and inventory, we're the right partner to help you grow your business.

Call Today!

**800.331.3816**

DDTC REGISTERED

**West Coast Lockwasher Co, Inc.**

16730 East Johnson Dr., P.O. Box 3588, Industry, CA 91744

Email: sales@wclco.com | www.wclco.com



## ARE YOUR TEST DOCUMENTS ACCURATE? HAVE YOUR PRODUCTS BEEN FAIRLY REJECTED? *continued from page 24*

For instance, when changing the anvil on a Rockwell hardness machine from a flat stage to a 'V' anvil for holding rounded specimens, a first indentation is made, then discarded as it produces a load that 'sets' the anvil in place and would otherwise produce a false reading. The same is true for the first readings of the day, after calibrations have been made or after changing any grips or other removable component of the test equipment.

Product could be incorrectly rejected because the F606 clearly states that the average of all readings must meet the minimum hardness reading or higher. This is so that there are no hardnesses readings below minimum, which could indicate heat treatment problems. If not so specified, the product with one low reading could be accepted if the mathematical average was at or above the minimum.

Often, surface hardness is tested as an audit procedure for the heat treatment. However, it is the core hardness that will indicate whether the heat treating process was complete.

The core is the part of the body of a fastener beginning beneath the surface, at a point where the subsurface hardness ends. For example; if a bolt is either carburized

or decarburized, the core begins at the point where the effect of the carburization or decarburization is no longer measurable. The core is not a precise location: therefore, fastener standards universally require the core hardness be measured at mid-radius as the arbitration method.

As with all test procedures, the results are greatly affected by precision and bias. For example, hardness readings are affected by the perpendicularity of the test indenter to the surface. This is critical if grinding a flat spot on a cylindrical surface. Otherwise, remove the coating with an abrasive cloth and use the proper conversion factor for cylindrical surfaces given on hardness charts. When removing surface coatings or burrs, care must be taken to keep both surfaces parallel.

Longer bolts will create a cantilever effect and produce a non-parallel surface. Cut the head off and test either the shank or head.

If the bearing surface of a nut is too small for an indentation, the hex flats may be used. However, the hex flat of a small nut may flex slightly under load. Threading a short bolt into the nut will minimize distortion.

# MWFA GOLF OUTING AND BANQUET EAGLEWOOD RESORT, ITASCA, IL - JUNE 26, 2012



**ARE YOUR TEST DOCUMENTS ACCURATE? HAVE YOUR PRODUCTS BEEN FAIRLY REJECTED?** *continued from page 201*

## **Proof Load**

Since a fastener's performance can only be measured on the complete finished product and yield strength cannot be determined by traditional materials testing procedures, the Proof Load Test was developed as an indicator of ductility and yield performance. By definition, Proof Load is the maximum load a fastener can withstand without incurring permanent set.

The bolt's length is measured to within 0.0001 inches, using spring loaded pointed anvils into drilled depressions, then placed into a tensile testing machine using a hardened thick flat washer under the head as in the Axial Method and tensioned to a predetermined load, which is held for 10 seconds. To have passed, the bolt is measured again and shall exhibit no permanent elongation in excess of a 0.0005-inch tolerance to account for straightening. To save time and sample size, the proof load specimens may be used for the wedge tensile test.

Compensation for 'straightening' must be considered for fastener and threaded rod products that are longer than 8 inches.

The Proof Load test is required for all ASTM A354 Grade BD fasteners. This separates the A354 Grade BD from the SAE J429 Grade 8 fasteners. All Material Test Reports for the ASTM product must have the proof load test results clearly stated as well as the location of the fracture.

## **Axial Tensile Testing**

The primary physical characteristic widely specified by any design engineer or user is the strength of the product, expressed as the 'Ultimate Tensile Strength'. This is the amount of force required to cause total fracture under a simple axial load.

Axial tensile strength is determined when a specimen is pulled to fracture by a machine, where one end of the specimen is attached to a fixed beam and the other to a movable cross-head. The force is measured by a load cell and is recorded as stress, while strain is measured by the movement of the cross-head. Axial tensile tests are also performed on machined test specimens or from full sized products to determine Yield Strength.

## **Wedge Tensile Strength**

Unlike the Axial Test that uses a hardened flat washer under the bolt head, the Wedge Tensile Test uses hardened wedges of different angles used to intentionally stress the bolt's head. The excessive angular loads will verify correct process controls for the heading operation and heat treatment. Therefore, the Wedge Tensile Test is the preferred method to employ for testing full sized products. Labs familiar with testing fasteners will perform the Wedge Tensile Test without asking.

*please turn to page 204*



# Lowest Prices Anywhere!

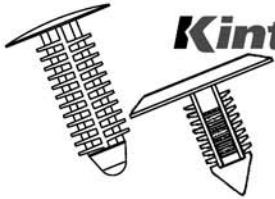

**Kinter**® cross to **ITW Fastex**® & **TRW**® X-Mas Tree Clip finned push-in panel fasteners-Nylon.

AKA: Ratchet Fasteners or Push Pins.

Flexible ribs deflect when pushed into hole then spring back to resist removal.

Samples available upon request.

Special colors, materials, dyes or painted heads also available -please inquire.



ITW Fastex® Item # TRW® Item #	Manufacturer	Kinter Item #	ITW Fastex® Item # TRW® Item #	Manufacturer	Kinter Item #	ITW Fastex® Item # TRW® Item #	Manufacturer	Kinter Item #
647486	TRW®	120205	38-0580-01	ITW Fastex®	120209	354-280317-00	ITW Fastex®	120215
647516	TRW®	120226	38-0635-02	ITW Fastex®	120200	354-280318-00	ITW Fastex®	120266
647536	TRW®	120224	38-0635-06	ITW Fastex®	120201	354-310102-00	ITW Fastex®	120222
647560	TRW®	120220	38-0635-16	ITW Fastex®	120265	M36-0300-01	ITW Fastex®	120245
647561	TRW®	120234	38-0700-03	ITW Fastex®	120217	M36-0500-01	ITW Fastex®	120244
647562	TRW®	120275	38-0714-10	ITW Fastex®	120215	M36-0500-03	ITW Fastex®	120257
647563	TRW®	120272	38-0714-12	ITW Fastex®	120216	M36-0630-07	ITW Fastex®	120262
647564	TRW®	120213	39-0630-10	ITW Fastex®	120205	M36-0630-22	ITW Fastex®	120258
647580	TRW®	120276	39-0650-05	ITW Fastex®	120226	M36-0700-05	ITW Fastex®	120237
647581	TRW®	120214	39-0885-01	ITW Fastex®	120227	M36-0700-07	ITW Fastex®	120235
647599	TRW®	120232	39-1000-01	ITW Fastex®	120223	M36-0700-10	ITW Fastex®	120240
647600	TRW®	120228	236-170406-00	ITW Fastex®	120300	M36-0700-15	ITW Fastex®	120255
647601	TRW®	120233	236-170406-02	ITW Fastex®	120302	M36-0790-04	ITW Fastex®	120246
647602	TRW®	120230	236-170406-03	ITW Fastex®	120303	M36-0790-05	ITW Fastex®	120263
647603	TRW®	120225	236-170406-04	ITW Fastex®	120304	M39-0630-10	ITW Fastex®	120205
647617	TRW®	120247	236-170406-05	ITW Fastex®	120305	M39-0650-05	ITW Fastex®	120226
647618	TRW®	120231	236-170406-07	ITW Fastex®	120307	M39-0885-01	ITW Fastex®	120227
647626	TRW®	120274	236-170406-08	ITW Fastex®	120308	M39-1000-01	ITW Fastex®	120223
647634	TRW®	120269	236-170406-09	ITW Fastex®	120309	PC47486	TRW®	120205
647657	TRW®	120243	236-220603-00	ITW Fastex®	120325	PC47516	TRW®	120226
647669	TRW®	120252	236-220603-02	ITW Fastex®	120327	PC47536	TRW®	120224
647673	TRW®	120249	236-220603-10	ITW Fastex®	120329	PC47560	TRW®	120220
647678	TRW®	120273	236-220604-00	ITW Fastex®	120320	PC47561	TRW®	120234
647695	TRW®	120270	354-070201-00	ITW Fastex®	120242	PC47562	TRW®	120275
647719	TRW®	120271	354-120240-00	ITW Fastex®	120208	PC47563	TRW®	120272
2617-01	ITW Fastex®	120254	354-125300-00	ITW Fastex®	120221	PC47564	TRW®	120213
2619-00	ITW Fastex®	120236	354-156001-00	ITW Fastex®	120207	PC47580	TRW®	120276
2620-00	ITW Fastex®	120268	354-162200-00	ITW Fastex®	120204	PC47581	TRW®	120214
2633-00	ITW Fastex®	120240	354-190001-00	ITW Fastex®	120210	PC47599	TRW®	120232
36-0300-01	ITW Fastex®	120245	354-190001-01	ITW Fastex®	120211	PC47600	TRW®	120228
36-0500-01	ITW Fastex®	120244	354-190300-00	ITW Fastex®	120264	PC47601	TRW®	120233
36-0500-03	ITW Fastex®	120257	354-200101-00	ITW Fastex®	120206	PC47602	TRW®	120230
36-0630-07	ITW Fastex®	120262	354-200102-00	ITW Fastex®	120218	PC47603	TRW®	120225
36-0630-22	ITW Fastex®	120258	354-201960-00	ITW Fastex®	120219	PC47617	TRW®	120247
36-0700-05	ITW Fastex®	120237	354-220000-00	ITW Fastex®	120209	PC47618	TRW®	120231
36-0700-07	ITW Fastex®	120235	354-250103-00	ITW Fastex®	120200	PC47626	TRW®	120274
36-0700-10	ITW Fastex®	120240	354-250303-00	ITW Fastex®	120201	PC47634	TRW®	120269
36-0700-15	ITW Fastex®	120255	354-250304-00	ITW Fastex®	120265	PC47657	TRW®	120243
36-0790-04	ITW Fastex®	120246	354-250311-00	ITW Fastex®	120205	PC47669	TRW®	120252
36-0790-05	ITW Fastex®	120263	354-280301-00	ITW Fastex®	120216	PC47673	TRW®	120249
38-0470-02	ITW Fastex®	120210	354-280305-00	ITW Fastex®	120217	PC47678	TRW®	120273
38-0475-01	ITW Fastex®	120264	354-280307-00	ITW Fastex®	120202	PC47695	TRW®	120270
38-0490-01	ITW Fastex®	120206	354-280308-00	ITW Fastex®	120203	PC47719	TRW®	120271

\*ITW Fastex® (ITW Fastex is a Registered Trademark of The Fastex Division of the Illinois Tool Works Company).

TRW® (TRW is a Registered Trademark of TRW Engineered Fasteners and Components).

Kinter's (K International's) nylon 6/6 X-Mas Tree Clip, Ratchet Rivet and Snap Rivet fasteners are not manufactured by or connected in any way with the producers of ITW Fastex®'s or TRW® fasteners.



3333 Oak Grove Avenue, Waukegan, IL 60087

1-800-323-2389 phone

847-623-0105 fax

kinter.com

**ARE YOUR TEST DOCUMENTS ACCURATE? HAVE YOUR PRODUCTS BEEN FAIRLY REJECTED?** *continued from page 202*

There are length limitations for the products that can be tested. In this case, core hardness tests are sufficient. However, be wary if the size and length is appropriate and the Wedge Tensile Test is not performed.

When the wedge test is completed on standard full sized ferrous cap screw products, and the bolt has fractured, the fracture must always occur in the threads; never at the juncture of the head and shank and never in the shank for heat treated steels. This is regardless of whether or not the minimum tensile load has been achieved or exceeded. The sample must be loaded to complete failure and the fracture must always occur in the threads.

Fractures occurring outside the threads are permitted for non-ferrous materials and low carbon steels, as the threads may cold work faster than the shank. Thus, the area of the shank may be reduced until fracture. However, the standard thread stress area formula still applies for stress calculations as the original tensile stresses originate in the smallest cross-sectional area, the threads.

Testing the full sized fastener product is perhaps the most important criteria in testing. It verifies proper manufacturing practice and gives an indication of how the fastener may perform in service. The Wedge Tensile will also exhibit grain flow by its ability to successfully support fracture loads without thread stripping or head separation. Head separation can be caused by improper heat treatment, insufficient fillet radius, or even material flashing at the fillet from forging.

### **Yield Strength**

Many design engineers predicate their stress loads on the yield strengths of the materials being used. When a material experiences yield, it has entered its plastic zone where it ceases being elastic. In yield, the material loses its spring-like properties, becomes permanently elongated and loses strength and clamp load.

To test for yield strength, a specimen must be machined from the heat-treated product. The machining is to produce a dog-bone like shape whose cross-sectional area is less than the supporting threads, thereby ensuring the fracture will take place in this predicted area.

Both ends of the specimen may be threaded or, if the fastener is of a large enough diameter, the original head and threads may be used while the shank is machined. The machined area has several specific

dimensions and 'gage lengths' to be compatible with industry standard extensometers. Connected to the machined and reduced shank of the specimen, the extensometer sends stress-strain data to an X-Y recorder.

### **Dimensions and Lengths**

Dimensions are expressed in 'nominal' values. Nominal is a convenient term used to express the approximate dimension of a fastener in whole numbers, without listing tolerances or other factors.

For all axial load tests on standard bolts, there must be a minimum of 6 unengaged threads outside the grip area. Due to the shorter thread length of heavy hex structural bolts, there is a minimum requirement of 4 exposed threads. It has been proven that fewer exposed threads will adversely affect the test results.

The standard maximum test length of a fastener is 8". Beyond this, many machines do not have the capability to accommodate longer lengths. Then, the specimens are machined. However, if the machine's capability allows for longer specimens to be tested, care must be observed when interpreting the results as 'straightening' of the longer length may occur. This may produce some cold working to the sample.

### **Straight Answers to Common Questions:**

- A full sized fastener must always be tested when feasible.
- A complete fracture must always occur. No thread stripping allowed.
- Fracture of heat treated steel fasteners must always be in the threads.
- Fracture may never occur at the head to shank junction at any load; including loads above the minimum tensile requirements.
- Even though the fastener has experienced a load equal to or greater than the minimum tensile load, the test loading must continue to full fracture.
- A sample used for proof load testing may be used for tensile testing.
- When averaging all test readings, such as hardness readings, all recorded test values must meet or exceed the minimum requirement. No reading may be less than the specified minimum to factor in an average.
- You always have the right to have a retest performed for verification. 

## DISTRIBUTOR NEWS

The **Alcoa Fastening Systems'** Huck brand introduces the Huck 360®, an advanced nut-and-bolt fastening system designed never to loosen. This system resists vibration, no matter how intense the environment.



Key to the fastener's vibration resistance is its engineered design: the nut threads are softer and thicker than the bolt threads. When the nut is tightened on the bolt, the bolt threads become embedded in the nut threads, eliminating any "gap" between the nut, pressure flank, and crest of the bolt thread. This design prevents any movement of the nut, while allowing the fastener to absorb very high spike loads.

In addition, the Huck 360 can be installed quickly due to the fact that the nut is designed to free-spin onto the bolt. In studies, the Huck 360 installs in one-third the time needed to install conventional locknuts.

The Huck 360 fastening system is available in 3/8" – 1-3/8" and 10mm – 36mm to fit a wide range of application requirements.

For more information contact Alcoa Fastening Systems at 8001 Imperial Drive, Waco, TX 76714, call 1-800-388-4825 or go to the website at: [www.afsindustrial.com/huck360](http://www.afsindustrial.com/huck360).



**VMG**  
ENGINEERING, INC  
SINCE 1989

### Screw Machine - Electronic Hardware

#### Standoff and Spacers

Standard and Custom Sizes  
Female/Female, Male/Female,  
Swage, Anti-Rotation

#### Handles

Standard Round    Offset  
Rectangular        90°, 180°, Free-Fall  
Oval

#### Standoff and Spacer

Amatom  
RAF  
Keystone  
HH Smith  
Lyntron  
Concord  
Promptus  
Unicorp  
ASM

#### Handles

Amatom  
RAF  
Keystone  
HH Smith  
Lyntron  
Concord  
Promptus  
Unicorp  
Handles Unlimited

#### Military Specs

NAS  
NASM  
NA  
MS

#### Custom Prints

### Material List

#### Aluminum

2011T3  
2017T4  
2024T4  
6061T4/T6  
7075T6

#### Aluminum Bronze

C630  
C642

#### Brass

360  
464

#### Beryllium Copper

C110  
C145  
C172

#### Manganese Bronze

C544

#### Steel

C1018  
12L14  
4130/4140

#### Steel Tubing

1010  
1026

#### Stainless Steel

A286  
8740  
13-8PH  
15-5PH  
17-4PH  
300 Series  
400Series

#### Plastics

Delrin  
PEEK  
Glass Epoxy  
Teflon  
Nylon  
Paper Phenolic  
Turcite  
Polyethylene  
Polycarbonate  
Tefzel  
Polysulfone  
Lamitex

#### Tool Steel

A2  
M2

#### Inconel

718  
X750

#### Specialty Metals

Nitralloy  
52100 Alloy Steel  
L605 Alloy  
9310 Alloy Steel  
8620 Alloy Steel  
Invar 36

Call, Fax, or Email for quotations

TOLL FREE 800.959.7406 • FAX 818.837.6326 • [www.vmgengineering.com](http://www.vmgengineering.com) • 1046 Griswold Avenue, San Fernando, CA 91342



## TECHNOLOGY HELPS WITH INVENTORY MANAGEMENT *continued from page 26*

### Takes Many Factors into Account

The system examines all the information about usage, on hand position, open sales orders, open purchase orders, lead time and stocking objective. Based on the information that it finds, it actually produces requests for quotes for items that can be ordered from many vendors. Then it creates purchase orders for things that are always ordered from one vendor, e.g. branded products, or products that have a preferred vendor.

### Works for Kits, Components and Secondary Processes as Well

Then it looks at the products that must be kitted or processed (plated, drilled, through hardened, etc.) and it creates processing purchase orders for them. Finally, it looks at the raw parts that are going to be needed to produce these products or kits, and it creates requests for quotes, purchase orders or processing purchase orders for the raw parts as well.

All of the documents are automatically created, eliminating hours of data entry and putting an end to errors. The user then reviews the documents. Any line item can be changed from the proposed document to another, e.g. from a processing purchase order to a purchase order for a part that is normally sent out for plating, but is going to be ordered plated this time. Once all the decisions are made, the user simply has the system e-mail, fax or print the documents to send them to the Vendors. When the documents go out to the vendors, of course, each vendor has their own part numbers included, thus eliminating errors and expediting the order process for everyone involved.

Classification	Document	Vendor	Date Req	As of Avl	U.	Qty to Order	Available	Current On Hand	Re-Order Point
DI - 25NL0CZ	RFQ	** 4 **	08-09-12	-35	EA	35	-35	0	0
DI - 31C7HC6SZ	RFQ	** 4 **	08-09-12	-85	EA	95	-85	30	0
DI - 37NL0CZ	RFQ	** 4 **	08-09-12	-1,500	EA	2,500	-1,500	250	100
DI - RIDT15682	PO	W-145 RIDGE TOOL	08-09-12	-1	EA	1,001	-1	0	100
DI - SC30 250-20X1 000	RFQ	** 4 **	08-09-12	-500	EA	500	-500	0	0
DI - SC30 250-20X1 000B0	PPO		08-09-12	-500	EA	1,500	-500	0	100

### Product Inquiries

All through the entire process, the user has complete access to product inquiries that show all of the information that is needed to make an intelligent purchasing decision. Summarized usage is shown below. Detailed usage inquiries are a click away.

Classification	Document	Vendor	Date Req	As of Avl	U.	Qty to Order	Available	Current On Hand	Re-Order Point
DI - 25NL0CZ	RFQ	** 4 **	08-09-12	-35	EA	35	-35	0	0
DI - 31C7HC6SZ	RFQ	** 4 **	08-09-12	-85	EA	95	-85	30	0
DI - 37NL0CZ	RFQ	** 4 **	08-09-12	-1,500	EA	2,500	-1,500	250	100
DI - RIDT15682	PO	W-145 RIDGE TOOL	08-09-12	-1	EA	1,001	-1	0	100
DI - SC30 250-20X1 000	RFQ	** 4 **	08-09-12	-500	EA	500	-500	0	0
DI - SC30 250-20X1 000B0	PPO		08-09-12	-500	EA	1,500	-500	0	100

### Cardex Shows All Activity

Every detail record of the product's usage is accessed to refine the final decision. Is the usage based on an anomaly? Is it a product that the largest customer no longer uses? Who is buying this part and who is the lowest cost vendor? The human judgment factor isn't lost when the Automatic Replenishment System is used. It's just the drudgery that is eliminated.

Date	Name	Description	Qty In	Qty Out	Unit Cost	Unit Price	Price Extension
05-18-12	Carver Sand & Gravel	To: C487504 IHW02470074	40	0.65	3.99	1.62	
03-05-12	Carver Sand & Gravel	To: C487504 IHW02470002	50	0.65	3.99	2.00	
03-01-12	Integrated Lener Technology	To: C487503 IHW02470049	10	0.65	2.35	0.24	
02-09-12	STAR STAINLESS SCREW	To: VSTAR P0H14413	100	0.65	0.65	0.65	
02-02-12	Carver Sand & Gravel	To: C487504 IHW02470050	50	0.65	3.99	2.00	
01-20-12	East Penn Manufacturing Co.	To: V11860 P0M04112	200	0.65	0.65	0.65	
01-01-12	F W Webb Company	To: C487505 IHW02470053	100	0.65	3.99	3.99	
01-01-12	Integrated Lener Technology	To: C487503 IHW02470047	50	0.65	2.32	1.11	
06-01-07	Albert Lea Trailer	To: C46 IHW02302	700	0.65	1.30	9.75	
05-28-07	Albert Lea Trailer	To: C46 IHW02301	1,500	0.65	1.30	19.50	

### Editing Basic Inventory Information

Because of the easy access, editing the inventory master file information is a snap. The basic inventory data can easily be changed immediately, rather than becoming yet another project to do at the end of a hectic day.

Classification	Document	Vendor	Date Req	As of Avl	U.	Qty to Order	Available	Current On Hand	Re-Order Point
DI - 25NL0CZ	RFQ	** 4 **	08-09-12	-35	EA	35	-35	0	0
DI - 31C7HC6SZ	RFQ	** 4 **	08-09-12	-85	EA	95	-85	30	0
DI - 37NL0CZ	RFQ	** 4 **	08-09-12	-1,500	EA	2,500	-1,500	250	100
DI - RIDT15682	PO	W-145 RIDGE TOOL	08-09-12	-1	EA	1,001	-1	0	100
DI - SC30 250-20X1 000	RFQ	** 4 **	08-09-12	-500	EA	500	-500	0	0
DI - SC30 250-20X1 000B0	PPO		08-09-12	-500	EA	1,500	-500	0	100

### Automatic Replenishment Changes Everything

The work that is needed to set up the Automatic Replenishment System is worth the effort 100 fold. The system saves countless hours and tedium. Clients that use this system are in complete control of their inventory. They dramatically reduce stock-outs and they also improve their overstock position. They do less work and have better results.

### More Information

Computer Insights, Inc. can be reached at 108 Third Street, Unit 4, Bloomingdale, IL 60108. Their telephone number is 1.800.539.1233, E-mail sales@ci-inc.com and their website is www.ci-inc.com.

# Industrial Nut Corp.

Excellence in Fastener Manufacturing Since 1908 • ISO 9001:2008

## Your customer demands Total Satisfaction

### We offer:

- Application engineering and field sales support
- Value engineering analysis drawing from our extensive application knowledge
- Prototype manufacturing and part development based on key and/or critical characteristics of your customers' product and assembly requirements
- Experienced customer support staff to help manage your customers' needs
- The optimum possible blend of high quality domestic manufacturing and worldwide sources of supply

## You demand The Best Product

### We provide:

- Domestic product manufactured from bar, forgings and castings in sizes ranging from 1/2" to 8" and M12 to M200
- Precision product with the flatness and perpendicularity your customer requires
- Large diameter domestic nylon insert locknuts from stock, released in multiples of our box quantity to help reduce inventory and increase profitability
- Special nuts and locknuts made to print

We offer many types of internally threaded fasteners in addition to those noted above, in METRIC, INCH and thread forms.

Visit our updated website at [www.industrialnut.com](http://www.industrialnut.com) for a more comprehensive understanding of our history, capabilities and product offerings.



## Industrial Nut Corp.

1425 Tiffin Avenue • Sandusky, Ohio 44870  
Phone 419-625-8543 • FAX 419-625-5517  
[sales@industrialnut.com](mailto:sales@industrialnut.com)

**Domestic  
Manufacturer**

See us at "Fastener Show West,"  
Booth #427

# NEW ENGLAND FASTENER DISTRIBUTOR'S ASSOCIATION 2012 SCHOLARSHIP GOLF OUTING - JUNE 5, 2012





**I.S.C / World Horizons**  
 910 SW 12th Ave, Pompano Beach, FL 33069  
 Tel: 1-800-741-4278 Fax: 1-800-892-0983  
 email: [info@isc-sales.com](mailto:info@isc-sales.com)

[www.isc-sales.com](http://www.isc-sales.com)

**ISC is a Niche Wholesaler of Fastener & Building Products**

NO MINIMUM ORDER | SAME DAY SHIPPING | PRIVATE LABELING AT NO EXTRA COST



NYLON CABLE TIES | ELECTRICAL WIRE NUTS | STRUT & STRUT ACCESSORIES

CONICAL ANCHORS & KITS | EZ ANCHORS & KITS

WIFI - Pam Berry • Tel: 617-962-3355 • Email: [pberry@advancecomponents.com](mailto:pberry@advancecomponents.com) • Web: [www.fastenerwomen.com](http://www.fastenerwomen.com)

## WOMEN IN THE FASTENER INDUSTRY

# WIFI OFFERS SCHOLARSHIP & MENTORING

Women In the Fastener Industry (WIFI) is pleased to announce the launch of its scholarship and mentoring programs. Both programs were created to help further the careers of women who work in the fastener industry and related fields.

Two scholarships, both dedicated to the memory of outstanding women in the fastener industry, are available for eligible members. The Ann Bisgyer Wolz Scholarship honors the memory of the co-publisher of Fastener Industry News, who spent much of her adult life working in and reporting on the fastener business. The Edith Cameron Scholarship is named after a woman who was a pioneer in the field for 55 years. The WIFI Scholarship Committee is comprised of women who are dedicated to furthering educational opportunities for WIFI members. They are: Sandy Wilson, Spaenaur Co.; Joanne Bialis, International Fasteners and Nancy Rich, Midwest Fastener Association.

The WIFI Mentoring Program helps connect members

to industry veterans who are happy to share their work-related experiences along with advice on juggling family and work. The WIFI Mentoring Committee will help make the perfect connection so that members get the most out of the experience. Mentoring Committee members are: Sara Vasicek, Aztech Locknut; Ruth Dowling, Ningbo Jinding; and Mary Lou Aderman, The Aderman Co.

Applications for the scholarship and mentoring program are available on WIFI's website [www.fastenerwomen.com](http://www.fastenerwomen.com).

The WIFI Speaker Series at the National Industrial Fastener and Mill Supply Show in Las Vegas on October 10th, 2 – 4PM, will feature Sandi Cardillo, president of Conrad

Associates, speaking about "Women in Leadership: An Evolving Perspective." An awesome networking event will follow the speech. All are welcome to attend. Tickets are \$15 for WIFI members, and \$25 for non-members.

WIFI will be at the NIFMSE Vegas show, Oct. 11-12, 2012, Booth 1504. 



## NATIONAL INDUSTRIAL FASTENER &amp; MILL SUPPLY EXPO

VEGAS FASTENER EXPO ROARS PAST 700 EXHIBIT SPACES: LARGE TURNOUT EXPECTED *continued from 178*

34 North High Street • New Albany, OH 43054 • Phone 614-895-1279 • Fax 614-895-3466 • www.fastenershow.com

## National Industrial Fastener &amp; Mill Supply Expo Exhibitor List as of 8/15/2012

(AIC) BAI Publishers, Inc.  
 3 Star Rivets Manufacture  
 3M Electrical Markets Division  
 A. Lyons & Company, Inc.  
 A.H. Export  
 Abbott Rubber Co., Inc.  
 Abhi Metals  
 Able Label Systems, LLC  
 Accurate Manufactured Products Group, Inc.  
 ACS Manufacturing  
 ACT Fastening Solutions  
 Advance Components  
 Advanced Poly-Packaging, Inc.  
 Advantage Sales & Supply Co., Inc.  
 AEH Fasten Industries Co., Ltd.  
 Aerodyne Alloys, LLC  
 Aerospace Manufacturing & Design Magazine  
 AFI Industries  
 Aimreach International Co Ltd  
 Ajax Wire Specialty Co., Inc.  
 Alcoa Fastening Systems  
 Alcoa Fastening Systems - Mairoil  
 Alfa Tools  
 All America Threaded Products, Inc.  
 All Electronics Hardware, Inc.  
 All Special, Inc.  
 All Valley Hose & Industrial Supply, LLC  
 Allegheny Bolt & Screw Corp.  
 Amalga Corporation  
 American Fastener Journal  
 American Fasteners and Components  
 American Galvanizers Association  
 American Jebco Corporation  
 American Ring Mfg.  
 Anchor Bolt & Screw Company  
 Anderson Controls, Inc.  
 Anderson Metals Corp., Inc.  
 Andre Corporation  
 Androck Hardware Corporation  
 A-Plus Screws, Inc.  
 Associated Spring Raymond  
 A-Stainless International Co., Ltd.  
 Atlanta Rod & Mfg. Co., Inc.  
 Atlas(r) a PEM Company  
 Auto Bolt Company  
 Autocraft Industrial (Shanghai) Ltd.  
 Automation Systems  
 AVK Industrial Products  
 AZ Lifting Hardware  
 Aztech Locknut Company  
 B&D Cold Heading  
 B&G Manufacturing Company  
 Babu Exports  
 Barbarotto Int'l Machinery  
 Batching Systems Inc.  
 Bay Standard Mfg., Inc.  
 Beacon Fasteners & Components, Inc.  
 Belleville International  
 Beneri SPA  
 Beta Steel  
 BGM Fastener Co., Inc.  
 Big Bolt Corporation  
 Bi-Mirth Corp  
 Binder Metal Products, Inc.  
 Boker's, Inc.  
 Booming Fastener Co., Ltd.  
 Bossard Metrics  
 Bradley Adhesive Applications  
 Brico Industries Inc.  
 Brighton-Best International, Inc.  
 Brikksen  
 Brynolf Manufacturing, Inc.  
 Buckeye Fasteners  
 Bufab USA, Inc.  
 Cable Tie Express, Inc.  
 Capital Steel & Wire, Inc.  
 Cardinal Fastener Inc.  
 Carlo Salvi S.p.A.  
 Carpenter Technology Corporation  
 CEIA USA  
 Champion Cutting Tool Corp  
 Changhong Plastic Co., Ltd.  
 Chem-Plate Industries, Inc.  
 Chicago Hardware & Fixture Co.  
 China Fastener Info  
 ChinaFastener Magazine  
 Ching lee Industrial Co., Ltd.  
 Chite Enterprises Co., Ltd.  
 Chrislynn Threaded Inserts  
 Chu Wu Industrial Co., Ltd.  
 Cinco Industries/Accuvison  
 Clamps, Inc.  
 Cleveland City Forge  
 CMT/Modform  
 Cold Heading Co  
 Collars and Couplings, Inc.  
 Computer Insights, Inc.  
 Consolidated Toledo Drill  
 Continental-Aero  
 Contorq Components  
 Copper State Bolt and Nut  
 Coronet Parts Mfg Co. Inc.  
 Coupling Nut Supply  
 Craftline Storage Systems  
 Creative Carbide Inc  
 Crescent Manufacturing  
 Crossroad Distributor Source  
 CSM Fastener Products Co.  
 Curtis Metal Finishing Company  
 CYW, Inc.  
 Dan-Loc Bolt & Gasket  
 Darling Bolt Company  
 DDI System  
 Decker Manufacturing Corp.  
 Delta Engineering, LLC  
 Detroit Washers & Specials  
 Ding Sen/Heartland Fasteners  
 Disc and Belleville, Inc.  
 Distribution One, Inc.  
 Distributor's Link Inc.  
 Divspec  
 Dongtai QB Stainless Co., Ltd.  
 Dra-Goon Fastener Inc.  
 Drillco Cutting Tools, Inc.  
 Dunkley International Inc.  
 Durham Manufacturing  
 Dynacast Industrial Products  
 Dyson Corporation  
 E Z Sockets Inc.  
 Eagle Metalware Co., Ltd.  
 Eastport Fastener Manufacturing Co., Ltd.  
 EBC Industries  
 EC Fastener  
 Editoriale UPIVEB  
 Edward W Daniel LLC  
 EFC International  
 Element  
 Elgin Fastener Group  
 Elite Sales, Inc.  
 Epicor Software Corp.  
 Ernst Reinhardt GmbH  
 E-Z Lok  
 Fall River Mfg. Co., Inc.  
 Fascomp Electronic Hardware  
 Fasnep Corp.  
 Fastar, Inc.  
 FastCor  
 Fastener Jamher Taiwan Inc.  
 Fastener Training Institute (TM)  
 FastenersClearingHouse.com  
 Fastenique Structural Rivets Co., Ltd.  
 Fath Inc  
 Fehr Bros Industries, Inc.  
 Feng Yi Steel Co Ltd  
 FH Machinery Inc.  
 Filrox Industrial Co., Ltd.  
 Ford Fasteners, Inc.  
 Forest City Technologies, Inc.  
 Formed Fastener  
 Freundlich Supply Co., Inc - Tiger-Tight Corp.  
 Fwu Kuang Enterprises Co., Ltd.  
 G L Huyett  
 G.W.Y., Inc  
 Gaffney Bolt Company  
 Gage Blitt, Inc.  
 General Inspection, LLC  
 GF&D Systems, Inc.  
 Giant Link Enterprise Co., Ltd.  
 GoodGood Manufacturers  
 Graham Fasteners, Inc.  
 Grand Industries Co., Ltd.  
 Grand Industries Co., Ltd.  
 Greenslade & Company, Inc.  
 GRK Fasteners  
 Groov-Pin / PTC  
 Growermetal  
 H W Eckhardt Corporation  
 Haiyan County Fuxin High Strength Fastener Factor  
 Haiyan Daimeiyi Standard Fasteners Co., Ltd.  
 Haiyan Dingfeng Fasteners Ltd.  
 Haiyan Fujian Fastener Co., Ltd.  
 Haiyan Guangda Hardware Co., Ltd  
 Haiyan Guanming Hardware Co., Ltd.  
 Haiyan Heaven & Earth Hardware and Machinery Co.,  
 Haiyan Huilian General Fitting Co., Ltd.  
 Haiyan Hurras Import & Export Co., Ltd.  
 Haiyan Mengshi Bolt Co Ltd  
 Haiyan Samson Machinery Co., Ltd.  
 Haiyan Sanma Standard Hardware Co., Ltd.  
 Haiyan Tianren Machinery Manufacturing Co., Ltd.  
 Haiyan Xinyue Electrical Hardware and Machinery Co  
 Haiyan Yuanyang Standard Piece Co., Ltd.  
 Hanger Bolt & Stud Co.  
 Hangzhou Ailong Metal Products Co., Ltd.  
 Hangzhou Ankou Hardware Co., Ltd.  
 Hangzhou Esrom Hardware  
 Hanmaster Corporation  
 Hariton Machinery Co., Inc.  
 Hawk Fastener Services, LLC  
 Header Plan Co., Inc.  
 Heads and All Threads Ltd  
 Heico-Lock USA  
 Hengruna Fastener Co., Ltd.  
 Hercules Wheel Bolts and Studs  
 Heroslam SAL  
 Hillsdale Terminal  
 Hindley Mfg. Co., Inc.  
 Hit Tools USA  
 Holo-Krome  
 Home Soon Enterprise Co., Ltd.  
 Hongfu Hardware Tangshan  
 Hsin Ho Mfg Co Ltd  
 Hsiung Jen Industrial Co., Ltd.  
 Hu Pao Industries Co., Ltd.  
 Hunan Liangang Fasteners Co., Ltd.  
 Hwaguo Industrial Fasteners Co Ltd  
 I.S.C./World Horizons  
 Ideal Fasteners Inc  
 Ideal-Tridon  
 ifastgroupe / Infasco  
 ifastgroupe/GFS  
 Index Fasteners Inc.  
 Industrial Fasteners Institute (IFI)  
 Industrial Nut Corp.  
 Industrial Rivet & Fastener Company  
 Indux S A de C V  
 Innovative Components, Inc.  
 Integrated Computing Solutions  
 Intercorp  
 Interfast Group  
 Interfast Inc.  
 International Fasteners, Inc.  
 Interstate Threaded Products  
 Intools, Inc.  
 Inventory Sales Company  
 InxSQL Software  
 J.C. Grand Corporation  
 Jau Yeou Industry Co., Ltd.  
 Jay-Cee Sales & Rivet  
 Jet-Lube, Inc.  
 JFD Industries, Inc.  
 Jiangsu AWD Fastener Co., Ltd.  
 Jiashan Huihui Metal Products Co., Ltd.  
 Jiashan Steelfit Trading Co., Ltd.  
 Jiashan Yongda Screw Co Ltd  
 Jiashan Zhongchun Imp. & Exp. Trade Co., Ltd.  
 Jiaxing Dazhe Fastener Co., Ltd.  
 Jiaxing Xinyue Standard Parts Co., Ltd.  
 Jinan High Strength Standard Parts Co .Ltd.  
 Jinan Star Fastener Co., Ltd.  
 Jing Fong Industry Co Ltd  
 Jinjiang Hengfeng Rivet Manufacture Co. Ltd.  
 JM Tor Par, S.A. de C.V.  
 JN Machinery Corp.  
 Kapurthala Industrial Corporation  
 KCS Enterprise Co., Ltd.  
 Kelko Products Co.  
 Ken Forging Inc  
 Kerr Lakeside, Inc.  
 Key Belleilles, Inc.  
 Kind-Auspice Industrial Co Ltd  
 Kinefac Corporation  
 King Steel Corp.  
 Kirk Trading Co., Inc.  
 KPF  
 Ku Fu Fasteners Co., Ltd.  
 Kunlun Development (Asia) Co., Ltd.  
 L & W Fasteners Co., Ltd.  
 Lamons  
 Leland Industries, Inc.

Continued on page 216



# SpringFast

**WHEN QUALITY & SERVICE  
ARE AS IMPORTANT AS PRICE...**

*Bigger is NOT always Better!*



- \* Lock Nuts - Regular & Washer type
- \* Push-on Bolt Retainers
- \* Lock Nuts - Acorn & Wing type
- \* Single-Thread U-Nuts
- \* Multi-Thread U-Nuts
- \* Staked Hex U-Nuts
- \* Tension Nuts
- \* Self Threading Nuts - washer type
- \* Self Threading Nuts - Regular Hex types
- \* Push-on Fastener - Flat Round
- \* Push-on - Arched, Round & Rectangular
- \* Rimmed Push-on Nuts
- \* Dart & U-Clips
- \* Quarter Turn Fasteners

[www.springfastri.com](http://www.springfastri.com)

**FACEBOOK'S OVERHAUL: HOW FASTENERS ARE NAVIGATING THE NEW LOOK WITH PANACHE** *continued from page 30*

Running down the extreme right margin of your start page, Facebook is also mandating that you create a 'Timeline.' This new feature is essentially a vertical list of hotlinked dates, which lead to posts and images chronicling your company's history.

### *Use Care Selecting a Banner Image*

Facebook sees the banner image as an opportunity for you to give visitors a feel for your brand. So it's prohibiting businesses from using the giant image simply to sell stuff. In practice, that means you won't be able to post an image with a '50% off' come-on, or populate the image with phrases like 'limited time offer' or '2-for-1.' Ditto for including other info, such as your email address, Web address or mailing address. Facebook prohibits embedding that kind of info in the banner image.

For optimum display, Facebook recommends your banner image measure 851 pixels by 315 pixels.

### *Create a Mandatory Timeline*

If your fastener distributorship has a rich, interesting heritage, you're in luck. With the aforementioned Timeline running down the extreme right margin of your page, you'll be able to tell your company's story in words and images. In practice, this will mean selecting a series of 'Milestones' in your company's history, which will appear as hotlinked dates stacked vertically on the right side of your start page.

If your marketing staff excels at this kind of creative storytelling, Timeline may offer your company an excellent opportunity to connect with visitors. "In the end, even those who are skeptical about the concept will find that the new Timeline offers greater connectivity and branding opportunities," says WireWalkersVA's Lee.

### *Pin Important News/Posts Up Top:*

A new feature, post-pinning enables your company to anchor a post near the very top of your start page for up

to seven days. This is perfect for businesses looking to add staying power to important company news. Plus, it can keep a special offer or sale top-of-mind for visitors for an extended period of time. Such posts, like all other posts, can also include images.

### *Hide/Delete Unwanted Posts*

Warning – with the redesign, old unwanted posts may automatically be incorporated into your Timeline by Facebook. Fortunately, Facebook offers a tool that will enable you to hide or delete old posts that reflect badly on your company, or simply need to be removed.

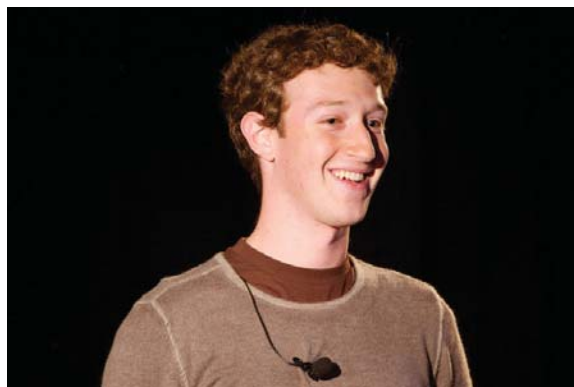

*Above: Facebook's CEO Mark Zuckerberg says more than 900 million people use the social network on a monthly basis.*

*Below: A Facebook server room in Prineville, Oregon*

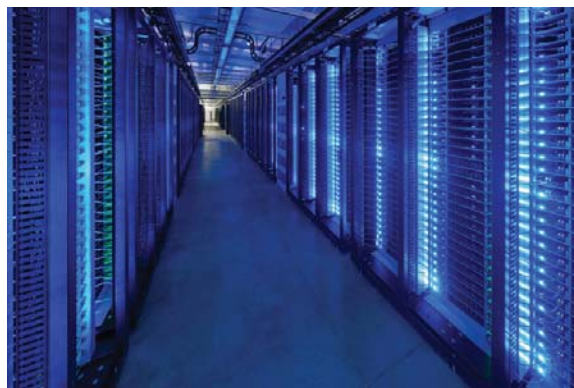

### *Be Aware of 'Visitor Graffiti'*

One of the dicier elements of Facebook's new start page is that it is so chillingly efficient at tracking what Facebook 'friends' are saying about your company. For good or bad, all those posts will show in an activity box just below your banner photo. The box is put there by Facebook, and your company has no way to remove it.

Essentially, your company may spend tens of thousands or even millions of marketing dollars to ensure your start page on Facebook looks and feels just right.

But all those considerable efforts can be undone in a nanosecond if my friend Wilbur has a bad experience with your

fastener firm, and posts an especially nasty review about what happened while he is on Facebook. Unfortunately, the way the new start page is designed, Wilbur's nasty review may pop up – front and center in an activity box – for any of Wilbur's Facebook's friends who happen to visit your Facebook page.

### *Ain't Technology Great?*

Of course, the reverse is true. If my friend Madeline absolutely adores your product or service, and posts that review while on Facebook, her glowing accolade will also probably also pop up on your company start page any time any of Madeline's Facebook friends stop by.

# Introducing The Precision Engineered SCREW IDENTIFIER

LIKE ALL GREAT IDEAS, IT'S INCREDIBLY SIMPLE  
**IT'S THREADED!**

## SAVES TIME & PREVENTS COSTLY ERRORS

How much valuable time has been lost by mechanics, maintenance people and do-it-yourselfers in guessing of screw sizes? How many dollars in damage is done each year through the use of the wrong size screws?

The Screw Identifier is an easy to use, fool-proof tool that eliminates all the guesswork out of screw selection!

## HOW IT WORKS

The precision engineered 'Screw Identifier' saves time and prevents costly errors by first, identifying a threaded fastener by diameter. When accepted in one of the threaded holes from the row that called out the diameter, shows you the pitch. The 'Screw Identifier' is able to identify both Unified National Coarse and Unified National Fine thread pitches.

## FEATURES

Manufactured out of 12 gauge steel and measuring just 2 7/16" x 6 5/8" [shown actual size], the 'Screw Identifier' is both compact and portable. It is clearly and vividly marked with long-life furnace baked epoxy ink and attractively packaged in a see-thru polyethylene case.

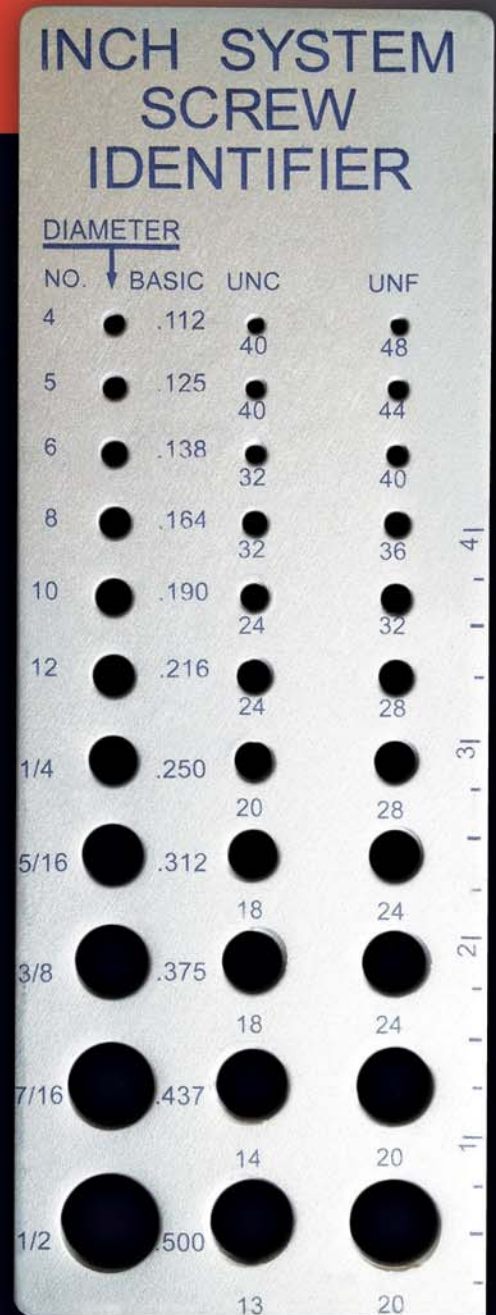

**\$15** LIST PRICE  
QUANTITY DISCOUNTS AVAILABLE

**FACEBOOK'S OVERHAUL: HOW FASTENERS ARE NAVIGATING THE NEW LOOK WITH PANACHE** *continued from page 212*

As you might imagine, the graffiti factor has left many businesses a little gun-shy.

**Consider Private Messaging**

As a kind of counter-balance to the graffiti factor, Facebook has also introduced company/visitor private messaging with this latest upgrade. The feature enables your company to handle tricky customer service problems via private messaging. It's a welcome relief to scores of businesses who previously were often forced to publicly wrestle customer complaints and public relations nightmares on Facebook walls, according to Punch's Goid.

Of course, if you'd rather not handle customer complaints in this way, Facebook enables you to eliminate private messaging altogether.

**Say Good-Bye to Custom Landing Pages**

In another controversial move, the latest Facebook redesign no longer allows businesses to create custom landing pages. Every visitor who clicks to your Facebook presence is automatically routed to your start page. No exceptions.

More than a few firms are grouching about this particular mandate, given that many had spent considerable time and money coming up with stunning custom landing pages that worked just fine, thank you, under Facebook's previous design format.

**Check Out the New Admin Panel**

Virtually every aspect of your Facebook presence can be managed and monitored from the new Admin Panel. Here, you can work with page and privacy settings and engage in private messaging with visitors. You can also monitor visitor activity with Admin Panel, including who's 'Liking' your fastener business. "From a research and review viewpoint the new admin panel is much more user-friendly," says Punch's Goid.

**Get More Help**

There's plenty of help available for companies that are looking to migrate to the new look at Facebook's help center which can be found by navigating to (<http://www.facebook.com/help/?page=240939812618946>)

# NEFDA BOARD ELECTIONS STURBRIDGE, MA - JULY 12, 2012





*'The Distributor's Distributor!'*

**Solid, Semi-Tubular, Blind & Drive Rivets  
Rivet Nuts, Threaded Inserts & Wire Inserts**

*Quality You Can Rely On...ISO 9001 and AS9100  
Quality Assurance in accordance with Aerospace Requirements for Distribution and Servicing*

*Large Selection of Aerospace & Commercial Rivets  
**ALWAYS IN STOCK & READY TO SHIP***



121 Toledo St, Farmingdale, NY 11735 | Tel: 631-249-0400 | Fax: 631-249-0401 | Email: sales@rapidrivet.com

**1-800-RAPIDRT (727-4378)  
www.rapidrivet.com**



**CABLE TIE EXPRESS...AT YOUR SERVICE!** *continued from page 92*

### **SERVICE....to our customers....**

Char stands a little taller as she recently highlighted the tag line for Cable Tie Express, "Our tag line - 'tying service to quality' - sums up in four small words just what we embrace each and every day with our customers. In previous LINK articles (Cable Ties 101, LINK Spring 2011; Heat Shrink Tubing 101, LINK Fall 2011), we discussed the quality products we sell but clearly the focus of this article emphasizes our goal of providing the highest level of service to our customers. Coupled with our tag line, our mission statement, developed in 1995 - "to be the most responsive, dependable, and knowledgeable provider of superior quality cable ties and associated products" - remains the same today and truly speaks of who we are at Cable Tie Express."

With every phone call, email, and communication, SERVICING customers is the energizing force behind each transaction. Same day shipping of orders, immediate

turnaround on quote requests, and cross referencing of parts work hand in hand to enable customers to achieve their goals of securing new business, maximizing gross margins, increasing inventory turns, and meeting goals leading to a stronger bottom line.



The listing of services from Cable Tie Express continues with custom labeling and packaging capabilities, opportunities for making joint sales calls with Cable Tie Express sales agents, training programs to enhance product and application knowledge, and marketing assistance for growing sales.

Looking forward to hopping on the Cable Tie Express bandwagon and realizing the benefits of the SERVICES - as well as the QUALITY products - offered to Cable Tie Express customers?

Contact Cable Tie Express via phone: 1-888-603-1233; fax: 1-800-395-1233 or

email: Sales@CableTIEExpress.com. You'll be treated to that A+ SERVICE at the heart of Cable Tie Express - GUARANTEED! 

## NATIONAL INDUSTRIAL FASTENER & MILL SUPPLY EXPO

VEGAS FASTENER EXPO ROARS PAST 700 EXHIBIT SPACES: LARGE TURNOUT EXPECTED *continued from 210*

34 North High Street • New Albany, OH 43054 • Phone 614-895-1279 • Fax 614-895-3466 • www.fastenershow.com

### National Industrial Fastener & Mill Supply Expo Exhibitor List as of 8/15/2012

LEP Special Fasteners  
 Leyong Industrial (Shanghai) Co., Ltd.  
 Lianyungang Xingyi Fasteners Co., Ltd.  
 Liberty Brass Turning Company  
 Likuo Industrial Co Ltd  
 Lindstrom Fastener Group  
 Linkwell Industry Co., LTD.  
 Linus Products, Inc.  
 Locknut Technology, Inc.  
 Locksure Inc.  
 Lok-Mor Inc.  
 Lone Star/Walker Bolt  
 Long-Lok Corporation  
 Loomis International, Ltd.  
 Lu Chu Shin Yee Works Co., Ltd.  
 Lyn-Tron, Inc.  
 Magni Group, Inc. (The)  
 Magnum Mfg., LLC  
 Magnus Industries, Inc.  
 Mangalam Alloys Limited  
 Master Magnetics, Inc.  
 Master Products Co. (The)  
 Master United Corp.  
 Masterpiece Hardware Industrial Co.  
 Matenaer Corporation  
 MATHread, Inc.  
 MDI - Manufacturing & Design, Inc.  
 MDM Special Tools s.r.l.  
 Mectron Inspection Sytems  
 Mercer Abrasives  
 Metal Coatings Corp  
 Metal Fabricating Corp.  
 Metal Resource Solutions, Inc.  
 Metalurgica Hassmann S/A  
 Metric & Multistandard Components Corp  
 Metric Fasteners Corporation  
 Miao Run Sen China  
 Micro Plastics, Inc.  
 Midalloy Specialty Materials  
 Midland Metal Manufacturing  
 Midwest Control Products  
 Min Kuan Co., Ltd.  
 Minneapolis Washer & Stamping, Inc.  
 Mols Corporation  
 Morton Machine Works  
 Mr. Metric  
 MSI Products  
 Mubea, Inc.  
 Muking Heavy Truck Accessories Co., Ltd.  
 Multi-Tek Fasteners & Parts Manufacturer Corp.  
 MW Industries, Inc.  
 Nakashimada USA  
 Nanmat Technology Co., Ltd.  
 Nantong Da Sheng Fastener Co., Ltd.  
 National Carton & Coating  
 National Fastener Distributors Association (NFDA)  
 National Fastener Industry Finance Group  
 National Machinery Exchange  
 National Machinery LLC  
 National Standard Parts Assoc Inc  
 National Threaded Fasteners Ltd  
 NCG Tools Industry Co., Ltd.  
 ND Industries  
 Nedschroef Herentals NV  
 Ningbo Dongxin High-Strength Nut Co., Ltd.  
 Ningbo Exact Fasteners Co Ltd  
 Ningbo Fastener Factory  
 Ningbo Haixin Hardware Co., Ltd.  
 Ningbo Jinding Fastening Piece Co., Ltd.  
 Ningbo Qunli Fastener Manufacture Co., Ltd.  
 Ningbo Tengliang Industry & Trading Co., Ltd.  
 Ningbo Xinxing Fasteners Manufacture Co., Ltd.  
 Ningbo Xinyang Weiye Import & Export Co., Ltd.  
 Ningbo Yonghong Fasteners Co., Ltd.  
 Ningbo Zhongbin Fastener Mfg. Co., Ltd.  
 Ningbo Zhongjiang Petroleum Pipes & Machinery Co.  
 Nitrex, Inc.  
 Nitto Kohki U.S.A., Inc  
 NOF Metal Coatings International Inc  
 Nord-Lock, Inc.  
 Norseman Drill & Tool  
 North East Fasteners Corporation  
 Northwest Hydra-Line  
 Nucor Fastener  
 Nylok LLC  
 Ofco Industrial Corp  
 Offshore Milling Services, Inc.  
 Ohio Nut & Bolt Company  
 Oread Fasteners (Vietnam) Co., Ltd.  
 Ornit, Inc.  
 OSG-Sterling Die, Inc.

Outback Flashlights, LLC  
 Pacific-West Fastener Association  
 PACMET (A Division of Pacific Metals Group, LLC)  
 Paulin Industries  
 Peak Machinery Sales, Inc.  
 Pentrate Metal Processing  
 Perfect Lock Bolt America, Inc.  
 Perfection Chain Products  
 PINGHU ZHAPU NUT FACTORY  
 Pivot Point Inc  
 Plan-E-Tech Industries, Inc.  
 Plano Moulding Company  
 Portage Packaging Systems, Inc.  
 Porteous Fastener Company  
 Powell Systems, Inc.  
 Praxair Surface Technologies, Inc.  
 Precision Technology Supplies, Ltd.  
 Precision Tool Group  
 Premier Box  
 Pres-on Tape & Gasket  
 Prestige Stamping, Inc.  
 Prestole Fasteners  
 Prospect Fastener Corp.  
 QA1  
 Q-Nuts Industrial Corp.  
 Quantum Storage Systems  
 QuestVapco Corp.  
 Quick Cable Corporation  
 R&D Fasteners  
 R&R Engineering Co., Inc.  
 Raabe Company LLC  
 Radyne Corporation  
 RAF Electronic Hardware  
 Ramco Specialties, Inc.  
 Ray Fu Enterprise Co., Ltd.  
 Ray Industries  
 Reed Machinery, Inc.  
 Reg-Ellen Machine Tool Corp.  
 Regg Inspection  
 Rexlen Corp.  
 Richard Manno & Company  
 Richco, Inc.  
 Ring Masters, LLC.  
 Rivet & Eyelet Technologies, LLC  
 Rivet & Eyelet Technologies, LLC  
 Rockford Fastener Inc  
 Rockform Carbide Manufacturing  
 Rocknel Fastener, Inc.  
 Rolled Alloys  
 Rolled Threads Unlimited  
 Rotor Clip Company  
 RTI International Metals  
 RTM Products, Inc.  
 Ruian Jiulong Fasteners Factory  
 Rumco Fastener Div MW Ind  
 S & M Retaining Rings  
 Safeland Industrial Supply Inc  
 Safety Socket LLC  
 SAIDA Mfg. Co., Ltd  
 Sakai Threading Tool Co., Ltd.  
 Sakamura USA, Inc.  
 Sanhuan Fasteners Co., Ltd.  
 Sarjo Industries, Inc.  
 Saspi Talleres S.A.  
 Screws Industries, Inc.  
 Seastrom Mfg. Co., Inc.  
 Sems & Specials Inc.  
 Sen Chang Industrial Co., Ltd.  
 Set Screw & Mfg. Co.  
 Seymour of Sycamore  
 Shandong Minmetals Co., Ltd.  
 Shandong Tengda Stainless Steel Products Co., Ltd.  
 Shanghai Fast-Fix Rivet Corp.  
 Shanghai Jingyang Fastener Co., Ltd.  
 Shanghai Ming Stainless Co., Ltd.  
 Shanghai Minmetals-Fasteners  
 Shanghai Pinnacle International Trading Co., Ltd.  
 Shanghai Prime Machinery Co., Ltd.  
 Shanghai Qiuming Standard Parts Co., Ltd.  
 Shanghai RECKY International Trading Co., Ltd.  
 SHANGHAI RIVET FASTENER MANUFACTURE CO.,LTD  
 Shanghai Sunray Co., Ltd.  
 Shanghai Sunrise Fasteners Co., Ltd.  
 Shanghai Tianbao Fastener Manufacturing Co., Ltd.  
 Sherex Fastening Solutions, LLC  
 Shin Guang Yin Enterprise Co., Ltd.  
 Shuenn Chang Fa Enterprise Co., Ltd.  
 Sivaco Wire Group  
 Smally Steel Ring Co.  
 Socket Source (The)  
 Solon Manufacturing Co.

Solution Industries  
 Soule, Blake & Wechsler, Inc.  
 Southeastern Fastener Association  
 Southwestern Fastener Association  
 Special Rivets Corp.  
 Specialty Screw Corporation  
 Spectro Wire & Cable, Inc.  
 Spirol Distribution  
 Standing Industrial Co., Ltd.  
 Star Stainless Screw Co.  
 Stelfast Inc.  
 Strut Support Systems  
 Sumeeko Industries Co Ltd  
 Super DPD Co., Ltd.  
 Superior Washer  
 Suzhou Industrial Park Xinkai Precision Fastener  
 Suzhou Jili Stainless Steel Fasteners Factory  
 T.W. International Inc.  
 Taikyu Co., Ltd.  
 Taipei Asia-Pacific Trade International Service  
 Taiwan Fastener Trading Association (TFTA)  
 Taiwan Industrial Fasteners Institute  
 Taiwan Shan Yin International Co., Ltd.  
 Tamper-Pruf Screws, Inc.  
 Tandl Industry Co.,Ltd.  
 Tapco, Inc.  
 Tapoo Metal Products (Shanghai) Co., Ltd.  
 Technical Stamping, Inc.  
 TE-CO  
 Teknoform Baglanti Elemanlari San. ve Tic.A.S.  
 Telefast Industries  
 Tennessee Galvanizing (R)  
 Tesker Manufacturing Corporation  
 Thermo Scientific Niton Handheld XRF Analyzers  
 Thread Choice Fasteners & Tools Co., Ltd.  
 Tianjin Jimkoo International Trade Co., Ltd.  
 Tiodize Co., Inc.  
 Titan Fastener Products, Inc.  
 Titgemeyer (UK) Ltd.  
 Top Worldwide  
 Tortoise Fasteners  
 Tramec LLC  
 Tri Star Metals  
 Triem Industries  
 Trinity Hardware Headquarters  
 Tru-Cut Inc  
 TRU-Fit Products/TRU-WELD  
 Trufrom Equipment, Inc.  
 Tuttle Manufacturing  
 U.S.A. Fastener Group Manufacturing Div.  
 Ulbrich of California, Inc.  
 Umeta of America  
 UniMetal Surface Finishing  
 Unistrong Industrial Co Ltd  
 United Dowel Pin Mfg. Co.  
 United Titanium, Inc.  
 Universal Punch Corp.  
 Valley Fastener Group  
 Vega Industries, Inc.  
 Vegas Fastener Mfg  
 Vertex Distribution  
 Vibrationmaster  
 Vico Products Co.  
 Videx Machine Engineering  
 Virginia Fasteners  
 Vlier Products  
 Vogelsang Corp.  
 Vulcan Threaded Products  
 W. J. Roberts Co., Inc.  
 Wenzhou Longhua Daily Electron Co Ltd  
 Wenzhou Longwan Shengjia Metal Products Co., Ltd.  
 Western Wire Products Co.  
 Willie Washer Mfg.  
 Wilson-Garner Company  
 Women in the Fastener Industry  
 Wrentham Tool Group, LLC  
 Wrought Washer Mfg., Inc.  
 Wyandotte Industries, Inc.  
 Xing Chang Fasteners Factory  
 XL Screw Corporation  
 Yellow Woods & Roads Less Traveled Co.  
 Yih Shwei Bolt Industrial Co., Ltd.  
 Your Choice Fasteners & Tools Co., Ltd.  
 Zhejiang Aozhan Industrial Co., Ltd.  
 Zhejiang Huantai Fastener Co., Ltd.  
 Zhejiang New Oriental Fastener Co., Ltd.  
 Zhejiang Qifeng Hardware Make Co Ltd  
 Zhejiang Shengrui Machinery Co., Ltd.  
 Zhejiang Taisheng Fastener, Co., Ltd.  
 Zhejiang Xiaoshan Goaling Auto Parts Co.,Ltd.  
 Zhoushan Zhengyuan Standard Spares Co., Ltd.



## DISTRIBUTOR NEWS

Fastener distributors have a reason to be excited with the **FCH Sourcing Network**. The popular online fastener sourcing network now supports direct access from The Business Edge, INxSQL, and Distribution One. Also in development is an interface to Prophet 21, the flagship ERP platform from Epicor, which is widely used in the industry.

The new interface allows FCH members to identify and upload inventory from within their enterprise data environment, and then to have automated updates pass to FCH over time, to maintain up to date listings.

"The new interface makes listing on FCH a very simple proposition for users of any of these software platforms," says FCH technical manager, Brian Musker. "And linking directly to our members' databases will provide even more benefits going forward."

The new FCH interface uses a suite of web services that support the transfer of data between users and the FCH server that has proven to be fast, secure and reliable during development trials. Users of the participating platforms who are also FCH members can use the new interface at no additional charge.

For more information contact Eric Dudas by email: [eric@fastenersclearinghouse.com](mailto:eric@fastenersclearinghouse.com) or phone 1-877-332-7836.

You can visit Fastener Clearing House online at [www.fastenersclearinghouse.com](http://www.fastenersclearinghouse.com).

# GF&D. THE PERFECT CHOICE FOR THE PERFECT FIT!



*"Keep things running smoothly with GF&D."*  
-Frankie Fitting

### YOUR #1 STOP FOR ALL YOUR GREASE FITTING NEEDS. WE OFFER:

- Grease fittings
- Couplers
- Hose whips
- The Push 'n Lube
- Bulk fittings
- Barcoding
- Poly-bagging & private labeling
- Kitting
- Clamshells

### STOCK ITEMS ARE READY TO SHIP WITHIN 24 HOURS FROM OUR STOCKING WAREHOUSES IN:

- New Berlin, Wisconsin
- Arlington, Texas
- Clearfield, Utah

**PLEASE CONTACT OUR CUSTOMER SERVICE DEPARTMENT AT 800-360-1318**



5500 S. Westridge Drive  
PO Box 510087  
New Berlin, WI 53151  
Toll free: 800-360-1318  
Fax: 262-789-8640

Certified to  
QS-9000, 3rd Ed., 1998



& ISO-9002, 1994  
Cert. #01.318.1



[www.gfdsystems.com](http://www.gfdsystems.com)

FASTENER COMPANY ACQUISITIONS COMPLETED IN THE FIRST HALF OF 2012 *continued from page 38*

On March 1, 2012, Elgin Fastener Group LLC ("EFG") purchased Quality Bolt & Screw Company. Quality Bolt & Screw, a privately-owned company, was founded in 1958 and is located in Brecksville, Ohio. The company manufactures cold-headed bolts, pins and studs for the military and general industrial markets. Quality Bolt & Screw focuses primarily on producing larger diameter (up to 1-1/4 inch) male fasteners and/or custom-engineered parts for specialty industrial applications. EFG, headquartered in Versailles, Indiana, manufactures a diverse range of cold-headed, externally-threaded, specialty and semi-standard fasteners. The company is comprised of five principal fastener manufacturing business units, with each EFG business unit producing a distinctly different product range for separate industrial applications and end-user markets. EFG is a portfolio company of Audax Group, a Boston-based private equity firm.

**Purchase price: not available**



On March 8, 2012, Tanner Bolt & Nut Corporation purchased City Sprint Safety & Supply LLC ("CitySprint"). CitySprint, a privately-owned company located in Long Island City, New York, is a specialty distributor of construction fasteners, safety products, lifting products, power tools and general hardware supplies. CitySprint specializes in providing express delivery of contractor supplies to job sites in New York City, New Jersey, Long Island and Westchester. Tanner Bolt & Nut, a privately-owned company, was founded in 1979 and is located in Brooklyn, New York. The company distributes a diverse range of fasteners, security hardware and general industrial supplies to contractors, manufacturers and government agencies throughout the great New York metropolitan region.

**Purchase price: not available**



On May 14, 2012, MacLean-Fogg Component Solutions ("MFCS") purchased Sky Manufacturing Inc. Sky Manufacturing, a privately-owned company, was founded in 1997 and is located in Commerce, California. The company manufactures bolts for the aerospace market to standard NAS, MS, AN and AS part numbers, along with customer-specific specials from a range "exotic" alloys including titanium, Inconel, Waspalloy, H-11 Vacuum Melt and A-286. MFCS is a diversified manufacturer of highly-engineered fasteners and specialty metal & plastic components with 14 manufacturing facilities in the US and Europe. The company supplies a wide range of end-user industries including automotive, heavy truck, aerospace, appliance, wind power and mining. MFCS is a division of The MacLean-Fogg Company, a global enterprise with annual net sales of \$900 million and a workforce of more than 3,200 people.

**Purchase price: not available**



On May 18, 2012, Precision Castparts Corp. (NYSE: PCP) purchased Centra Industries Inc. ("Centra"). Centra, a privately-owned company, was founded in 1974 and is located in Cambridge, Ontario, Canada. The company manufactures a range of precision-machined airframe components and assemblies in both aluminum and difficult-to-machine aerospace alloys (such as titanium, Inconel and hardened steels). The company also assembles major aircraft sub-structures and performs kit integration. Centra does not produce what would be considered a typical fastener, however, the company's products are complementary to those of PCP's Fastener Products segment and will be reported as part of this business segment. Precision Castparts is a global manufacturer of complex metal components and products serving the aerospace, power and general industrial markets.

**Purchase price: not available**



**“Searching For More Profits?”**

**“It’s Elementary!”**

**Distributor Inquiries  
Invited!**

**Choice territories  
available!**



**BRASS  
FITTINGS**



**Brass Fittings For: Industrial! • Plumbing!  
Truck! • Automotive! • OEM!**

**WE’LL BE YOUR WAREHOUSE!**

No need to stock additional inventory. We provide seamless “blind” drop shipping to your customer.

Please visit our website at:

[www.brassfittings.com](http://www.brassfittings.com)

- Compression / Flare / Pipe Fittings
- Poly Tube & Garden Hose Fittings
- Hose Barbs / Nipples / Ball Valves

For Your Free 56-Page Fittings Catalog, Contact Us At:

**Couplings Company, Inc.**

570 Bond St. • Lincolnshire, IL 60069  
Phone 847-634-8990 • Fax 847-634-9282  
E-mail: [sales@couplingscompany.com](mailto:sales@couplingscompany.com)

**Light Construction Fasteners • Mill Shipments • Fast Quotes • Nationwide Services**

**HIGH QUALITY & SERVICE SETS US APART**



**INTERFAST GROUP**

**THE PROFESSIONAL'S CHOICE™**

[www.interfastgroup.com](http://www.interfastgroup.com)

2730 E. Philadelphia St. Ontario, California 91761 Toll Free: 1-800-605-1233 Fax: 909-930-2183

FASTENER COMPANY ACQUISITIONS COMPLETED IN THE FIRST HALF OF 2012 *continued from page 218*

On May 25, 2012, Precision Aerospace Components Inc. (OTC: PAOS) purchased Fastener Distribution and Marketing Company Inc. ("FDMC"). FDMC is a privately-owned holding company comprised of two wholly-owned subsidiaries: Aero-Missile Components Inc. ("Aero-Missile") and Creative Assembly Systems Inc. ("CAS"). Aero-Missile is a stocking distributor of aerospace fasteners based in Bensalem, Penn. (outside Philadelphia). CAS is a value-added distributor of proprietary and specialty fasteners based in Groveport, Ohio (outside Columbus). Precision Aerospace Components ("PAC") is a stocking distributor of aerospace quality internally-threaded fasteners. The principal operating subsidiary of PAC is Freundlich Supply Company Inc. located in Staten Island, New York.

**Purchase price: \$9.3 million**



On May 29, 2012, Gris Decoupage S.A. purchased Knipping Umformtechnik GmbH ("KUT") from LISI Group (Euronext Paris: GFII). KUT, located in Herscheid, Germany, is a manufacturer of specialty stamped and press-formed components for the automotive and electrical markets. KUT is a key supplier to numerous German automakers including: Volkswagen, Audi, Daimler, BMW and MAN. KUT employs approximately 50 people and generated net sales of EUR8.7 million in 2011. Following the transaction closing, the company was renamed Gris Umformtechnik GmbH. Gris Decoupage is a privately-owned company, located in Pont-A-Mousson, France, which manufactures specialty stamped and press-formed components for the European automotive and industrial markets.

**Purchase price: EUR4 million**



On May 31, 2012, Stanley Black & Decker Inc. (NYSE: SWK) purchased Powers Fasteners Inc. Powers Fasteners, a privately-owned

company, was founded in 1921 and is headquartered in Brewster, New York. The company is a leading supplier of mechanical and adhesive anchors for concrete and masonry applications, along with powder-actuated fastening systems used primarily in commercial construction. Powers Fasteners is projected to generate net sales of approximately \$140 million in 2012, with 90% of net sales derived from non-residential construction. Following the transaction closing, Powers Fasteners will become part of the Stanley Black & Decker Construction Do-It-Yourself ("CDIY") division's Professional Power Tools Group. The company will maintain its headquarters in Brewster. Stanley Black & Decker is a diversified global provider of power & hand tools, mechanical access solutions, electronic security & monitoring systems and products & services for various industrial applications.

**Purchase price: \$224.4 million**



On June 1, 2012, Tramec LLC purchased LRG Fastener Corporation, doing business as Continental-Aero. Continental-Aero, a privately-owned company, was founded in 1948 and is headquartered in Harrison, New Jersey. The company is a stocking master distributor of nylon insert locknuts, all-metal locknuts and finished hex nuts. The majority of the product sold by Continental-Aero is imported from Asia and the company's main stocking warehouse is located in Alsip, Illinois (outside Chicago). Following the transaction closing, the company was renamed Tramec Continental-Aero LLC. Tramec supplies a diverse range of highly-engineered components to the heavy-duty tractor and trailer markets (both OEM and aftermarket sales), along with the general industrial fastener market. Tramec is headquartered in Iola, Kansas and is a portfolio company of MacLean Investment Partners LLC, the private equity investment company of the Barry L. MacLean family.

**Purchase price: not available**

**SCREW  
AND  
SUPPLY  
INC**

**We want to be  
SPECIAL  
to you!**

**SPECIALS TO PRINT OR TO SAMPLE**

*We offer low minimum quantity requirements (5000 in most cases)  
Quick Deliveries and Reasonable Pricing*



**Socket Styles**

Socket, Low Socket (Knurled or (Unknurled)  
Button Head, Flat Head  
Cap Screw or Sheet Metal Threads  
(with or without Security Pins)  
#4 - #14 Sheet Metal  
4-40 - 1/2-13 Cap or Machine Screws  
1/2-13 Socket Products - 1000 minimum!

**Point Styles**

- Type 'A'
- Type 'AB'
- Type 'B'
- Type 'C'
- Type 'CA'
- Type 'F'
- Type 'HI-LO'
- Type 'PT'
- Type 'TT'

**Drive Styles**

- 6 Lobe
- 6 Lobe Security
- Hex
- Hex Security
- Phillips
- Square

**Head Styles**

- Flat
- Flat Undercut
- Oval
- Oval Undercut
- Pan
- Round
- Fillister
- Truss
- Round Washer
- Tri-Groove

*Materials: 1018, 1022, 4037 Alloy Steel, 18/8 Stainless Steel*

**Toll Free: 800-223-1316 or 631-567-2900 Fax: 631-567-3057**

**Email: [sales@screwsupply.com](mailto:sales@screwsupply.com) Web: [www.screwsupply.com](http://www.screwsupply.com)**

**1712 Church Street, Holbrook, NY 11741**

# MFDA'S 33RD ANNUAL SCHOLARSHIP AWARDS RUTHERFORD, NEW JERSEY - JUNE 19, 2012





7500 NEW HORIZONS BLVD.  
 AMITYVILLE, NY 11701  
 TEL: 800-645-1234  
 TEL: 631-225-6400  
 FAX: 631-225-6499  
 EMAIL: [NOVAFSTNER@AOL.COM](mailto:NOVAFSTNER@AOL.COM)  
 WEB: [WWW.NOVA-ANCHOR.COM](http://WWW.NOVA-ANCHOR.COM)

**With a shrinking global sourcing market.....  
 Here we GROW again !**

**ANCHORS • SCREWS • NUTS • WASHERS • RIVETS • PINS INSERTS • RODS**

- Acoustical Lags
- Augers (Zinc/Plastic)
- Chair Seating Anchors/Studs
- Chemical Anchors/Studs
- Coupling Nuts
- Drive Pins
- Drop Ins
- Hammer Drives
- Hollow Wall Anchors
- Lag Shields
- Lead Wood Screw Anchors
- Machine Screw Anchors
- Nylon Nail-Ins



- Plastic & Vinyl Plugs
- Pull Toggles
- Self Drills
- Set Bolt Anchors
- Single/Double Expansion Anchors
- Sleeve Anchors
- Split Drives
- Toggle Wings/Bolts
- Toggles - Plastic
- Wall Hooks
- Wedge Anchors
- Threaded Rod



**• COMPLETE STOCKING  
 INVENTORY OF ALL  
 COMMERCIAL FASTENERS  
 • MILL QUOTES  
 WELCOME**



**ANCHORS ANCHORS ANCHORS**

Conforming to all government specifications....AN, MS, NAS and commercial  
 J.I.T. Delivery  
 Direct Importing  
 In-House and On Line shopping  
 Certs on Request  
 Full Lot Traceability

Standard and Metric Specials  
 All materials, grades & finishes  
 Special fabrication  
 Bar Coding

**PACK IT**



**BULK IT**



**or**

**CONTAINER IT**



**REGIONAL WAREHOUSES IN NY, SC AND GEORGIA  
 GUARANTEED CUSTOMER SATISFACTION**

# Threaded Inserts



## For Metal:

- Solid**
- Carbon and stainless steel designs
  - Unified: 4-40 to 1-8; Metric: M3 to M20
  - Standard OD threads...install without special tools
- Coil**
- Unified: 2-56 to 1-1/2-6; Metric: M2 to M39
  - Extensive inventory of STI taps, drills & installation tools
  - Prepackaged kits and assortments

New!  
Now Stocking  
Coil Inserts

## For Plastic:

- Press Inserts**
- Press-in installation...install cold
  - Flush, flanged & reverse slot designs in brass & stainless
  - Unified: 0-80 to 3/8-16; Metric: M3 to M6
- Ultrasonic**
- Tapered design in single & double vane
  - Straight design in flush and flanged configurations
  - Unified: 2-56 to 3/6-16; Metric: M2.5 to M6

## For Wood:

- Knife Thread**
- Superior holding power in hard woods, like oak, maple, & cherry
  - Unified: 4-40 to 3/8-16; Metric: M3 to M8
  - Available in brass & stainless steel
- Hex Drive**
- Inexpensive solution for soft woods, composition board, & MDF
  - Flush & flanged designs; multiple lengths
  - Unified: 8-32 to 5/16-18; Metric: M6 & M8

Seven regional warehouses with extensive inventories speed delivery and minimize freight costs.

Call or visit our website today for more information:  
(800) 234-5613 • [www.ezlok.com](http://www.ezlok.com)

# EZLOK

## DISTRIBUTOR NEWS

**ND Industries**, a trusted name in pre-applied fastener adhesives and sealants, expands their in-house inspection and sorting capabilities with the addition of world-class equipment from Linear GS. With this new equipment, customers of ND Industries can now use one company for fastener inspection, processing, and packaging.

Customers who utilize this new opportunity will see lower shipping and handling costs by having ND Industries conduct complete part inspections at the same location that it performs the fastener processing. No transportation time also leads to a quicker part turnaround. Less part handling means that there will be fewer touch marks and less potential for part damage.

ND Industries' new Linear GS Inspection machines can inspect various fastener dimensional tolerances including shank length and head diameter. Fasteners can be sorted for defects such as bent shanks, missing threads, recess fills, broken punch formations, and the presence of foreign material.

ND has processing centers strategically located across the United States, additional facilities in China and Taiwan, and licensees throughout the world. Inspection and sorting is currently available at the following ND Industries locations: Clawson, Michigan; Northbrook, Illinois; Twinsburg, Ohio.

More information about ND Industries can be found online at [www.ndindustries.com](http://www.ndindustries.com). To learn more about Linear GS, visit [www.LinearGS.com](http://www.LinearGS.com).

THE  
DISTRIBUTOR'S

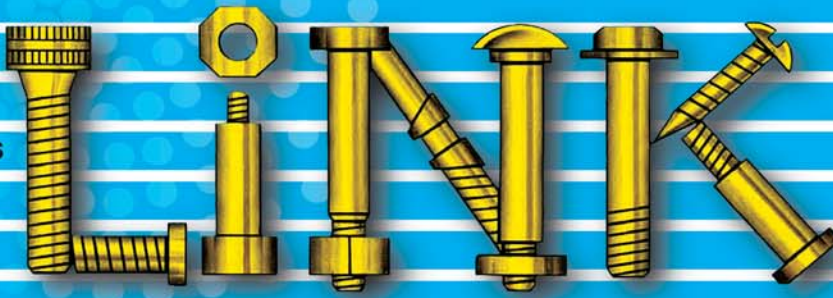

**NEW**  
DIGITAL MAGAZINE  
[www.linkmagazine.com](http://www.linkmagazine.com)

# BENEFITS OF ADVERTISING

**GET THE MOST OUT OF YOUR ADVERTISING!  
ALL LINK MAGAZINE ADVERTISERS WILL RECEIVE...**

**Free Online Edition Ad**

**Free Web Directory Ad**

**Free Website Hyperlinking**

**Free Feature Article**



**LINK MAGAZINE NOW OFFERS A *FULL DESIGN SERVICE*  
FOR ALL OF OUR PRODUCTS - AT COMPETITIVE RATES!  
EXPLORE YOUR POTENTIAL AND CONTACT US FOR DETAILS.**

**RESERVE YOUR SPOT NOW! CONTACT US FOR ADVERTISING OPPORTUNITIES**

phone 1.800.356.1639 or 239.643.2713 | email [maryann@linkmagazine.com](mailto:maryann@linkmagazine.com) or [tracey@linkmagazine.com](mailto:tracey@linkmagazine.com) | web [www.linkmagazine.com](http://www.linkmagazine.com)

FASTENER COMPANY ACQUISITIONS COMPLETED IN THE FIRST HALF OF 2012 *continued from page 220*

On June 4, 2012, Building Material Distributors Inc. (“BMD”) purchased Master Fasteners International LLC (“Master Fasteners”). Master Fasteners, a privately-owned company, was founded in 1994 and is headquartered in Long Beach, California. The company is an importer and stocking master distributor of pneumatic fasteners, including brads, staples and nails. Master Fasteners sells to STAFDA members and OEMs / end-users throughout the United States. The company has a Memphis, Tennessee branch which operates under the name Fastener Source. BMD, an employee-owned company, was founded in 1943 and is headquartered in Galt, California. The company is a wholesale distributor of specialty building materials focusing on the Western United States.

**Purchase price: not available**



On June 13, 2012, Elgin Fastener Group LLC (“EFG”) purchased Northern Wire LLC. Northern Wire, a privately-owned company, was founded in 1970 and is located in Merrill, Wisconsin. Northern Wire is one of the largest wire-formers in North America, operating from a 100,000 square foot facility with 140 employees. The company also has cold-heading, machining and welding capabilities, along with a full complement of secondary operation machinery and its own plating facility. EFG, headquartered in Versailles, Indiana, manufactures a diverse range of cold-headed, externally-threaded, specialty and semi-standard fasteners. The company is comprised of six principal fastener manufacturing business units, with each EFG business unit producing a distinctly different product range for separate industrial applications and end-user markets.

**Purchase price: not available.**



On June 18, 2012, Validor Capital LLC completed the purchase of EDSCO Fasteners Inc. (“EDSCO”). EDSCO, a privately-owned company, was founded in 1985 and is headquartered in Denton, Texas. The company is a premier fabricator of anchor bolts and anchor bolt cage assemblies used in large steel structures such as power transmission, wind power and cellular towers. In addition to the main facility in Denton, Texas, EDSCO has branch operations in Charlotte, North Carolina and Spanish Fork, Utah (near Provo). Validor Capital is a New York-based private equity firm which focuses on acquiring majority equity stakes in small to middle market manufacturing and industrial service businesses with high-quality senior management.

**Purchase price: not available**



On June 20, 2012, MW Industries Inc. purchased Hi-Tech Machine Inc. Hi-Tech Machine is a privately-owned company located in Concord, North Carolina. The company manufactures precision-machined steel components for the medical, aerospace, military / defense and hand power tool markets. Following the transaction closing, the operations of Hi-Tech Machine will be consolidated into MW Industries’ Springmaster Division located in Greer, South Carolina. The founder / seller of Hi-Tech Machine will join the Springmaster organization to integrate the existing business base and drive growth opportunities. MW Industries is headquartered in Logansport, Indiana and is a manufacturer of engineered mechanical components, including highly-engineered springs, specialty fasteners, machined components, precision stampings and custom wire forms to name a few.

**Purchase price: not available** 



## DISTRIBUTOR NEWS

### Advanced Poly-Packaging

believes listening is the most important tool we can offer, so our custom-engineered products reflect your application, not the other way around.

The UCS-2400 is a 3-in-1 system that incorporates a vibratory parts counter, net-weight and check-weigh capabilities. Manufacturers often need to switch applications and this system will quickly changeover as quickly your production schedule! The T-1000 Advanced Poly-Bagger is fast, accurate and easy to operate.

If the UCS-2400 is a little more than what you need, check out the UC-2400 Vibratory Parts Counter, designed for piece count. We had bulk counting of lighter parts or smaller batches in mind with the US-9000 Automatic Vibratory Bowl Net-Weigh/Counting Scale.

Advanced Poly-Packaging offers a one-stop-shop approach that includes everything from a free product evaluation and concept creation by our professional graphic design team to producing and inspecting that finished product – all in our facility in Akron, OH. We also have dozens of stock bag sizes and overstock bag available for shipment within 24 hours.

Contact Advanced Poly-Packaging at 1-800-754-4403, or visit their website at [www.advancedpoly.com](http://www.advancedpoly.com).

## Do You Bag Fasteners?

We have solutions for low and high volumes!



### T-375 Tabletop Bagger

- Smaller Quantities
- Next Bag Out™ printing
- Options to fit your application

### US-5500 System

- Net-Weigh/ Counting Scale
- Designed for kit packaging
- LEDs indicate which part to load



### UCS-2400 System

- 3 in 1 Parts Counter, Net Weigh & Check Weigh
- Quick and Accurate
- Brand New!

### US-9000 System

- Automatic Vibratory Bowl Net-Weigh/ Counting Scale
- Bulk counting
- Lighter parts/smaller batches



### Bags!

- Custom Bags
- Dozens of stock sizes
- Blanket prices (saves money!)

SEE US AT  
BOOTH  
1048

 **Advanced Poly-Packaging, Inc.**

1331 Emmitt Road • Akron, OH 44306 • USA: 330-785-4000 • fax 330-785-4010  
1-800-754-4403 • sales@advancedpoly.com • www.advancedpoly.com

## The Importance of Corporate Records

Corporations are created and maintained to insulate owners from liability. Even with sole shareholders, the corporation can protect the owner from liability. The lack of corporate record books can be used as a factor in piercing the corporate veil.

### A Tort Case

A primary purpose of doing business as a corporation is to insulate stockholders from unlimited liability for corporate activity. Limited liability will ordinarily exist even when the corporation is closely held or has a single shareholder. *Peetoom*, 334 Ill. App. 3d at 526.

Courts can disregard corporate protection. For instance, a court may disregard a corporate entity and pierce the veil of limited liability where the corporation is merely the alter ego or business conduit of another person or entity. The doctrine of piercing the corporate veil is an equitable remedy; it is not itself a cause of action but rather is a means of imposing liability on an underlying cause of action, such as a tort or breach of contract." *Peetoom*, 334 Ill. App. 3d at 527.

### A Contract Case

In a breach of contract case (*Macaluso v. Jenkins*, 95 Ill. App. 3d 461), the court looked to the absence of records as a veil piercing factor.

With respect to the factors used to determine whether piercing the corporate veil was appropriate, the trial court found that the following factors weighed in favor of doing so: inadequate capitalization, failure to observe certain corporate formalities, failure to pay dividends, operation of the corporation without a profit, commingling of corporate and personal assets, a non-functioning officer or director, insolvency of the corporation, and absence of corporate records.

### Tax Requirements

Owners of closely held companies tend to infuse or withdraw money into and from their companies. The question becomes, is the transaction a loan or is it a constructive dividend? Shareholders receiving loans must properly record the loan. If the loan is not properly recorded in the corporate minutes, the loan may be deemed as a constructive dividend. What does this mean for the shareholder? The shareholder may be

forced to pay ordinary income taxes on money that would otherwise be nontaxable.

There is also the issue of setting fiscal years. Though the issue of timing can seem relatively insignificant, for some companies that have busy seasons and slow seasons, the timing of the tax year can radically reduce their tax liability. In addition to the requirements based off the Internal Revenue Code and IRS procedures, shareholders and corporations must document the change of the fiscal year in their records as well.

### Company use of Personal Possessions

Many owners of closely-held companies intermingle their own possessions into their companies. The line between what is company owned and what is personally owned may become blurred and indistinguishable from each other, even to the corporate owner. Vehicles, tools, equipment, and the like commonly used in company and personal settings are prone to this problem. Shareholders giving loans to or borrowing equipment from the corporation must properly record in the minutes the ownership of the equipment. If the loan or equipment is not properly recorded here, the loan or property may be interpreted as property of the corporation during litigation.

**Corporations are created and maintained to insulate owners from liability. The lack of corporate record books can be used as a factor in piercing the corporate veil.**

### Conclusion

Corporations tend to move large volumes of money in terms of loans, leases, purchases, and distributions, etc. In most cases, corporate finance dwarfs individual finances. When corporate resolutions are not adopted or memorialized as minutes, personal liability can result. When personal liability results from company debts and finances, the overrun can bankrupt a business owner's personal finances in the process.

One of the most effective ways to protect clients is to keep an updated corporate record book. An updated corporate record book shows that formalities have been observed, which is what is legally required. It shows proper resolutions were adopted that shed liability in certain circumstances and corporate records reduce decisions to writing. Having this level of organization is critical in business and specifically required of corporations under state law. The Center for Financial, Legal, and Tax Planning, Inc. maintains a number of corporate record books for various corporations and companies. 



# SECURITY FASTENERS



**Allegheny is dedicated to providing the most comprehensive line of security nuts, bolts and screws in the industry including the patented Tampruf™ fasteners. We carry a complete line of Spanners, 6-Lobe & Hex Sockets and One-way Screws for a variety of applications.**

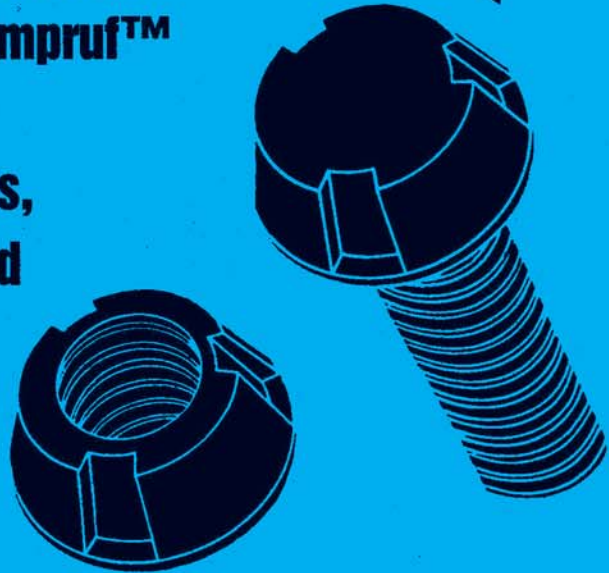

**Tel: 800-543-2614 Fax: 800-543-2615**

*16216 Gundry Avenue, Paramount, CA 90723*

**DISTRIBUTORS & MANUFACTURERS WORKING TOGETHER TO SOLVE PROBLEMS FOR OEMS WITH BLINK RIVETS** *continued from page 48*

After further review, the OEM's assembly and industrial engineering staff felt certain that blind rivets would offer the necessary speed of assembly, reliability and permanence they required. In addition, the low capital expenditure and labor cost associated with blind riveting also made it a highly attractive solution. They consulted a knowledgeable distributor who sold products based on what they referred to as their "solutioneering" abilities as well as their access to rivet manufacturers who could provide the necessary design support.

In this case, the distributor and rivet manufacturer worked together to solve the problem at hand.

The distributor's solution was to provide an access hole that could be drilled by the OEM at the same time as the joint hole as seen in diagram.

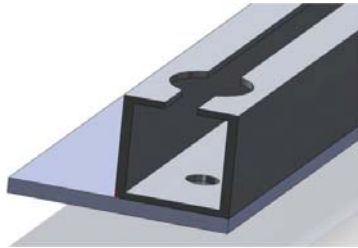

Figure 4 - Distributors Solution:  
Nose Piece Access Port

However, while the distributor had successfully resolved the issue of how the rivet could access the joint hole, other challenges surfaced.

The nose piece wasn't long enough to reach the primary material. Although this was technically an easy fix since the nose piece length could be increased, doing so would require a longer mandrel for the riveting tool jaws to properly pull the mandrel to set the rivet. Nearly all blind rivets have a mandrel protrusion length of between 1.00"~1.10", which is not long enough to engage the jaws.

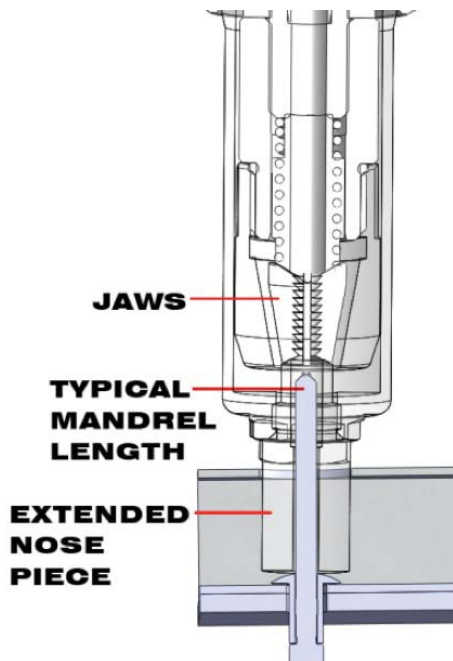

Figure 5 - Insufficient Mandrel Length:

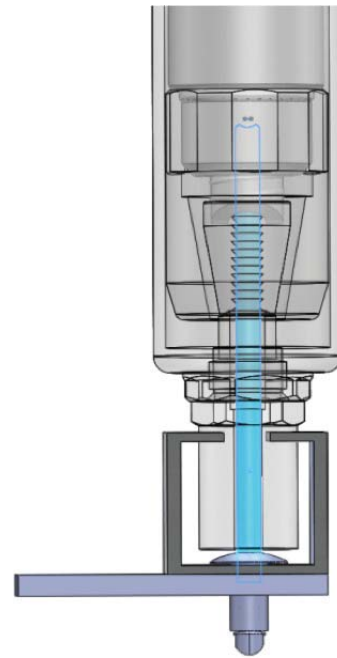

Figure 6 - Manufacturers Solution:  
Custom designed nose piece  
Increased Mandrel Length

The rivet application engineer measured the access port to determine what the proper nose piece length would be. Then, the rivet manufacturer calculated the necessary mandrel length and mocked up samples of the nose piece – revising the rivet design based on these results. With some trial and error, a final design was submitted to the customer along with samples, which was approved shortly after as the right solution.

### Win-Win-Win in Blind Rivet Distribution

This hand-in-hand, seamless support gave the OEM a cost effective assembly method that helped them meet their production goals. The distributor was also highly regarded as a solutions provider, which resulted in the sale of many millions of rivets as well as other fasteners. At the same time, the rivet manufacturer was able to create a pinnacle product with this solution that will provide a reliable source of business well into the future. ⬡



**THE SOLUTION:**  
-A RESOURCEFUL DISTRIBUTOR  
-AN INNOVATIVE & SUPPORTIVE  
RIVET MANUFACTURER  
-EXTENDED NOSE PIECE  
-LONGER MANDREL

# NOW STOCKING!

## LARGE DIAMETER BOLT BLANKS

### We CUT We THREAD We SHIP in 1-2 Days!

- 1/2" to 2 1/2" Diameters
- Lengths up to 30"
- Hot Dipped Galvanizing
- Plating Services
- A193
- B7
- A325
- A490
- A449
- Grade 5 & 8

[superiorbolt.com](http://superiorbolt.com)

**SUPERIOR  
BOLT  
& NUT MFG**  
PHOENIX, ARIZONA

Call Us For YOUR  
Weekly Specials!

Mill Orders Ship in 2 Weeks

**602-841-8100**

[johnr@superiorbolt.com](mailto:johnr@superiorbolt.com)



#### THE BIGGEST ROI A FASTENER COMPANY CAN GET SADLY GOES UNDER EXPLOITED *continued from page 70*

Shortly thereafter I was flown to Rockford for two weeks' exposure to manufacturing and applications engineering. They had no formalized way to train new employees, so they just wrote down a series of departments and told the department managers I was coming and to show me what they could or what I asked to see. I was the human sponge of fastener technology. It was an exciting and enlightening experience.

When I returned to Arlington, Texas, I decided learning in this unorganized, unstructured way was too difficult and not many people would do what I was doing to gather fastener technology knowledge. I decided to do something for future employees that had not been done for me. I wrote a 200-page training manual on fastener technology based on what I had raked together and learned in two weeks spent in fastener manufacturing and engineering.

The book was typed up by staff in Rockford, copyrighted, and used for at least the next 20 years as one of the primary training tools for new hires in technical sales and engineering. I benefited greatly from the experience of gathering the information and writing the book. This experience formed the foundation upon which I built the broad knowledge of fastener technology I have today.

The point of this story is that there was no industry

training available in the 1970s; therefore, it took many years for a person to become adept at fastener technology. Because fastener technology was passed on as tribal knowledge, there was no guarantee what was learned was correct. Unfortunately, not a lot has changed in since in the way most fastener companies approach training. It still appears to be primarily OJT.

The good news is that organized fastener technology training is available today to every fastener company in North America through the joint efforts of the Fastener Training Institute® (FTI) and the Industrial Fasteners Institute (IFI). Currently there are two different programs available, Fastener Training Week, and the Automotive Fastener Technology Program.

The FTI is an organization created by the members of the Los Angeles Fastener Association (LAFA), now Pacific-West Fastener Association, in an effort to convert their highly successful Certified Fastener Specialist™ program into a nationwide program. The original west coast program has turned out more than 300 Certified Fastener Specialists (CFS) over the last 14 years. The original program consisted of six individual one day seminars with a different one offered approximately every other month, so it took more than a year to complete the program.

*please turn to page 233*



# NEW ENGLAND FASTENER DISTRIBUTOR'S ASSOCIATION 2012 SCHOLARSHIP GOLF OUTING - JUNE 5, 2012



See us at the  
Natl. Ind. Fast. Show  
Booth # 734



Made in the USA  
since 1928

DFARS, RoHS  
& REACH  
compliant



## Who said Washers have to be Round or Flat?

PRICE,  
DELIVERY &  
ORDERING  
ONLINE

53 Styles of Washers  
available online  
and  
capacity to  
manufacture  
any shape  
to fit  
your application!



800-634-2356

[www.seastrom-mfg.com](http://www.seastrom-mfg.com)

### THE BIGGEST ROI A FASTENER COMPANY CAN GET SADLY GOES UNDER EXPLOITED *continued from page 231*

Because of my struggle to learn fastener technology, as explained above, I was thrilled to be asked to be one of the instructors in the original CFS program. When I assumed my current position as Director of Engineering Technology for the IFI in January of 2007 I knew one of the things I wanted to do for the fastener industry was to help improve the availability of fastener technology training for all of North American fastener suppliers to improve the breadth and depth of knowledge throughout our industry.

The IFI leadership agreed to support a cooperative effort between the IFI and FTI to adapt the west coast CFS program into a nationwide program that would be condensed into one week. The result of that agreement and joint effort lead to the creation of the Fastener Training Week program starting in the summer of 2009. It is now conducted every summer at the IFI Headquarters in Independence, Ohio and in Los Angeles each spring.

The following are the topics covered during the five day program:

#### **Fastener Training Week Content**

- Consensus Standards Organizations
- Torque Tension Demonstration
- Acquiring Fastener Specifications
- Quality Assurance Systems
- Fastener Terminology
- Thread Specifications and Gaging
- Certifications, Test Reports and Lot Traceability
- Fastener Testing and Inspection Equipment
- Hands-on Equipment Experience
- Advanced Print Reading and Tolerances
- Fastener Material Standards
- Fastener Dimensional Standards
- Machine Screws and Stainless Steel Standards
- Metric Fastener Standard Dimensions, Tolerancing and Threads
- Hydrogen Embrittlement in Threaded Fasteners
- Plant Tour Day
  - o hot heading and cut threading facility
  - o surface coatings facility
  - o independent laboratory facility

*please turn to page 234*



**THE BIGGEST ROI A FASTENER COMPANY CAN GET SADLY GOES UNDER EXPLOITED** *continued from page 233*

The CFS instructors include Carmen Vertullo, ME, CFS and Lead CFS Instructor, Salim Brahimi, Chairman of American Society for Testing and Materials (ASTM) F16, Bengt Blendulf of EduPro U.S., and myself.

Based on feedback from some automotive fastener engineers who attended the Fastener Training Week in 2010, a more in-depth two-day fastener technology program specifically related to automotive fasteners was initiated in 2011 and is now scheduled for each spring in the Detroit, Michigan area.

**Automotive Fastener Technology Program Content**

- Fastener Tightening Technology
  - o An overview of the fundamentals of fastener tightening
  - o Torque – Angle Tightening Technology
  - o Ultrasonic Tightening Technology
- Failure Analysis
  - o Responding to product complaints
  - o Fundamentals of fracture and failure
  - o Types of failure and how to identify them
    - Ductile fracture modes
    - Brittle fracture modes
    - Tensile failure
    - Torsional failure
    - Fatigue failure
    - Thread failures
    - Hydrogen related failures
      - Hydrogen embrittlement (internal causes)
      - Stress corrosion cracking (external causes)
- Metric Thread Technology
  - o Applicable standards
  - o Thread class calculations (6e and 6E)
  - o Inspection requirements and applicable gages
- Fastener Metallurgy
  - o Common carbon and alloy steels
  - o Progression and properties of metallurgical structure
  - o Heat treating basics
    - Through hardening vs. surface hardening
    - Quench and tempering
    - Case hardening

- Induction hardening
- Fastener Coatings and Surface Finishing
- Plant tours
  - o Heat Treat Facility
  - o Automotive Coating Facility

*Below are some questions I would like to answer for readers:*

**Q1. Are these programs any better than OJT?**

A1. Attendees have had from one month to 30 years of fastener industry experience. Those with five years and more all state that they learned more in the one week or two day program about fastener technology than they had learned since they have been in the industry.

**Q2. How do we know these programs are any good?**

A2. Since 2009 about 170 students have participated in these programs and when surveyed at the end of each program almost 100% said they would recommend to their managers that their associates should also attend these programs.

**Q3. What is the reference to ROI in the title about?**

A3.1 Customers respect suppliers who are technically astute and can help them with fastener technology questions. Landing one new customer, because your people are more knowledgeable than your competition, will quickly off-set the cost of training.

A3.2 More knowledgeable employees make fewer errors. In the fastener industry one error can easily exceed the cost of training. You will never know the value of the errors that do not happen, but the more people you employ who are well trained the fewer costly errors your company will have to absorb over time.

A3.3 The more you invest in excellent fastener technology training for your staff the greater your return will be in terms of more business and fewer errors. The training is paid for one time, but the return to the organization continues to pay off the longer the employee stays with you.

*please turn to page 236*





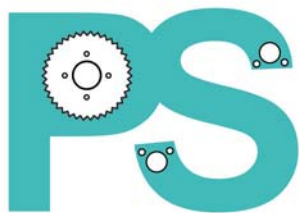

**PRECISION SPECIALTIES, LLC.**

- ★ Spring Washers
- ★ Threaded Inserts
- Clevis Pins
- Retaining Rings
- Shaft Collars
- Locknuts
- Lockwashers
- Machine Keys
- Woodruff Keys
- Grease Fittings
- Spring Pins
- O-Rings
- Terminal Cups
- Cotter / Hitch Pins
- Plastic Fasteners
- Shims

**AUTHORIZED FACTORY MASTER DISTRIBUTOR!**

[www.precspec.com](http://www.precspec.com)

★ ★ ★ ★ ★  
**PRECISION SPECIALTIES  
 SIMPLY THE BEST!  
 FOR OVER 25 YEARS**



Oetiker Clamps



Threaded Inserts



Spring Washers



Self-threading Nuts



CALL 901-854-5640 ★ FAX 901-854-5702

**SIMPLY THE BEST... PRODUCTS, PROFESSIONALISM & SERVICE... FOR OVER 25 YEARS**  
 P.O. BOX 1808 ★ COLLIERVILLE TN 38027 ★ EMAIL: SALES@PRECSPEC.COM



**CRESCENT MANUFACTURING  
 PROUDLY MADE IN THE USA**

**50 YEARS OF EXPERIENCE TO BACK OUR  
 PRECISION PRODUCTS**

**QUALITY**  
 MIL-I-45208A, MIL-STD-45662A,  
 ISO 9001:2008 and AS9100 CERTIFIED,  
 QSLM CL2A and CL3A

**COMPLIANCE**  
 DFARS, ROHS, REACH COMPLIANT &  
 ITAR REGISTERED

**MIL SPEC FASTENERS**  
 MS, AN AND NAS

**COMMERCIAL PARTS**

**METRIC FASTENERS**  
 STANDARDS ARE READILY AVAILABLE BUT  
 NOT LIMITED TO DIN, JIS, ISO, AND IFI (ASME)

**KWIK THRED**  
 SELF-CLINCHING STUDS

**RUSH ORDER FULFILLMENT AVAILABLE**

**BETA/BETA-PRO**  
 MINIATURE THREAD FORMING SCREWS

**ENGINEERED SPECIALS**

**SIZES 00-5/16 OR M1.4-M8**

**POSSIBLE LENGTHS THROUGH 3 INCHES**

**NO JOB TOO SMALL**  
 1M MINIMUM ON MOST ITEMS

**NO JOB TOO LARGE**  
 CAPABILITY TO PROVIDE PARTS IN THE  
 MILLIONS

**CUSTOMER SATISFACTION IS PRIORITY ONE**

**CHECK THE WEB FOR STOCK AVAILABILITY  
 AND OUR MILITARY PARTS LIST**

700 George Washington Turnpike, P.O. Box 1350, Burlington, CT 06013 USA  
 Phone: (860) 673-2591 Fax: (860) 673-5973 [www.crescentmanufacturing.com](http://www.crescentmanufacturing.com)

**Q4. What feedback do you get from owners and managers who have sent more than one participant over the years?**

A.4.

"Sending our employees for training tells them that what they are doing in our company is important and that we are willing to invest in them."

**Cathleen Law, Ababa Bolt**

"CFS training is one of the absolute best investments we can make in our people and in our business. Our folks consistently return from the training week enthused and appreciative of the knowledge they've gained and the priority we've placed on equipping them to do their job and serve our customers. A heartfelt thank you to Carmen, Joe, Salim and everyone involved in CFS. It's a fantastic program taught by true industry experts."

**Russ Doran, Timberline Fasteners**

"Furthering your fastener education is the best investment you can make in your company and for your customers. Here at Brighton Best International, we value our distributors and we make sure our staff is formally trained in all aspects of the fastener industry, which includes attending the CFS training program. Suppliers and distributors face many challenges in a competitive market, so having formal training in our craft will help us gain that extra edge."

**Rosa E. Hearn, Brighton Best International—Los Angeles**

**Q5. What do attendees have to say about the program?**

A.5.

"Great. Well worth my time and money. The instructors are very dedicated to the improvement and education of the industry. I have always worked in management. I can now look up specs and know where to go for information."

"This was a wonderful learning experience for me. My plan is to continue to get more fastener and technical training for my staff and myself. You have to be proud of all you have done to improve the professionalism of the industry. Thank you for sharing your knowledge and experience; I know each one of us in the training learned a

great deal."

"The CFS program drastically shortened my learning curve regarding fastener specifications. This program is a great addition to my experience."

"The course helps you understand the language of the industry. I have been in this business for two years, and I had no idea prior to taking this course how high tech the business of (seemingly) low tech parts can be. What goes into manufacturing them is incredibly precise and complex not to mention interesting. There is no way anyone would fully understand this business without that course. By the second day, I had already resolved a few (prior) customer problems. I also found out how this can help us with corrective actions in the future; this alone will probably pay for the course."

**Q6. Where can I get more information about the Fastener Training Institute/IFI training programs?**

A6. [www.fastenertraining.org](http://www.fastenertraining.org)

I am very excited about the strides that have been made over the last few years in making professional fastener technology training available to our industry. As explained at the outset, I learned the hard way and would have loved to have gotten a head start by going to one or both of these programs.

That said, I am disappointed at the fact that more management teams are not taking advantage of these valuable programs. We are averaging about 25 attendees per program out of an industry that is estimated to have more than 50,000 employees. Also as stated at the outset of this article these great programs continue to be sadly under exploited.

It is my hope for the fastener industry that more management teams will take this message to heart and start taking advantage of these training programs for the good of your companies and the good of the fastener industry. As a training method OJT is no match for a professional fastener technology program. When running my own business for 28 years I told my staff, "I hate spending money, but I love to invest in this business." There is no better return on investment a manager can make in their business than providing good training to their staff. 



## DISTRIBUTOR NEWS

**Quantum Storage Systems**, announces its industrial strength plastic carts, in stock for immediate shipment.



These durable, rugged carts are ideal for transporting tools and supplies. They are heavy-duty, with a 550 lb. load capacity, and come standard with 2 swivel and 2 rigid heavy-duty casters for easy control during movement. Choose from 2-shelf and 3-shelf models. Select tray or flat top shelf.

Contact Quantum toll-free at 1-800-685-4665, email: [sales@quantumstorage.com](mailto:sales@quantumstorage.com) or [www.quantumstorage.com](http://www.quantumstorage.com).

\* \* \*

**Quickscrews® International Corp** is stocking a new screw called the Spiral Point Funnel Head Screw that is made for a variety of different woods.



The screw has unique features that allow the screw to drive into most materials without a pilot hole. The head sinks flush and stops right below the surface

Visit [www.quickscrews.com](http://www.quickscrews.com) for more information.

**Unbrako**  
BUILT FOR LIFE.

## WHAT YOU BUILD IS ONLY AS GOOD AS WHAT HOLDS IT TOGETHER.

Your application demands a fastener which outperforms all others. We build our products for life, to help you build your products for life. What's holding your product together?

Higher Min ULT Tensile  
10,000 PSI stronger than industry standard

Compound Fillet Radius  
Doubles fatigue life at critical head-shank juncture

Wide Radius Threads  
Maximizes fatigue resistance where it's needed most

3R (Radiused Root Runout)  
Increases fatigue life up to 300%

E Code "Lot Code" Markings  
The ultimate in fastener traceability



**INTERFAST**

Exclusive Master Distributor for North America  
[www.unbrako.ca](http://www.unbrako.ca)

For Canada call: 1-800-263-6167

For USA call: 1-877-669-9024



THE NATIONAL MAGAZINE FOR FASTENER DISTRIBUTORS

# HAVE YOU SEEN US ONLINE?

Read the latest issue of Link Magazine online at  
[www.linkmagazine.com](http://www.linkmagazine.com)

COMPUTER INSIGHTS DOES IT AGAIN! FREE THE BUSINESS 2.0 SYSTEM AT NIFS VEGAS *continued from page 90*

# The BUSINESS EDGE 2.0

## FREE iPad 3s

The **BUSINESS EDGE 2.0** will be demonstrated at the show. Computer Insights will be taking tentative orders (letters of intent) on the show floor. Any company that approves a letter of intent to purchase **The BUSINESS EDGE 2.0** by the end of the show will receive a FREE iPad 3. In order to receive the iPad 3, the company must finalize the order before December 31, 2012. There is no limit to the number of companies that can receive the iPad 3.



## The BUSINESS EDGE 2.0

The **BUSINESS EDGE 2.0** is now used all over North America by fastener and industrial suppliers. Computer Insights unique, cost effective, online methods of implementing this system are extremely effective. They have hundreds of clients and all of their focus is on the fastener and industrial supply industry. Since they only work in this very narrow market, the system that they have developed is focused on the needs of their clients. While custom programming is available, it is rarely needed.

## The Brighton-Best Connection

In 2010 Computer Insights, Inc. and Brighton-Best International (BBI) released the Brighton-Best Connection and now it is in use all over North America. This exclusive system allows users of **The BUSINESS EDGE 2.0** to view price and availability from Brighton-Best while they are inside **The BUSINESS EDGE 2.0**. They can also place orders with Brighton-Best from inside **The BUSINESS EDGE 2.0**. The distributors get their web discount from Brighton-Best and eliminate the need for double entry. Now BBI's customers can even get MTR's for the products that they receive from BBI with a click of a button in **The BUSINESS EDGE 2.0**.



## Vendor Managed Inventory

The system has an award winning Vendor Managed Inventory system for bin stocking at customer locations.

This is included in the base system and the scanners for capturing the data at the customer locations are as little as \$300.00. Orders can be transmitted to the distributor over the Internet and the customer automatically receives an eMail acknowledgement.

## Wireless Warehouse System

The system also has an optional Wireless Warehouse module which uses bar codes to track every movement of inventory from the moment it is received to the final shipment of the inventory. With thousands of stock keeping units, having a bar code tracking system enables near zero errors. All the labels are produced by the system and read by the system so there is very little room for human error.



## Quality System

In addition to the normal ERP (Enterprise Resource Planning) capabilities that **The BUSINESS EDGE 2.0** offers, there is an optional Quality System Module that integrates all of the major functionality required by an ISO or AS 9100 quality system. Integrating these capabilities eliminates the possibility of errors and it saves **The BUSINESS EDGE 2.0** fastener clients a huge amount of time and money.

## Great Opportunity

Denny said, "This is an outstanding opportunity to learn more about our industry leading system and perhaps even own it FREE."

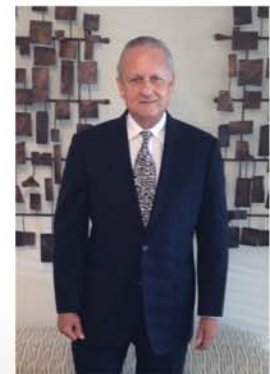

## More Information

To find out more about **The BUSINESS EDGE 2.0** or to arrange a demonstration, Computer Insights, Inc. can be reached at 108 Third Street, Bloomingdale, IL 60108. Their telephone number is 1-800-539-1233, email sales@ci-inc.com and their website is www.ci-inc.com. 

# TriState

## 800.410.4558

Fax: 330.656.4175

## T9 NUT

180M PSI Proof Load

4140 Alloy Steel

Works with High Strength Bolts

Stock 3/4" - 1 1/2"

Cadmium/Yellow Plating

Hex Nuts

Locknuts

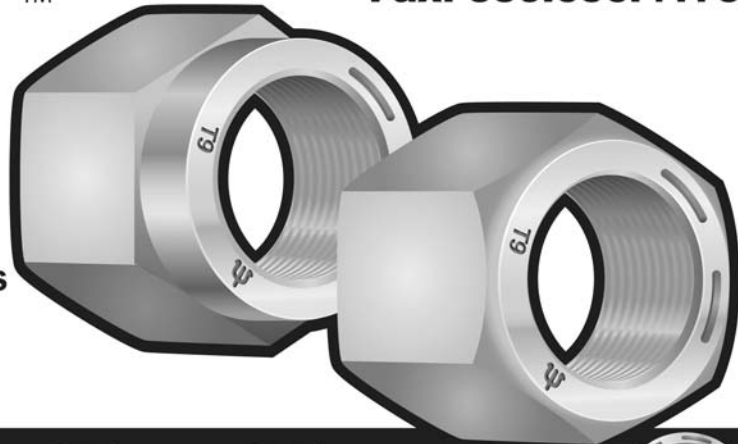

Ask about  
Hydraulic Ports  
& NPT Fittings

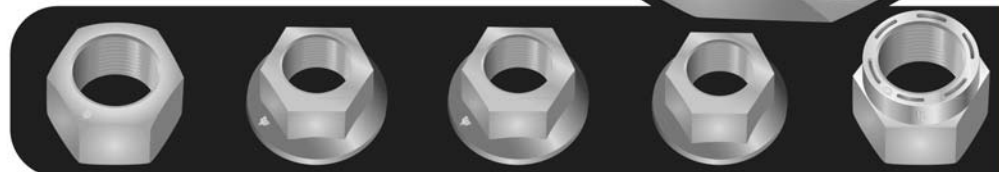

**Grade A-B-C**  
Automation  
1/4" - 2"

**Grade F**  
1/4" - 1/2"

**Grade G**  
3/8" - 3/4"

**Class 10**  
Metric Flange  
M6 - M16

**Grade C**  
Collar &  
Thin Collar  
5/8" - 3"

### THE PERILS OF PROSPERITY *continued from page 82*

In the Far East, fastener manufacturers see their rising labor costs adding to the woes of their export-based economies hurt by slack international demand. Mainland China's government faces yet an additional problem. Migrant workers have become restive. They account for a large portion of the work force in China's special economic zones—coastal areas with market economies. Harsh working conditions, official corruption, repressive social policies like the one-child rule, and their government's efforts to cool a real estate speculation threaten their Communist rulers whose key concern is maintaining political power. So, fastener makers... don't expect sales to Mainland China's superheated economy to grow at their previous pace.

Adding it all up, FedEx Corp. in April reported a nine percent drop in international shipments through its main Memphis hub, showing the European slowdown is deepening and another is starting in Asia. In light of these trends, what should fastener makers and distributors be doing NOW to prepare for a less torrid tomorrow? How should astute fastener executives protect themselves from what looks like an approaching thunderstorm?

### *Steps Needed for Tomorrow's Survival*

Wherever located, fastener producers who best meet their customers' pricing requirements will be the survivors when the thunder is upon us. This means preserving cash by building fortress balance sheets, training executives to

execute faster, and motivating workers to improve productivity. Together, these efforts will result in the lower per-unit costs needed to meet customers' price demands, ensuring survival in a flat or declining markets that are on the horizon.

Astute fastener suppliers are now taking sequential steps to prepare. First, they define and focus on core markets and products, prune product lines, and keep only the most profitable ones with the greatest potential growth.

Second, they assess their strengths and weaknesses honestly. Through market analysis and sales force reports, they conduct an external competitive survey of customer demands and competitors' strengths to determine where their greatest opportunities lie. They follow-up with a rigorous review of internal costs and productivity, to define strengths and weaknesses, figuring how best to prune costs and keep customers happy.

There is usually an overwhelming response to an internal Audit of employees, supervisors, and mid-managers when done by an impartial outside expert with no turf to protect. Staffers happily offer a host of good suggestions for improving operations and cutting costs because they often have been frustrated by perceived top management indifference to inefficiencies which fly in the face of daily operating realities. Together with productivity and cost data, the Audit enables a company to pinpoint its current competitive position, and plan what must be done to improve it.

## All Squirters™ Improve Constructability

We travel all over the world training first-time users how to use Squirters™. Occasionally we encounter skeptics who find it hard to believe that squirt appearance alone can allow the iron workers to achieve such consistent results. We understand that change can be difficult. Usually with a little coaching, we turn the skeptics into believers. However, the real challenge is to convince the decision makers to specify Squirters™ in their projects. Fortunately we have many years' worth of experience and testimonials from believers to help make the case for improved constructability.

Decision makers are usually engineers, so in addition to testimonials, the GL evaluation criteria carry a lot of weight. So, we applied the same test program to some of our smaller Squirters™. As shown in table 1, the results were equally impressive. Sizes M24, M27, M30 and a new generation M36 all had confidence intervals well within a 10% range around the target tension.

Figure 1 summarizes the results from all the confidence interval tests. In this bubble chart, I plotted the mean tension achieved in the tests versus the target tension, with the size of the bubble indicating the 97.7% confidence interval. These results are truly impressive. As indicated by the slope of the line (1.0087), on average the mean tension is slightly higher than the target tension with extremely tight fit (correlation coefficient = 0.997). Again, these are the results of blind tests where the operator used squirt appearance alone to tighten the bolt with no feedback during the test. The bottom line is that all Squirters™ allow you to consistently achieve target bolt tensions and improve constructability.

**Figure 1: Sqrter™ Mean Tension vs Target Tension**

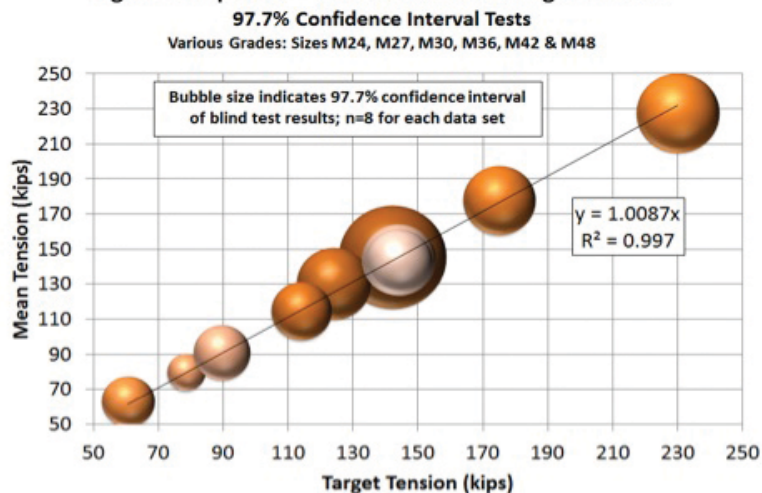



## Do Not Worry About Over-Tensioning

Some of our customers, particularly State Departments of Transportation and wind turbine manufacturers, need assurance that bolts have not been over-tensioned. This is not a problem. A feeler gage can always be used with all of our Squirters™ as a back-up inspection technique.

We demonstrated this recently with a customer who is developing a proprietary structural system designed to resist seismic activity. In addition to consistent and accurate bolt tensions, it was imperative that no bolts exceed their specified maximum tension. As shown in Table 1, our M36 10.9 Squirters™ gave a mean tension of 144 kips (versus a 143.9 target) with a 97.7% confidence interval of 5.37 kips, well positioned within their required tension range. We also provided a means of identifying over-tensioned bolts using a 0.005" feeler gage. The test data is given in Figure 2. This Sqrter™ has nine bumps; if the feeler gage cannot be inserted between two bumps, it is called a refusal.

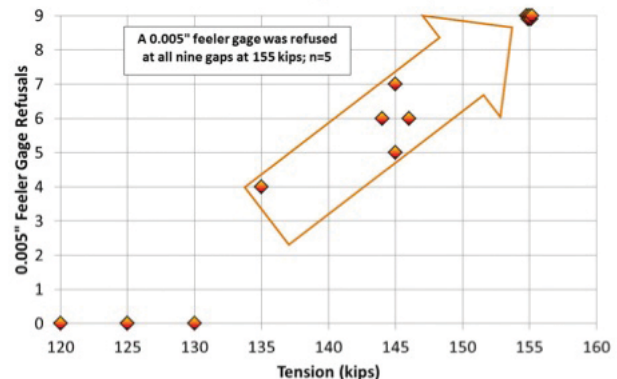
**Figure 2: M36 10.9 PL Refusals vs Tension**  
F959M Tension Range: 134 - 154 kips



At 145 kips, in the middle of the required tension range, the feeler gage was refused in roughly half of the locations. However, at 155 kips, one kip higher than their specified maximum tension, the feeler gage was consistently refused in all nine locations. This condition indicates that a fastener assembly was over-tensioned and should be replaced. The Sqrter™ gave them a cost-effective way to consistently and accurately achieve target tensions, and a feeler gage can be used as a back-up means of verifying that the bolts were not over-tensioned. Talk about constructability! 

**BRITISH METRICS**  
Importers and Distributors  
of Metric Hardware

Online Catalog

[www.britishmetrics.com](http://www.britishmetrics.com)  
P: 410-857-3990 F: 410-857-3990  
Specializing in Metric and European Products

#### THE PERILS OF PROSPERITY *continued from page 239*

As a result of their internal analyses, many fastener executives often find they must handle three problem areas to capitalize on its internal strengths. These include:

- Freeing senior management time so they can focus on long-term goals. As the problems of the organization come into focus, senior managers can learn in special training sessions how to relate their activities to their major key goals, so they can be effectively concentrate on critical matters while delegating the hum-drum to back-office staffers. (SEE: "Why Isn't Your Bottom Line Bigger?" (*Distributor's Link*, May, 2005).
- Developing a cadre of mid-managers and supervisors who know the difference between busyness and efficiency. That can be accomplished by training efforts to show them how to focus on their productivity goals and the activities they must undertake to reach them. (SEE: "Realistic Training for Today's Realities," *Distributors Link*, Aug. 2004)
- Generating employee cooperation in meeting company efficiency goals. This can be accomplished by implementing the motivation/compensation systems needed to generate an enthusiasm for excellence. Senior executive compensation is

quite often tied to company performance. Why not tie compensation of lower-level employees to their performance and innovation as well? By sharing some of these cost-savings through pay-for-performance programs, both employees and the company benefit. (SEE: "How Employees Can Improve Your Profit Level," *Distributors Link*, Winter, 2005).

#### What is Necessary Today for Tomorrow's Prosperity

Focusing on markets with the greatest potential, shedding unprofitable products, cutting costs, and installing motivation/compensation systems to boost employee productivity and achieve company efficiency goals and are all sound strategies for executives who understand being the low cost producer in the fastener industry means success.

When Teddy Roosevelt yelled CHARGE as he thundered up San Juan Hill, he didn't have to worry whether the Rough Riders were close behind him. Similarly, no matter how well executives plan how to meet tomorrow's challenges, their charge will falter unless their employees are right behind them, sharing in their company's success. 



**Set Screw & Mfg. Co.**  
1210 St. Charles St., Elgin, IL 60120 • Ph: 847-717-3700 • Fax: 847-717-3710  
email: sales@setfast.net

## MWFA 31ST ANNUAL FASTENER SHOW MEDINAH BANQUETS, ADDISON, IL - JUNE 26, 2012





## DISTRIBUTOR NEWS

**Leland Industries Inc.** is pleased to announce the acquisition of "Canadian Threadall Limited", complete with all assets.

"Canadian Threadall Limited", a privately owned manufacturer, established in 1982 and located in Waterloo, Ontario is ISO 9001: 2008 certified and has a solid reputation for producing quality threaded products. Manufacturing from ferrous and non ferrous metals, the company provides specialized threading, bending and forming services for the concrete forming, construction and automotive industries. Products include U-Bolts, Anchor Bolts and Threaded Rod; all of which complement Leland's existing fastener portfolio. "Canadian Threadall" will continue to operate independently of Leland Industries Inc., at their existing location. All of their contact information remains unchanged.

Leland Industries Inc. continues to grow and expand its offering of domestically made fastener products.

For more information you can contact Leland Industries Inc. at 1-800-263-3393 x221 and by Fax: (416) 291-0305. E-mail: [lcarter@leland.ca](mailto:lcarter@leland.ca) or visit them at [www.leland.ca](http://www.leland.ca).

# OEM SOLUTIONS

## FROM AKRO-MILS



Whether you're adapting our products to your primary packaging needs or creating new systems, Akro-Mils welcomes Original Equipment Manufacturer (OEM) requests, such as Private Labeling/Rebranding, Display/Merchandising Systems and Kits/Packaging Solutions.

Call us at **800.253.2467** or visit **akro-mils.com**



Follow Us



©2012 Akro-Mils/Myers Industries, Inc. #AKM204



## OBITUARY

### **Donald Heppes 1940-2012**

Donald W. (Don) Heppes 72, died of cancer. He is the only person to head both the Industrial Fastener Institute and the National Fastener Distributors Association.

Heppes was 2001-02 NFDA President and the 1986-87 chairman of the IFI. He started his fastener career in 1974 with Times Screw in Rockford, IL. From 1976 to 1992 he worked for Milwaukee-

based Medalist Industries. In 1992 Heppes bought Pacific Fasteners, which he sold in 2006 to Bamal Corp. based in Sidney, Ohio.

Survivors include wife Gay Mead Heppes; daughters Lynn Hancock and Carol German; and five grandchildren.





## John Boe

*John Boe presents a wide variety of motivational and sales-oriented keynotes and seminar programs for sales meetings and conventions. John is a nationally recognized sales trainer and business motivational speaker with an impeccable track record in the meeting industry.*

*To have John speak at your next event, visit [www.johnboe.com](http://www.johnboe.com) or call 937-299-9001. Free Newsletter available on website.*

## SALES TRAINING TIPS FROM THE TRENCHES

If recruiting is considered the lifeblood of an organization, then training must certainly be its pulse. Experienced salespeople are often reluctant to take time away from their busy schedule for training and as a result, over time, become less productive. It is only natural to expect commission-based salespeople to resist any activity that takes them away from their customers. Award winning sales managers place a high premium on training and purposefully design their training programs to be timely, relevant, realistic, and reoccurring.

There is absolutely no substitute for a well-trained and highly motivated sales force! In his best selling book, *The 7 Habits of Highly Effective People*, Dr. Stephen Covey makes a strong case for the fundamental importance of training, or as he calls it, "sharpening the saw." In addition to skill development, Dr. Covey points out that time allocated for training also provides an opportunity for much needed personal reflection and renewal. Progress and growth are virtually impossible in an environment void of assessment and training.

Timing is everything. It is important to operate from a written training program and schedule training well in advance. Due to the damaging ripple affect on appointment calendars, training must be scheduled at least 30-days in advance and short notice changes should be avoided. Planning ahead not only helps minimize scheduling conflicts, but it also provides opportunity for training preparation and promotion. Attendees are typically more receptive and inclined to participate when they have been given sufficient time to plan and prepare for the training.

For training to be perceived as relevant and beneficial

by the sales force, they must be given the opportunity to contribute to topic selection. An excellent way to elicit input and establish training priorities is through the use of a self-administered, skills assessment survey. A well-designed survey will evaluate skill expertise over a wide array of categories such as administrative tasks, product knowledge, and sales proficiency. For example, it is quite common for a low producer to rate themselves high in

product knowledge and low in sales related categories. The skills assessment survey not only provides a good benchmark of an organization's current overall training level, but it also serves to identify potential peer trainers as well. With the appropriate person, peer training can be extremely effective and therefore should be encouraged.

As they say in the military, train like you plan to fight! Obviously, the more realistic and

thought provoking the training, the greater its impact. Build value into your training sessions by finding ways to inject realism. For example, if you are role-playing phone scripts, it's preferable to separate the participants and conduct the training over the phone vs. across the table. Due to the lack of visual cues, this approach closely mimics the real experience. If a picture is worth a thousand words, then videotaping a role-play session speaks volumes. Videotaped training sessions don't lie and therefore, provide an excellent opportunity for self-critique. A videotape provides meticulous feedback on body language and sales techniques that otherwise may go unnoticed.

Designing a successful training program is limited only by your creativity. With a little effort and imagination, you can develop a world-class training program that will excite your sales team and keep them coming back for more! 

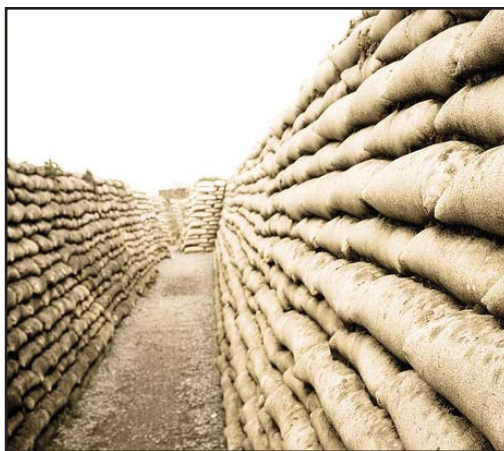

**DELTA**

Delta Engineering LLC



**Fills Boxes,  
Bags and  
Clamshells**

*Quality Delta Systems Since 1951*

**COUNTING, WEIGHING, &  
MATERIAL HANDLING SYSTEMS  
FOR PACKAGING OPERATIONS**

*If you currently use  
bench scales and  
package as little as  
four hours per day,  
the new Delta Short-Run  
Packaging System  
is made for you!*

**Fastener  
Packaging  
is our  
Specialty!**

3 Freedom Way  
Walpole, MA 02081 USA  
(781) 729-8650

[www.deltaengineeringcorp.com](http://www.deltaengineeringcorp.com)

## SHORT-RUN PACKAGING SYSTEM



Over 1,100 pages of fastener product standards — ASME, SAE, ASTM, and IFI.

More than 50% of the content in the 7th edition has been updated plus several new standards have been added.

For the first time this collection of standards is available either as a hard-bound book or as a digital file. See details at the IFI online store.

<b>Book Price</b> (USA & Canada):	<b>\$345</b>
<b>Book Price</b> (International):	<b>\$395</b>
<b>Digital Price:</b>	<b>\$345</b>

To place an order or find other **IFI** products,  
visit our website at: <http://www.indfast.org/shop/>



## Dave Kahle

Dave Kahle has trained tens of thousands of distributor and B2B sales people and sales managers to be more effective in the 21st Century economy. He's authored eight books, and presented in 47 states and seven countries. Sign up for his weekly Ezine, or visit his blog.

For more information, or to contact the author, contact: The DaCo Corporation, 835 West River Center Drive, PO Box 523, Comstock Park, MI 49321. Email: [cheryl@davekahle.com](mailto:cheryl@davekahle.com) <http://www.davekahle.com>, Phone: 800.331.1287 or 616.451.9377 Fax: 616.451.9412

## JUST LISTEN

I recently came across some research that confirmed what many of us in the profession of educating sales people have known for years: That purchasers would be "much more likely" to buy from a sales person if that sales person would just "listen" to the customer.<sup>1</sup>

Listening is one of the four fundamental competencies of a professional sales person, and yet, the profession is, in general, so poor at it that most customers remark on our inability to do it well.

Wow! If there is anyone I wouldn't want thinking I was a poor listener, my customers would be towards the top of the list.

Why is listening such a powerful sales competency? In my book *Question Your Way to Sales Success*, I describe a number of reasons. Here are a few.

First, it is our primary way of digging beneath the surface of a customer's needs and uncovering deeper and more powerful needs and motivations. That makes it a primary tool – of which the skillful use separates the master sales people from the mediocre. For example, it doesn't take any skill whatsoever to pick up an RFQ, a set of blueprints, or to write down a list of what the customer says he needs. You don't have to be a master listener to do that. But to dig deeper and uncover deeper issues, that takes the ability to listen.

Here's an example. In a routine sales call with a regular customer, the customer says, "We're thinking of going to X product. What's your price?"

Lots of sales people would look up the price and provide it. There. Job done.

The master would hear the words "Thinking of going..." and dig a little deeper. "What makes you

interested in that?" he says.

The customer replies: "Well, we're looking for a solution for a problem with our widget production line, and one of the key operators mentioned it as a possibility."

"I see. What sort of problem are you having in that production line?"

"An abnormally high reject rate."

"I may have some other solutions. Can I talk to your production manager?"

I don't have to take this scenario much further to make the point. A visit with the production supervisor could very well result in a deeper understanding of the problem and the development of an alternative solution with a whole lot more gross margin to it. The master sales person, exercising excellent listening skills, hears opportunities where many sales people don't. Listening is the

primary tool for digging deeper and uncovering deeper and more significant issues in our customers.

But that's not all. When we listen, we send a powerful message that we care about the other person. Conversely, when we don't listen, we send the message that our agenda is far more important than the customer's trivial ideas and issues. That makes effective listening one of the all time great relationship-building devices.

Listening requires us to take in information, ideas and opinions that are outside our comfort zone. It is, therefore, one of the primary tools we use to grow intellectually, to broaden our views, and ultimately, to become wiser and more knowledgeable. If we never listen to someone with a different perspective, we never consider the possibility that we might be wrong.

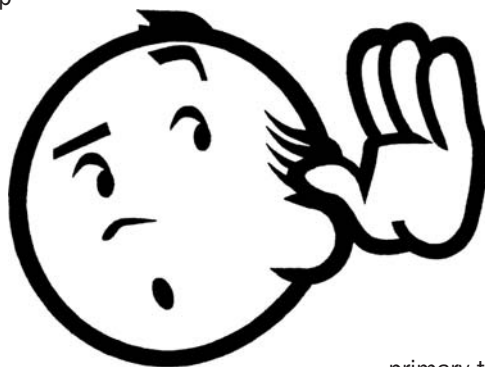

F468U  
F593G  
NC

ASTM F467/F468/MIL-S-1222H3/MIL-DTL-1222J/FF-S-86E  
MS17828/MS17830



**IDEAL SUPPLY, INC.**

New Corporate Office  
11400 Kreutzer Road • Huntley, IL 60142

Virginia Office  
624 Innovation Dr., Suite 101 • Chesapeake, VA 23320

**FASTENERS**

**MONEL 400, K500  
SILICON BRONZE  
651, 655**

**STAINLESS STEEL  
304 & 316**

**ILLINOIS**

Ph. 847.961.5900

Fx. 847.961.5300

Email: illidealsupply@aol.com

**VIRGINIA**

Ph. 757.548.8050

Fx. 757.548.8051

Email: vaidealsupply@aol.com

**ASTM B164/QQ-N-281/QQ-N-286**

**\*\*\*Domestic Monel/304SS/Naval Brass 464 Nuts\*\*\***

**For Hex Head Caps, Socket Cap Screws, Set Screws, Flat Sockets, Machine Screws, Finished Nuts, Heavy Nuts, Jam Nuts, Flat Washers, Lock Washers, Nylon Insert L/N, Studs and Threaded Rod all to Industry Specifications.**

MONEL® — Trademark of Inco Alloys

**JUST LISTEN** *continued from page 246*

From a sales person's perspective, the more we listen, the more different positions, motivations, opinions and nuances we are able to understand and accommodate. The wiser and more capable we become. Since we are able to understand an ever-growing panoply of positions and opinions, we are able to feel a rapport with more and more customers, and move closer to a consensus position with them.

Listening positions us as a consultant, not a peddler, in the eyes of the customer. Ultimately, listening provides us our competitive edge.

So how do we do it better? Here are two specific techniques to help you improve your listening effectiveness.

***Listen constructively.***

My wife is a crisis counselor. She talks about "listening empathetically." That means she listens in order to understand what a person is feeling. That is very appropriate for that type of work. However, we are sales people. It is more important that we listen "constructively." Think of "constructively – construction – building." We need to listen for things upon which to build. Listen for opportunities, problems, opinions, etc. on which we can build our solutions.

One way to do this is to plant a couple of questions into our mind before every sales call. These are questions for which we want to gain the answer. You could, for example, say to yourself before a sales call:

"What is the one thing that is this customer's most pressing challenge today?" And, you could ask yourself, "On what basis will this customer make the decision to buy or not?"

By planting those questions into your mind, you sharpen your sensitivity to what the customer says, enabling you to listen more constructively to the customer's conversation.

***Discipline yourself to build the habit of responding to your customer's comments.***

Here's how we think the sales interview should go.

- a. We ask a question.
- b. The customer answers.
- c. We ask another question.

When you exercise the habit of responding, you change the format. Now, it goes like this:

- a. We ask a question.
- b. The customer answers.
- c. We respond to the answer.
- d. We now ask another question.

Notice that we have intervened in the process with something we call a "response." A response is a verbal or non-verbal signal that we send to the customer that we are listening, and accepting what the customer says. It flatters the customer, makes him/her feel good about answering, and encourages him/her to answer in more depth and detail.



**Pinnacle Capital Corporation** has been serving the Investment Banking needs of the Global Fastener Industry since 1993. Contact us for expert guidance and assistance with:

- Business Sales / Divestitures
- Acquisitions & Acquisition Searches
- Strategic Investments & JV Partnerships
- Debt & Equity Financings
- Business Valuations & Fairness Opinions

All communications will be held in the strictest confidence.

**Pinnacle Capital Corporation**  
New York, New York  
212.267.8200

## DISTRIBUTOR NEWS

**General Inspection LLC** celebrates 20 years of leading the Inspection and Quality Control market

Gi is celebrating this great business accomplishment with a new logo and new website to lead them into the next several decades of doing business.

Continued investment has improved their edge in the market, releasing state of the art inspection machines and accompanying user-friendly software.

General Inspection LLC manufactures gauging, sorting, and inspection systems - all incorporating: Laser, eddy current, vision, and acoustic technologies for dimensional measurement, determining metallurgical defects as a method for achieving zero defects.

Contact Gi Toll Free: 1-888-817-6314 or 248-625-0529 in Michigan. Please visit Gi at [www.geninsp.com](http://www.geninsp.com).

\* \* \*

**Bryce Fastener Inc.** president and founder Bryce Campbell announced the launch of a website for its theft-proof fasteners:

Founded in 1972, Bryce designs and manufactures high security screws, nuts and bolts for government, banks, prisons, schools, electronics, solar, retail and other industries.

View the new website at [www.brycefastener.com](http://www.brycefastener.com).

## DISTRIBUTOR NEWS

At a board meeting held on July 12, 2012, the **New England Fastener Distributor's Association's** Board of Directors elected officers for the period 2012-2013. President Steve Wilson first introduced and welcomed the newly elected board members.

Newly elected Board Members are Dan Bielefield (Smith Associates), Barry Carpe (All-Tech Specialty Fasteners) and Jon Queenin (Specialty Bolt & Screw)

The Board of Directors then elected the new officers - **Chairman of the Board** - Barry Carp (All-Tech Specialty Fasteners) - **President** - Steve Wilson (Crescent Manufacturing) - **Vice President** - Lesley Carr (Northeast Fasteners Co. Inc.) - **Treasurer** - Rick Rudolph, (Lehigh-Armstrong).

For more information, contact the NEFDA at 1-860-529-4539 or visit their website at: [www.nefda.com](http://www.nefda.com).



# SRC

## Special Rivets Corp.



***Now has a company representative in the U.S.***

Headquartered in Taiwan with two factories in China and a monthly production capacity of 500 million blind rivets. SRC offers break stem blind rivets of various materials and some high strength STRUCTURAL blind rivets. Because of our high production capacity we offer good prices and service. SRC has been supplying blind rivets to some of the largest companies in the blind rivet market.

SRC now has a company representative in the U.S. to serve our customers. Tony Di Maio is well known in the blind rivet industry and he will assist you in every way he can. We appreciate the opportunity to quote your blind rivet needs. Contact Tony for catalogs.



SRC offers the following:

- Quality ISO Approved and Manufactures to IFI Specifications
- Competetive Pricing • Fast Delivery
- Fast, Accurate Communication • Technical Assistance by Tony



Contact: **Tony Di Maio**

6 Hermon Ave. • Haverhill, MA 01832

Phone & Fax: 978-521-0277 • Email: [tdimaio@verizon.net](mailto:tdimaio@verizon.net)

### JUST LISTEN *continued from page 247*

#### *Here are two powerful responses:*

A. Select one or two words out of the customer's conversation, and repeat them back to the customer, nodding your head.

Here's an example. You ask the question, "Which of these challenges are most pressing for you?"

The customer responds by talking for a few moments about his challenges. When he pauses, you say, "back orders" and nod your head. "Back orders" was one of the issues he talked about. You just repeated it, and nodded your head.

That's a powerful response because it shows the customer that you have listened to the point that you have captured and repeated one of his main thoughts. That feels good to the customer and conditions him to answer the next question with even more depth and detail. Just as importantly, since you were focused on finding a key word or two to repeat, you had to listen to the customer's conversation! This technique forced you to listen more effectively, and made the customer feel good in the process.

B. Summarize and rephrase what the customer has said, and repeat it back to him.

This is similar to the one or two word techniques discussed above, more intense. When the customer has finished answering your question, you say something like this: "Let me see if I understand you correctly. In other words, what you are saying is....." Paraphrase and give him back your understanding of what he just said.

Like the prior technique, this is a powerful tool because it forces you to listen, it engages the customer, and it seeks agreement. Using this a couple of times in the sales interview will make the customer feel good about you, ensure that you understand him, and create an atmosphere of agreement.

Ultimately, your ability to listen more effectively evolves out of your discipline to apply some of these techniques regularly and methodically. If you are going to listen more effectively, you must first make the commitment to expend the effort to do so. 

Sales & Marketing Management Magazine, August, 2005<sup>1</sup> The survey found that some of the worst offenders were experienced sales people.



Industrial Fasteners Institute  
636 Oak Tree Blvd. • Independence Ohio 44131  
Phone: 216.241.1482 • Fax: 216.241.5901  
www.indfast.org



## IFI TECH UPDATE 2Q 2012

by Joe Greenslade Director of Engineering Technology, IFI

Industrial standards are the foundation of the fastener industry. Even though most standards are quite mature work is constantly going on with in the various standards organizations to keep standards relevant and up to date. Below is a summary of the standards activities that took place during the second quarter of 2012.

### Standards Organizations Activities

#### a. Standards published during the second quarter 2012:

- i. **ASTM A193/A193M**, Alloy Steel and Stainless Steel Bolting Materials for High Temperature Service
- ii. **ASTM F901** – 12, Aluminum Tower Bolts and Nuts
- iii. **SAE J81** – Inch Thread Rolling Screws – This standard has been “Stabilized”. This means it will no longer be updated or maintained. The Rationale states that inch thread rolling screws are now covered by ASME B18.6.3 and that standard should be used for future reference.
- iv. **ISO 4162**, Hexagon bolts with flange — Small series Product grade A with driving feature of product grade B
- vi. **ISO 7041** (2012), Prevailing torque type hex nuts (with non-metallic insert) style 2 – property classes 9 and 12
- vii. **ISO 10642**, Hexagon socket countersunk head screws, Amendment

#### b. ASME B18 Standards in the revision process:

- i. **B18.2.1**, Inch Bolts and Cap Screws - The comments from the first ballot have been addressed and the second ballot will be issued during second week of August.
- ii. **B18.2.5M**, Metric Twelve Point Screw – The comments from the first ballot have been addressed and the second ballot was issued during last week of July.
- iii. **B18.6.3**, Inch Machine and Tapping Screws – The comments from the first ballot have been addressed and the second ballot will be issued before the end of August.

#### c. ASTM F16 in the revision process:

- i. **ASTM F959/F959M**, Direct Tension Indicating Washers (DTI)- A ballot closed on the revision of section 5.3 and was approved by the sub-committee in May and it will go

out for a main committee ballot during early August.

- ii. **ASTM A193/A320** – a joint working group of ASTM members of F16 and A01 has been created to more thoroughly defined method of applying tolerances to continuously threaded studs. Once completed both ASME B18.31.2 and ASTM A962 (covering A193 and A320) will be modified to adopt the refined method of tolerancing and inspecting stud lengths. Two web conferences were held during July and good progress was made. It is expected that no later than Mid-September a ballot will be proposed to incorporate the length calculating formula and a table covering the most common sizes will be submitted to A 01 for inclusion in ASTM A962. A similar proposal will follow for ASME B 18 to adopt the same formula into B18.31.2

#### d. SAE in the revision process:

- i. **SAE J429** – A revision will be balloted before the end of August. This will put J429 closer in alignment with the chemistry requirements in ISO 898-1, but a slightly higher carbon content will be maintained for Grade 8 products than the comparable ISO 898-1, property class 10.9.

#### e. ISO in the revision process:

- i. ISO 10683, zinc flake coatings for fasteners
- ii. ISO 4042, electroplating finishes for fasteners
- iii. ISO 3269, fastener acceptance
- iv. ISO 6157, fastener surface discontinuities
- v. ISO 2320, locking nut performance

#### f. IFI in revision process:

- i. **IFI 114**, Break Mandrel Blind Rivets – work will begin on a new revision by the end of August.
- ii. **IFI 134**, Multi-grip Flush Break Pull Mandrel Self-Plugging Blind Rivets - a ballot on the revision will go to the membership before the end of August.

For readers interested in more information send questions to [techinfo@indfast.org](mailto:techinfo@indfast.org). 





# FASTENER PUZZLE SOLUTIONS

## Fastener Crossword Solution

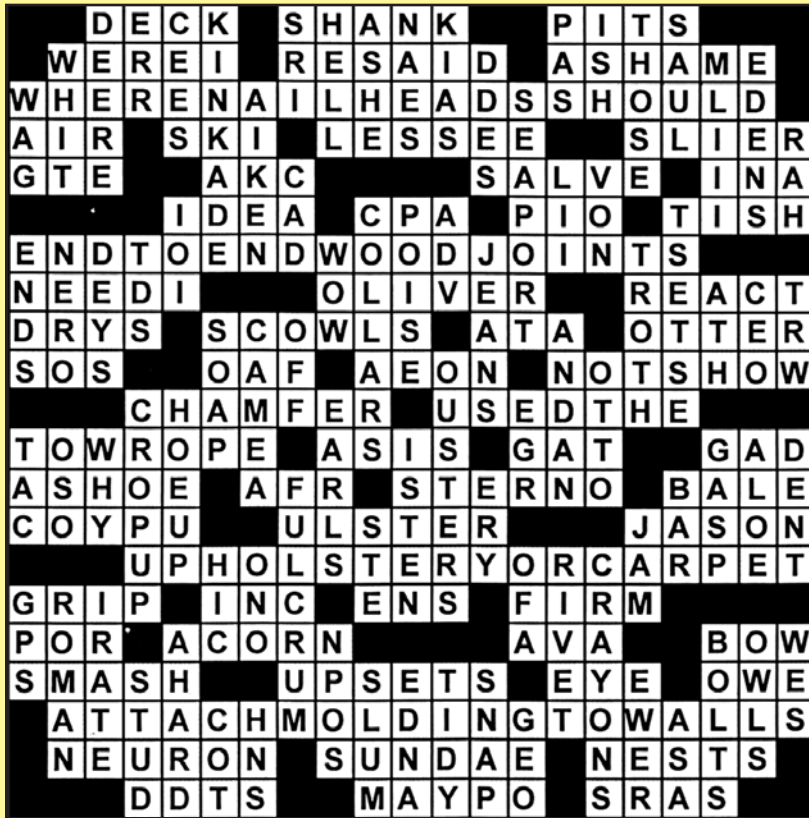

## Fastener Wordsearch Solution

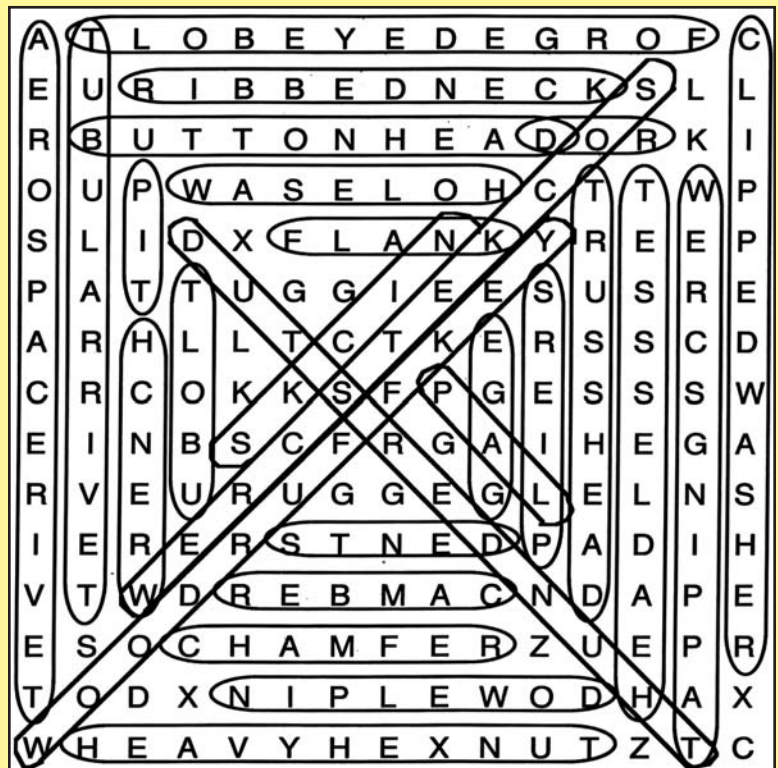

# ADVERTISERS INDEX

## A

- ABBOTT INTERFAST 60**  
Your complete fastener house  
Tel (847) 777-3030  
Fax (847) 459-4076
- ABLE LABEL SYSTEMS, LLC 157**  
Product ID labels & hardware/software  
Tel (877) 414-5867  
Fax (509) 272-3845
- ACCURATE MFG. PRODUCTS GRP 77, 79**  
Full line of extra thick component washers.  
#0 thru 4" bolt sizes, std & special sex bolts  
Tel (317) 472-9000  
Fax (317) 472-9010
- ACF COMPONENTS 50**  
Master stocking distributor of AVK, Bivar, Heyco, Panduit, Richco, RAF, 3M  
Tel (800) 227-2901  
Fax (510) 471-7018
- ACS MANUFACTURING, INC 45**  
Formed spring steel fasteners  
Tel (888) NUTS-R-US  
Fax (847) 695-6336
- ADVANCE COMPONENTS 7**  
The Distributor's source for specialty fasteners  
Tel (972) 446-5500  
Tel (972) 446-5500
- ADVANCED POLY-PACKAGING, INC. 227**  
Do you bag fasteners? We provide solutions for low and high volumes.  
Tel (800) 754-4403  
Fax (330) 785-4010
- AJAX WIRE SPECIALTY CO., INC. 163**  
Wire spring manufacturer. Short & long runs, all sizes, all lengths.  
Tel (800) 966-AJAX  
Fax (516) 935-2334
- AKRO-MILS 243**  
Leading manufacturer of plastic and metal storage, organization, transport and material handling products designed for any setting.  
Tel (330) 761-6323  
Fax (330) 761-6347
- ALBANY STEEL & BRASS 75**  
Specialty Tapping Screws - Swageform  
Tel (312) 733-1900  
Fax (312) 733-9887
- ALCOA FASTENING SYSTEMS 189**  
Makers of Huck®, Marson and Recoil® brand fasteners. AFS offers the greatest depth of fastening solutions in the industry.  
Tel (800) 388-4285  
Fax (800) 798-4825
- ALFA TOOLS (A DIVISION OF ALFA MANUFACTURING) 73**  
Full line of drills, taps, dies, annular cutters, end mills, abrasives and screwdriver bits.  
Tel (800) 253-2532  
Fax (800) 258-6657
- ALL AMERICAN FASTENER SHOW 135**  
Tel (877) 865-8237
- ALL AMERICAN WASHER WERKS 104**  
Quality producers of washers and stampings  
Tel (847) 566-9091  
Fax (847) 566-8381
- ALLEGHENY BOLT & SCREW 229**  
Distributor of screws & nuts  
Tel (800) 543-2614  
Fax (800) 543-2615
- ALLOY & STAINLESS FASTENERS 33, 159**  
Specialty steel fasteners  
Western Tel (503) 885-2464  
Western Fax (503) 885-2385  
Central Tel (713) 466-3031  
Central Fax (713) 466-9591  
Eastern Tel (215) 721-3900  
Eastern Fax (215) 721-9578
- ALPHA-GRAINGER MFG. CO. 25**  
Electronic hardware, captive screws, shoulder screws, spacers & standoffs  
Tel (508) 520-4005  
Fax (508) 520-4185
- ALUMINUM FASTENER SUPPLY CO., INC 152, 153**  
Specializing in a wide range of aluminum fasteners  
Tel (800) 526-0341  
Fax (239) 643-5795
- AMERICAN IMPERIAL SCREW CORP. 97**  
500 million fasteners in various materials and finishes. Stocking distributor of spring steel fasteners.  
Tel (800) 431-2391  
Fax (845) 354-4377
- ANDROCK HARDWARE 127**  
304 Stainless steel eyebolts, S-hooks in 304SS & eye bolts with lag threads  
Tel (815) 229-1144  
Fax (815) 229-1895
- APPLIED BOLTING TECHNOLOGY 259**  
Manufacturer of Direct Tension Indicators. A simple, accurate & cost effective product used to measure tension on A325 & A490 bolts.  
Tel (800) 552-1999  
Fax (802) 460-3104
- ARK-PLAS PRODUCTS 128**  
Polyethylene and Nylon Post and Screws  
Tel (870) 453-2343  
Fax (870) 568-0811
- ATLANTA ROD & MFG. CO., INC. 109**  
Domestic women-owned manufacturer of headed and anchor bolts, specialty and domestic nuts and construction fasteners.  
Tel (800) 633-6794  
Fax (706) 356-1842
- AUSTIN HARDWARE & SUPPLY 193**  
Authorized stocking distributor, tool repair facility for the finest brand name fasteners and installation tools including vendor managed inventory programs.  
Tel (800) 220-8118  
Fax (888) TO-RIVET
- AZ LIFTING HARDWARE 123**  
Carbon and stainless steel eyebolts, eye nuts, shackles, wire rope clips, lifting eye bolts, turnbuckles, thimbles, hooks & swivels.  
Tel (888) 936-1466  
Fax (623) 936-8909
- AZTECH LOCKNUT CO. 173**  
Metal prevailing torque locknuts of all types in a majority of sizes.  
Tel (800) 321-5625  
Fax (630) 236-3210

## B

- BARSTOCK SPECIALTIES, INC. 131**  
Specialty Steel and Metal Processing for Your Custom Bar Requirements  
Tel (713) 849-0055  
Fax (713) 466-3583
- BAY FASTENING SYSTEMS 3**  
A leader in the engineered fastener industry since 1962. Millions in stock, lowest prices, next day delivery.  
Tel (800) 718-8818  
Fax (516) 294-3448
- BBC FASTENERS 100**  
Manufactures hot forged and cold headed standard and specialty fasteners. They offer expedited service for your cold headed prototypes.  
Tel (708) 597-9100  
Fax (708) 597-0423
- BEACON FASTENERS 47**  
Lowest Prices - Largest Inventory on Stock  
Thread Forming, Thread Cutting, Sheet Metal/Tapping, High-Low Tapping and Sems Screws.  
Tel (800) 669-2658  
Fax (847) 541-1789
- BETA STEEL 121**  
Steel Wire and Rod; Processing, - Warehouse Distribution, JIT Inventory  
Tel (586) 323-6800  
Fax (586) 323-6806

THE  
DISTRIBUTOR'S

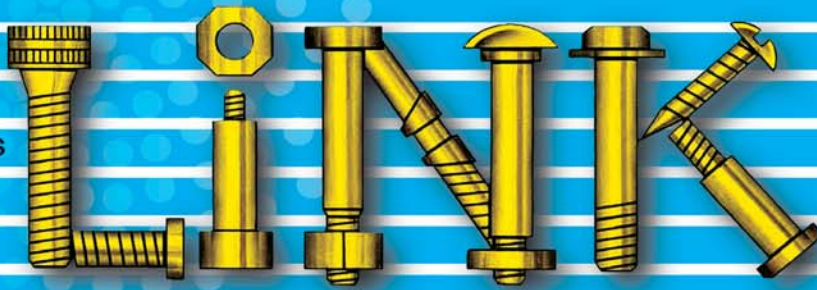

**NEW**  
DIGITAL MAGAZINE  
[www.linkmagazine.com](http://www.linkmagazine.com)

THE NATIONAL MAGAZINE FOR FASTENER DISTRIBUTORS

reserve your  
spot for the  
winter 2013  
issue now.



*All Advertisers Get:*  
free feature article free web directory ad  
free online edition ad free online hyperlinking

*Issue Deadlines:*  
editorial November 23, 2012  
ad material December 1, 2012

*Distributed At:*  
SEFA Spring Conference and Tabletop Show, Stone Mountain, GA  
Pac-West Spring Conference and Tabletop Show, Long Beach, CA

Contact us for Advertising Opportunities tel 1.800.356.1639 • 239.643.2713  
email [maryann@linkmagazine.com](mailto:maryann@linkmagazine.com) • [tracey@linkmagazine.com](mailto:tracey@linkmagazine.com)

# ADVERTISERS INDEX

## B continued...

### BIG RED FASTENERS 67

Domestic manufacturer of B7 studs providing fast and accurate service. Expedited service is available.  
Tel (918) 251-7291  
Fax (918) 251-7311

### BRIGHTON-BEST INTERNATIONAL OBC

Socket screw products - L-Nine products - Grade 8 hex head - pipe plugs - shoulder bolts - hex keys - square head set screws - dowel springs-nuts-metrics  
Tel (562) 808-8000  
Fax (562) 808-8108

### BRITISH METRICS 241

Metric and British Hardware  
Tel (410) 857-3990  
Fax (410) 857-3766

### BUCKLEY QC 193

Self locking fasteners  
Tel (800) 344-3874  
Fax (716) 662-0669

## C

### CABLE TIE EXPRESS 93

Master distributor for cable ties and wire management products  
Tel (888) 603-1233  
Fax (800) 395-1233

### CAPTIAL MARKETING 64

Business development and improvement, fastener applications, merger and acquisition, supply chain management, and strategic planning.  
Tel (336) 884-1704  
Fax (336) 884-1778

### CARDINAL FASTENER, INC. 119

Largest manufacturer of hot forged fasteners in North America. Product ranges from 1/2" to 3" diameter or M20-M72.  
Tel (216) 831-3800  
Fax (216) 292-1465

### CAVALIER INDUSTRIAL SPECIALTIES 167

Provides manufacturing and quality processes for non-standard made-to-order steel fasteners  
Tel (757) 427-6405  
Fax (757) 427-2315

### CHICAGO HARDWARE & FIXTURE CO. 65

Manufacturer of steel forgings and wire forms for the Fastener, Industrial & Marine industries  
Tel (847) 455-6609  
Fax (847) 455-0012

### CHRISLYNN THREADED INSERTS 68

Professional thread repair, precision helical wire, rock solid K-Type, E-Z Fix, E-Z Lok, no minimums, same day shipping.  
Tel (800) 926-1495  
Fax (888) 526-4566

### COMPONENT PACKAGING 127

Contract packager specializing in the fastener industry - automated or hand bagging, shrink packaging and assembly.  
Tel (417) 624-9395  
Fax (417) 624-2303

### COMPUTER INSIGHTS 19

Offering "The Business Edge," a complete integrated system for fastener distributors  
Tel (800) 539-1233  
Fax (630) 893-4030

### COPPER STATE BOLT & NUT 125

Manufacturers of pre-headed & square bolts.  
Tel (800) 528-4255  
Fax (602) 272-3316

### COUPLINGS COMPANY 219

Brass fittings for industrial, plumbing, truck and automotive.  
Tel (847) 634-8990  
Fax (847) 634-9282

### CRAFTLINE STORAGE SYSTEMS 177

Bin cabinets, drawer systems, compartment boxes, fastener storage systems, custom products, tip-out cabinets, racks-since 1945  
Tel (800) 505-9099  
Fax (203) 234-7978

### CRESCENT MANUFACTURING 235

Specialize in miniature fasteners  
Tel (860) 673-2591  
Fax (860) 673-5973

### CTG INTERNATIONAL, LLC 107

Standard and non-standard fasteners  
Tel (909) 598-9251  
Fax (909) 598-6042

### CURTIS METALFINISHING CO. 164

Experts in the application of Engineered Coatings. Coating systems include: Magni, NOF-MCNA, PPG, Whitford and Yuken.  
Tel (586) 939-2850  
Fax (586) 939-6140

## D

### THE DALE COMPANY 63

U-Bolts, Square U-Bolts, Anchor Bolts, Studs, J-Bolts, Eye Bolts and S-Hooks  
Tel (713) 928-3437  
Fax (713) 928-8065

### DARLING BOLT 113

Large and special hex cap screws & socket products in addition to 12 point flange screws  
Tel (800) 882-0747  
Fax (586) 757-1555

### DDI SYSTEM 150

Distribution software that seamlessly combines daily operations with advanced sales and marketing tools.  
Tel (877) 599-4334

### DELTA ENGINEERING 245

Manufacturer of fastener packaging systems to count or weigh-count a wide variety of fasteners into boxes, bags, clamshells and jars.  
Tel (781) 729-8650

### DELTA SECONDARY 103

Cut off & chamfer, cut threading, cross drilling, drilling & tapping, turning, milling, slotting, grooving. Quality machine shop offering fastener distributors over 35 years of machining experience.  
Tel (630) 766-1180  
Fax (630) 766-1285

### DETROIT WASHERS & SPECIALS 56

Domestic manufacturer of washers, shims and other special stampings. ISO TS-26949 certified.  
Tel (734) 338-8339  
Fax (734) 261-9210

### DISTRIBUTION ONE 52

Distribution software for your fastener wholesale distribution business  
Tel (888) 730-8600  
Fax (609) 387-7600

### DISTRIBUTOR'S LINK, INC. 225, 253

Tel (800) 356-1639  
Fax (239) 643-5220

### DIVSPEC 72

Full line fastener distributor including strut and strut accessories.  
Tel (908) 688-2550  
Fax (908) 688-9385

### DRILLCO CUTTING TOOLS 87

Ruggedly constructed heavy duty drills. NITRO is designed to drill harder alloy steels, including the aluminum alloys, harder stainless steels and titanium alloys.  
Tel (800) 851-3821  
Fax (800) 315-9225

### DUPAGE PRODUCTS GROUP 141

Quality Kits, Globally Sourced, Globally Priced!  
Tel (800) 323-7208  
Fax (630) 969-0310

### DURHAM MFG. 69

Producers and distributors specializing in industrial storage, metal and plastic products used in packaging, storing, and organizing maintenance products.  
Tel (800) 243-3774  
Fax: (800) 782-5499

# THE SPECIALISTS IN STUDS & THREADED RODS



## ● **THREADED RODS**

0-80 TO 3 1/2" Diameter  
Lengths to 20 Feet  
Right or Left Hand Thread

## ● **SPADE BOLTS**

6-32 to 3/4-10 Diameter  
With or Without Holes

## ● **CUSTOM BENT BOLTS**

U-Bolts - Rnd & Sqr Bend  
J, L, V & Eye Bolts  
Anchor & Hook Bolts

## ● **MATERIALS**

Carbon Steel (All Types)  
Alloy Steel: 4037A, 4140, 8620  
B-7, B-16, Stainless Steel  
Copper, Brass, Bronze, Nickel  
Alloys, Monel, Aluminum

## ● **STUDS**

0-80 to 3 1/2" Diameter  
Continuous Thread  
Single End Thread  
Double End Thread  
Roll or Cut Thread  
Right or Left Hand Thread  
UNC-Course Thread  
UNF-Fine Thread  
UNEF-Extra Fine Thread  
Special Pitch Threads  
Acme Threads  
Metric Threads  
End Slotted  
Turned Down Diameter

## ● **SCREW MACHINING**

## ● **CNC PRECISION MACHINING**

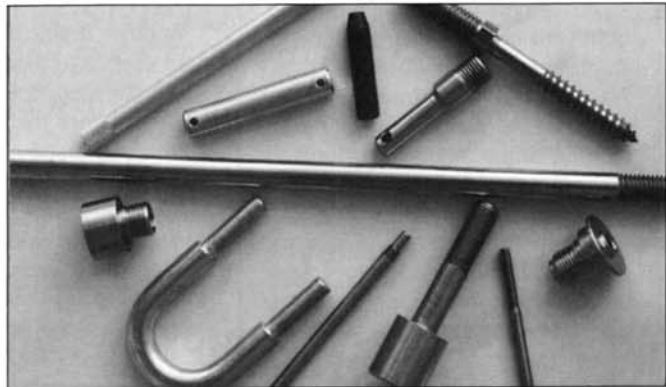

**TUTTLE**  
**MFG. CO.**



A Division of Arlington Fastener Company  
1032 W. Northwest Hwy, P.O. Box 590 Barrington, IL 60010  
(847) 381-7713 ph • (847) 381-9450 fx

Visit us at [thomasregister.com](http://thomasregister.com) to view our catalog

# ADVERTISERS INDEX

## D continued...

**THE DYSON CORPORATION 107**  
Domestic bolt and nut assemblies in stock for quick delivery.  
Tel (800) 680-3600

## E

**E & A PRODUCTS 84**  
Anchor bolts, threaded rod, special hex nuts, coupling nuts and domestic fasteners.  
Tel (800) 711-0830  
Fax (763) 493-3214

**EASTWOOD MANUFACTURING 58**  
Manufacturing in all materials; specials and non-standards  
Tel (281) 447-0081  
Fax (281) 447-0098

**ELGIN FASTENER GROUP 108**  
Industrial fasteners from Ohio Rod Products, Versailles, IN; Leland-Powell, Martin, TN; Chandler Products, Precision Screw & Bolt, Cleveland, OH  
Tel (812) 689-8917

**ELITE SALES, INC. IFC**  
Importers of wire rope, strand, cable, hardware, chain products in ungalvanized, galvanized, and stainless steel.  
Tel (305) 262-3105  
Fax (305) 262-3859

**EMPIRE FASTENERS 163**  
Fillister head - specialty drilling  
Tel (800) 598-5212  
Fax (718) 726-4067

**EUROLINK FSS 139**  
Premier US distributor of metric fasteners and specializes in complimenting and extending your basic fastener lines with hard-to-find metric fasteners manufactured to both DIN and ISO standards. The nation's leading source for hard-to-find metric fasteners.  
Tel (866) 787-7594  
Fax (864) 801-3606

**E-Z LOK 126, 224**  
Providing a range of thread inserts for metal, wood & plastic  
Tel (800) 234-5613  
Fax (310) 353-4444

**EZ SOCKETS, INC. 39**  
Providing a range of socket products in alloy or stainless  
Tel (800) 631-7833  
Fax (973) 376-7130

## F

**FALL RIVER MFG CO., INC. 37**  
Stainless steel & non-ferrous fasteners  
Tel (800) 275-6991  
Fax (508) 675-8770

**FASCOMP 46, 157**  
Spacers, standoffs, handles, captive screws, shoulder screws, thumbscrews, jackscrews, handles and ferrules.  
Tel (407) 226-2112  
Fax (407) 226-3370

**FASTAR, INC. 34**  
Coiled spring pins, slotted spring pins, dowel pins, cotter pins, taper pins, and special pins  
Tel (888) 327-8275  
Fax (845) 369-7989

**FASTENER WEBSITES 184, 186, 188, 190, 192, 194, 196, 198**

**FASTENER REFERENCE CHART 200**

**FORD FASTENERS, INC. 15**  
Self-drilling, tapping-thread cutting screws - 410 stainless  
Tel (800) 272-3673  
Fax (201) 487-1919

## G

**GF&D SYSTEMS 217**  
Grease fittings for every industry.  
Tel (800) 360-1318  
Fax (262) 789-8640

**GLOBALFASTENERNEWS.COM 257**  
24-hour online news service dedicated to the fastener industry.

**GREAT LAKES PARTS 86**  
Wheel nuts for heavy duty trucks, light duty trucks and passenger cars.  
Tel (440) 546-0304  
Fax (440) 546-0306

**GREENSLADE & COMPANY, INC 151**  
Provide fastener inspection equipment, dimensional calibration and innovative gage design to manufacturers and distributors.  
Tel (817) 870-8888  
Fax (817) 870-9199

## H

**HANGER BOLT & STUD CO 57**  
Hanger bolts, studs, dowel screws, pins  
Tel (800) 537-7925  
Fax (800) 994-2658

**HANSON RIVET & SUPPLY CO. 59**  
Rivets, threaded inserts, riveting tools, riveting machines, washers  
Tel (866) 61-RIVET (617-4838)  
Fax (323) 221-5300

**HILLSDALE TERMINAL 40**  
Solderless terminals (vinyl, nylon & heat shrink). Instant tap connectors, wiring accessories  
Tel (800) 447-3150  
Fax (517) 849-9516

**HOLBROOK MFG, INC. 2**  
World-class manufacturer of Custom and Standard Fasteners geared toward engineering products for the future.  
Tel (847) 229-1999  
Fax (847) 229-0996

**ICS FLANGE 85**  
Stocks flange bolts and nuts in Grade 5, 8, 8.8 and 10.9 in steel and stainless. These parts are available in any finish.  
Tel (800) 231-0360  
Fax (800) 586-2461

**IDEAL FASTENERS 41**  
Specialists in Precision socket head cap screws  
Tel (714) 630-7840  
Fax (714) 632-3829

**IDEAL SUPPLY, INC. 247**  
One of the largest Monel fastener inventories in the world to meet your customer's commercial/military requirements to ASTM/MIL-SPEC.  
Tel (815) 477-4427  
Fax (815) 477-7252

**IMPERIAL RIVETS & FASTENERS CO., INC. 133**  
Manufacturer of special fasteners; rivets, binding post screws, anchors  
Tel (630) 964-0208  
Fax (630) 963-0289

**INDUSTRIAL FASTENER INSTITUTE 245**  
Technical Fastener Association  
Tel (216) 241-1482

**INDUSTRIAL NUT CORP. 207**  
Special nuts, locknuts, and machined steel parts  
Tel (419) 625-8543  
Fax (419) 625-5517

# News Plus More.

News Briefs

Feature Articles

FIN Fastener Stock Tracker

Daily Fastener Quiz

FIN Classifieds

Product News

Fastener History

FIN Calendar

Trade Shows

Associations

Article Store

Fastener Quality

Obituaries



# GLOBAL

## FASTENER NEWS.COM

Tel 503-335-0183 E-mail [FIN@GlobalFastenerNews.com](mailto:FIN@GlobalFastenerNews.com)

2207 NE Broadway #300, Portland, OR 97232, USA

# ADVERTISERS INDEX

*Continued...*

## INDUSTRIAL RIVET & FASTENER CO.

**FOLDOUT**

One name, one number, one source for all your rivet needs

Tel (800) 289-7483

Fax (201) 750-1050

## INTERFAST GROUP

**219**

Distributor/importer of drywall, deck, self-drilling and self-piercing screws.

Tel (800) 605-1233

Fax (909) 930-2183

## INTERCONTINENTAL SALES

### CORPORATION (I-S-C)

**209**

Niche Wholesaler of Fastener and Building Products. No minimum order, same day shipping, private labeling at no extra charge.

Tel (800) 741-4278

Fax (800) 892-0983

## INxSQL

**101**

Provide distribution ERP solutions for the Fastener Industry.

Tel (877) 446-9775

## JAY-CEE SALES & RIVET

**35**

Quality rivets in steel, copper, brass, stainless, monel, aluminum

Tel (800) 521-6777

Fax (248) 478-6416

## JTD STAMPING CO. INC.

**143**

Manufacturer of all types of washers

Tel (800) 927-7907

Fax (631) 643-40166

## K

## KEN FORGING, INC.

**23, 51**

Manufacturer of forged eye bolts, rod ends, stainless, clamps

Tel (888) 536-3674

Fax (440) 992-0360

## KEY BELLEVILLES

**59**

Belleville disc springs - made in the U.S.A.

Tel (800) 245-3600

Fax (800) 847-1672

## KINTER

**137, 203**

Specializing in X-mas tree and ratchet style push-in fasteners made of nylon; binder posts, screws and sex bolts made of aluminum and steel; Zip-It wall board anchors and economy style screw drivers and wrenches.

Tel (800) 323-2389

Fax (847) 623-0105

## KNAPP FASTENERS, INC.

**105**

Source for all of your fastener requirements since 1987. Serving the Aerospace, Military, and Industrial Markets for over 25 years.

Tel (519) 653-4558

Fax (519) 653-4558

## K-T BOLT MFG. CO. INC.

**147**

Bolt manufacturing, forging

Tel (800) 553-4521

Fax (281) 391-2673

## LELAND INDUSTRIES INC

**117**

Domestic manufacturer of bolts, nuts, screws in carbon or stainless. Custom threading and specials. Wire bending, threading to 4". Bolts to 6" x 3/4" dia, U-Bolts and Anchors.

Tel (800) 263-3393

Fax (416) 291-0305

## LOCKNUT TECHNOLOGY

**83**

Manufacturer of All-Metal Prevailing Torque Locknuts and Flextop™ Locknuts.

Tel (630) 628-5330

Fax (630) 628-5331

## LOK-MOR, INC.

**29**

Full line of locknuts

Tel (800) 843-7230

Fax (817) 453-2923

## LYN-TRON, INC.

**199**

Precision electronic hardware, custom standoffs, precision shoulder screws, captive panel screws, handles, spacers, connector hardware, NAS spacers and standoffs, swage standoffs.

Tel (509) 456-4545

Fax (509) 456-0946

## M

## MAR-BRO MANUFACTURING, INC.

**169**

Standard and special cold form fasteners

Tel (602) 278-8197

Fax (602) 269-1235

## MEHTA TRADING INTERNATIONAL

**74**

The complete stainless steel fastener source for MILL shipments.

Tel (888) 324-6974

Fax (972) 642-1244

## METRIC FASTENERS CORP

**9**

Metric Fasteners at competitive prices. Wide variety of materials including Stainless Steel A2 & A4. High quality standards, full lot and batch traceability and E-business solutions.

Tel (877) 425-7611

Fax (614) 777-7614

## METRIC & MULTISTANDARD COMPONENT CORP.

**13**

Fasteners, specialties, tubings/fittings, wrenches, cutting and measuring tools

Tel (800) 431-2792

Fax (914) 769-5049

## MICRO PLASTICS CORP.

**1**

Nylon fasteners, printed circuit board fasteners & assortment kits

Tel (870) 453-8861

Fax (870) 453-8676

## MW INDUSTRIES, INC - TEXAS

**27**

Texas based, ISO 9001:2008 certified, manufacturer of washers, special fasteners and metal stamping for 35 years.

Tel (800) 875-3510

Fax (281) 233-0449

## N

## NATIONAL THREADED FASTENERS

**165**

Grade 8 hex flange screws, grade 5 serrated flange screws, extra thick SAE thru-hard flat washers, grade G hex flange locknuts, complete line of standard fasteners in packaged and bulk quantities. New expanded line includes specialty flat washers in both package and quarter keg quantities.

Tel (440) 350-1430

Fax (440) 350-1676

## NATIONWIDE PACKAGING SERVICES

**131**

Commercial and mil-spec fastener packaging.

Tel (973) 882-1711

Fax (973) 882-1742

## ND INDUSTRIES

**21, 129**

Self-locking and self-sealing processes

Tel (800) 521-2663

Fax (248) 288-0022

## NORTHEAST FASTENERS

**11**

Supplying a range of fasteners for the Commercial, military, aerospace and automotive industries.

Tel (860) 589-3242

Fax (860) 589-6969

## NOVA FASTENER, CO.

**223**

Full line screws, nuts, bolts, washers, and fence related parts.

Tel (800) 645-1234

Fax (631) 225-6828

## NUCOR FASTENER CORP.

**80, 81**

Manufacturer of a range of nuts, bolts & washers

Tel (800) 955-6826

Fax (260) 337-1726



# Standard DTIs\*    Squirter® DTIs\*



## In-Stock and Ready to Ship

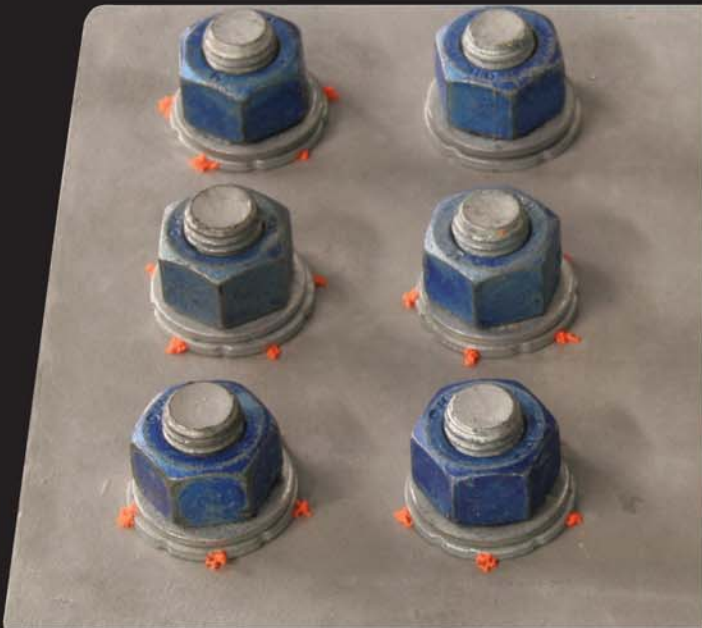

- \*USA's only Quenched and Tempered DTIs in accordance with ASTM, RCSC and the Fastener Quality Act.
- Squirter® DTIs are covered by ASTM, ASME and AASHTO.
- DTI CERT's/MTRS online



Watch our field bolting clinics.  
Scan with Smart phone or  
view on line at [appliedbolting.com](http://appliedbolting.com)



the best way to bolt!

[www.appliedbolting.com](http://www.appliedbolting.com)

email: [info@appliedbolting.com](mailto:info@appliedbolting.com)

1 800 552 1999    1 802 460 3100

TRAINING • FIELD SUPPORT • TECHNICAL EXPERTISE

# ADVERTISERS INDEX

**O**

**OFFSHORE MILLING SERVICES, INC. 64**  
Your One-Stop for Factory-Direct Fasteners  
Tel (503) 244-1516  
Fax (503) 452-9855

**OSSCO BOLT & SCREW CO., INC. 183**  
Distributor of nuts - full range  
Tel (800) 367-2688  
Fax (401) 461-6970

**P**

**PAC FAS div. BIG H CORP. 195**  
Full line supplier of packaged fasteners  
Tel (800) 444-5834  
Fax (800) 388-8077

**PACIFIC WAREHOUSE SALES 263**  
Fastener distribution warehouse for spring pins, taper pins, dowel pins, woodruff keys, studs, threaded rods, blind rivets, key stock & cable ties.  
Tel (909) 287-7750  
Fax (909) 287-7755

**PETERSON SPRING 149**  
Largest privately owned spring manufacturer in the US. Core competencies are designing, manufacturing, prototyping, and supply the highest quality products: springs, constant-tension hose clamps, snap rings, stampings and wire forms.  
Tel (248) 355-5489 for ring inquiries  
Tel (248) 355-5838 for all other inquiries  
Fax (248) 357-5874

**PIVOT POINT, INC. 95**  
Award-winning non-threaded fastener solutions. Quick release pins, clevis pins, and cotter pins.  
Tel (920) 349-3251  
Fax (920) 349-3253

**PINNACLE CAPITAL CORPORATION 248**  
Business Sales/Divestitures; Acquisitions and Acquisition Searches. Serving the Global Fastener Industry since 1993.  
Tel (212) 267-8200

**POWERS FASTENERS 175**  
Private company specializing in global marketing of quality packaging and fastening products for concrete, masonry and steel.  
Tel (914) 235-6300  
Fax (914) 235-5881

**PRECISION SPECIALTIES 235**  
Precision Specialties has been supplying OEMs and distributors with "Simply the Best" service and availability of specialty fasteners for over 25 years.  
Tel (901) 854-5640  
Fax (901) 854-5702

**PRECISION TECHNOLOGY SUPPLIES 43**  
Complete range of Stainless Steel Metric Fasteners. Door-to-door from the UK in 2 days.  
Tel +44 (0)1342 410758  
Fax +44 (0)1342 311464

**PRESTIGE STAMPING 115**  
Mfg. washers & small stampings  
Tel (586) 773-2700  
Fax (586) 773-2298

**Q**

**QUANTUM STORAGE SYSTEMS 187**  
A leading provider of plastic bins and wire shelving systems. Quantum offers the largest inventory, at great prices, delivered quickly.  
Tel (305) 687-0405  
Fax (305) 688-2790

**R**

**RAF ELECTRONIC HARDWARE 53**  
Electronic Hardware  
Tel (203) 888-2133  
Fax (203) 888-9860

**RAPID RIVET & FASTENER CORP. 215**  
Solid, semi-tubular, blind and drive rivets; rivet nuts, threaded inserts and wire inserts. Specialists in aerospace & commercial rivets.  
Tel (800) 727-4378  
Fax (631) 249-0401

**W.J. ROBERTS CO. 49**  
Spacers and standoffs. Hex and rounds 3/16 to 5/8 diameter. Standoffs in brass, aluminum, steel and stainless steel.  
Tel (781) 233-8176  
Fax (781) 231-1456

**ROTOR CLIP COMPANY, INC. IBC**  
Retaining rings, hose clamps & related products  
Tel (800) 557-6867  
Fax (732) 469-7898

**R&R ENGINEERING INC. 120**  
Bent bolts, wire forms  
Tel (800) 979-1921  
Fax (800) 345-9583

**RUELLE INDUSTRIES 213**  
The Easy-To-Use precision engineered screw identifier.  
Tel (248) 666-4433  
Fax (248) 666-1207

**RUMCO FASTENER DIVISION 171**  
Division of MW Industries, Inc. A leading cold-heading fastener manufacturer that specializes in a wide variety of SEMS and custom fastener products.  
Tel (800) 537-8626  
Fax (847) 364-4104

**S**

**SARJO'S FAS-KIT ASSORTMENTS 110**  
Complete line of fastener assortments customized with your company's information  
Tel (800) 44-SARJO  
Fax (845) 454-0070

**SCREW & SUPPLY CO. INC. 28, 221**  
Tamper-resistant security screws made in USA.  
Tel (800) 223-1316  
Fax (631) 567-3057

**SEASTROM MFG. 233**  
Broad product line including washers, clamps, brackets, spring clips, retaining rings, spacers, solder lugs & more!  
Tel (800) 634-2356

**SET SCREW & MFG CO. 242**  
USA manufacturer of slotted headless and square head set screws, fully threaded studs and miscellaneous screw machine products.  
Tel (847) 717-3700  
Fax (847) 717-3710

**SHEAR-LOC PRODUCTS 104, 181**  
The original instant thumbscrews. The ultimate socket head cap screw accessory  
Tel (800) 775-5668  
Fax (949) 768-8700

**S & M RETAINING RINGS 145**  
Div of Schneider & Marquard, Inc. Mfrs of retaining rings, applicators and dispensers.  
Tel (973) 383-2200  
Fax (973) 383-6529

**SMALLEY STEEL RING CO. 49**  
Manufacturer of spiral retaining rings, Spirawave® wave springs, and flat wire compression springs. Free engineering assistance for distributors.  
Tel (847) 719-5900  
Fax (847) 719-5999

**SOLON MANUFACTURING CO. 74**  
Solon belleville springs, Solon flange washers and Solon disc springs manufacturer. Online part search.  
Tel (800) 323-9717  
Fax (440) 286-9047

**SOLUTION INDUSTRIES 155**  
Tap bolts, screen bolts, dome plow bolts, tooth plow bolts, hex nuts, zinc plated socket products, and nylon patched products.  
Tel (866) 297-8656  
Fax (440) 816-9501

**SPECIALTY SCREW 261**  
Manufacturer of security screws  
Tel (626) 336-2900  
Fax (626) 336-2910

## SPECIALTY SCREW MANUFACTURING

Superior Quality Fasteners!  
With a Special Division of “Tamper Resistant Screws”  
- stock and made to order!

*The Pioneer in Screw Manufacturing!*

- Standard & Specials
- Inch & Metric
- Alloy & Stainless Steel
  
- Quick Delivery
- Volume Discount
- Competitive Pricing

**FOR A QUOTE...**  
**Call or Fax us Today!**



**SPECIALTY SCREW  
MANUFACTURING**

236 S. 8th Avenue  
City of Industry, CA 91746

Phone: 626/336-2900

Fax: 626/336-2910

E-mail: [sales@specialtyscrewmfg.com](mailto:sales@specialtyscrewmfg.com)



**We now stock!!!**



**[www. Specialtyscrewmfg.com](http://www.Specialtyscrewmfg.com)**

# ADVERTISERS INDEX

## S continued...

### SPIROL INTERNATIONAL CORPORATION 89, 197

Coiled and slotted spring pins, solid pins, disc springs, alignment dowels and bushings, spacers, compression limiters, machined nuts, threaded inserts and shims.  
Tel (800) 321-4679  
Fax (860) 774-0487

### SPRINGFAST CO. 211

Importer of tooth lock washers including specials. T-nuts, weld nuts, push on nuts, single thread locknuts and stud receivers.  
Tel (800) 344-7806  
Fax (401) 941-3730

### SRC SPECIAL RIVETS CORP. 249

Blind Rivets. Company rep Tony DiMaio.  
Tel & Fax (978) 521-0277

### STELFAST FASTENERS, INC. 71

Fastener importer specializing in nuts, washers and wheel attaching hardware.  
Tel (800) 729-9779  
Fax (440) 879-0044

### SUPERIOR BOLT & NUT 231

Stocking blanks 3/4" - 2-1/2" diameter. Offer quick delivery and fast quotes at competitive prices.  
Tel (602) 841-8100  
Fax (602) 841-6700

### SUPERIOR WASHER & GASKET 31

Stocking mfg. of washers, shims & small stampings  
Tel (631) 273-8282  
Fax (631) 273-8088

### SUPPLY LINE 86

MRO distributor supply warehouse  
Tel (800) 447-2756  
Fax (845) 454-0070

## T

### TAMPER-PRUF SCREW, INC 179

Security hex, torx, one way, drilled spanners.  
Tel (562) 531-9340  
Fax (562) 531-2464

### TRISTATE 239

T9 Nut, 180M PSI Proof Load, 4140 Alloy Steel. Works with High Strength Bolts.  
Tel (800) 410-4558

### TITAN FASTENER PRODUCTS 61

Quality packaged fasteners for distributors  
Tel (800) 789-8112  
Fax (912) 262-6401

### TRINITY HARDWARE HEADQUARTERS 160, 168, 185

Hex cap screws; round and square head bolts; #3, #4, and #7 head plow bolts; nuts (all types); flat and lock washers; threaded rod; storage pans and cabinets  
Tel (888) 232-1010  
Fax (563) 441-6760

### TUTTLE MANUFACTURING 255

Anchors, bent bolt specials, spade bolts, acme threaded bars  
Tel (847) 381-7713

## U

### UMETA OF AMERICA 110

OEM quality grease fittings and grease guns  
Tel (704) 799-1840  
Fax (704) 799-1923

### UNBRAKO 237

Unbrako socket screws, the most widely recognized fastener brand name in the world, are used in machine tools, tools and dies, earth moving and mining machinery, and a wide range of industrial and engineering applications.  
Tel (877) 669-9024

### UNIQUE INDUSTRIES 147

Manufacturer of specialty threaded items  
Tel (205) 668-0490  
Fax (205) 668-0431

### USA FASTENER GROUP 55

Full service job shop/manufacturing facility servicing the fastener industry. Specials and stand fasteners.  
Tel (713) 641-4600  
Fax (713) 641-4655

## V

### VIRGINIA FASTENERS 65

Specializing in hot dipped galvanized timber, hex, carriage, lag bolts, tie rods, nuts/washers.  
Tel (800) 368-3430  
Fax (757) 436-1460

### VMG ENGINEERING 205

Supplying the electronic hardware industry for over 23 years. Provide high quality and distinctive precision components. Offer a complete range of items from spacers, standoffs, male-females to any custom drawing specialty.  
Tel (818) 837-6320  
Fax (818) 837-6326

### VOGELSANG CORPORATION 99

Featuring Quick Ship - same day shipment on roll and coil pins, bushings. Maker of wide variety of pins, bushings, compression limiters, spacers and Engineered-RollPin™  
Tel (800) 526-2376  
Fax (732) 364-8111

### VOLT INDUSTRIAL PLASTICS, INC. FC, 16

Specializing in precision plastic fasteners, all types & quantities  
Tel (800) 844-8024  
Fax (870) 453-8707

## W

### WESTERN WIRE PRODUCTS 161

Cotter pins, wire fasteners  
Tel (800) 325-3770  
Fax (636) 305-1119

### WCL CO. 201

Lockwashers, flat and spring washers, threaded products, plastic components, customer specials.  
Tel (800) 331-3816  
Fax (626) 369-9805

### WILLIE WASHER MFG. 111

Special washers, stampings & prototype parts  
Tel (847) 956-1344  
Fax (847) 956-7943

### WROUGHT WASHER MANUFACTURING, INC. 91

Custom stampings & washers  
Tel (800) 558-5217  
Fax (414) 482-0144

### WYANDOTTE INDUSTRIES 191

Special hexagon nuts milled from bar  
Tel (734) 283-1870  
Fax (734) 283-6166

## Z

### Z-LINE INDUSTRIAL FINISHES 102

MRO finishes include: High Solids Enamel, Acrylic Enamels, Fast Dry Enamels, Welding Supplies, Cleaners/Degreasers, Spray Primer, Lacquers, Traffic Striping, Athletic and Field Marking, and Utility Marking Paints.  
Tel (800) 966-7580  
Fax (262) 255-0684

### ZONBIX ENTERPRISE CO., LTD. 45

Gathering fasteners into one shipment to save costs.  
Tel 886-7-6994364  
Fax 886-7-6994318

PWS'S BRAND NEW FACILITY IN CHINO, CA.



## COMMITTED TO DISTRIBUTORS. COMMITTED TO YOU.

Pacific Warehouse Sales has long been the go-to supplier for distributors. In fact, we've worked solely with distributors for nearly 30 years now. As a family business, we pride ourselves on our attention-to-detail, vast product portfolio and commitment to customers of every size and need.

### PWS'S WIDE RANGE OF ITEMS

- Rivets – Blind, Closed End, Multigrip
- ACT Fastening Solutions Cable Ties and Accessories
- Spirol® Slotted Spring Pins and Coiled Pins
- Western Wire Products Cotter Pins, Hitch Pins and Wire Products
- G.L. Huyett Clevis Pins, Keystock, Machinery Keys
- Taper Pins
- Sherex® Rivet Nuts
- Powercoil® Wire Thread Inserts
- ITW Devcon® /Permatex® Adhesives, Metal Repair, Lubricants, Cleaning Products
- KMC® Clamps – Vinyl Dipped & Rubber
- Camcar® LLC Socket Products
- Krylon® Industrial Paints and Lubricants
- Prestige Stamping Domestic Through Hardened Washers.



### PACIFIC WAREHOUSE SALES

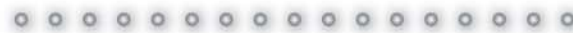

15368 EL PRADO ROAD  
CHINO, CALIFORNIA 91710

PHONE #909-287-7750 FAX #909-287-7755

TOLL FREE FAX #800-874-0587

E-MAIL: SALES@PACIFICWAREHOUSES.COM WWW.PACIFICWAREHOUSES.COM

THE  
DISTRIBUTOR'S

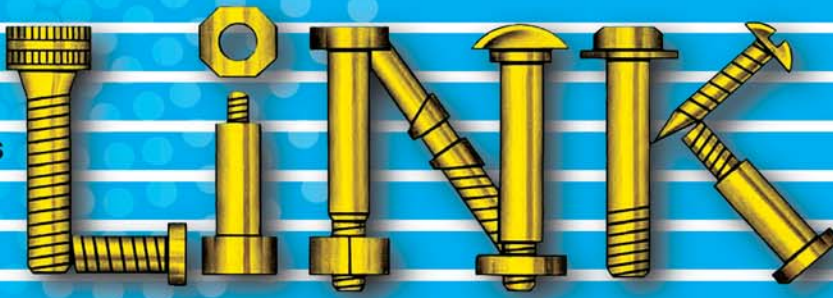

Follow Us on  
**Twitter**

submit your industry news online with  
our new press release upload tool.



visit [www.linkmagazine.com](http://www.linkmagazine.com)  
and look for the big red button.

# Exploring The World of Rotor Clip

USA    England    Czech Republic  
Germany    China

Retaining Rings  
Spiral Rings  
Wave Springs  
Hose Clamps

[www.rotorclip.com](http://www.rotorclip.com)

VISIT US AT THE  
NATIONAL INDUSTRIAL FASTENER & MILL SUPPLY EXPO  
BOOTH #1001  
OCTOBER 11<sup>TH</sup> & 12<sup>TH</sup>, 2012  
SANDS EXPO CENTER, LAS VEGAS

**R** ROTOR CLIP<sup>®</sup>

*Designed for Quality*

# Our Business is Understanding Yours

## BBI: The Value-Driven, Global Leader in Fastener Distribution

### • Expanding Distribution Centers:

- BBI Los Angeles distribution center has expanded an additional 90,000 sq. ft.
- BBI Dallas distribution center has expanded into an 180,000 sq. ft. facility.
- BBI Chicago distribution center will be expanding into a new 257,000 sq. ft. facility by the end of 2012.

### • Expanded Product Lines:

BBI is adding over thirty new product lines this year, including a complete line of Anchor and Screw Products. Distributors can now combine more of their purchases to consolidate shipments, decreasing their shipping costs while increasing their productivity. Brighton-Best delivers the most complete line of fastener products in the industry.

### • Expanded Packaged Offerings:

Distributors face many challenges in a competitive market. When buying in bulk does not fit your specific needs, our expanded offering of packaged products allows distributors to purchase in quantities that meet their requirements. Brighton Best International offers the distributor the ability to get our full line of products including low carbon, stainless steel, sockets and hex head products packaged from a single source; buying from BBI just got easier.

**NEW**

### • Expanded Ready Mill:

#### Hex / Structural Program will include:

- A325 Structural Bolts Plain and HDG
- A325 TC Bolts Plain
- Grade 5 HCS Plain and Plated
- Grade 8 HCS Plain and Plated

#### Threaded Rod Program will include:

- A307 Threaded Rods Zinc and Plain

#### Washer Program will include:

- USS Washers: Plain / Plated / HDG
- SAE Washers: Plain / Plated
- Fender Washers Plated
- F436 Washers Plain / Plated / HDG



# BRIGHTON-BEST INTERNATIONAL

www.brighton**BEST**.com • 1 - 8 0 0 - 2 7 5 - 0 0 5 0

Please Visit Us at 2012 National Industrial Fastener & Mill Supply Expo **October 10 - 12, 2012 Booth# 818**

USA • Atlanta, GA • Boston, MA • Charlotte, NC • Chicago, IL • Cincinnati, OH • Cleveland, OH • Dallas, TX • Detroit, MI • Houston, TX • Logan Township, NJ  
• Los Angeles, CA • Maple Grove, MN • Miami, FL • Nashville, TN • Portland, OR • San Francisco, CA • Sayreville, NJ • Seattle, WA • St. Louis, MO • Tampa, FL  
CANADA • Edmonton, AB • Montreal, QC • Toronto, ONT • Vancouver, BC