

THE
DISTRIBUTOR'S

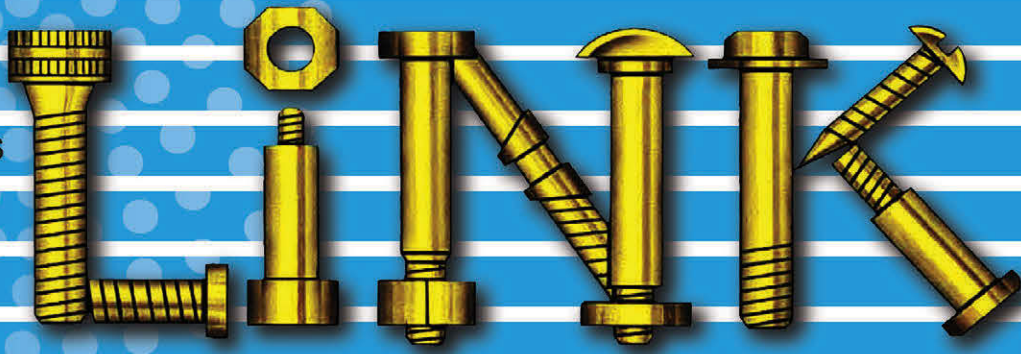

THE NATIONAL MAGAZINE FOR FASTENER DISTRIBUTORS



XL SCREW CORPORATION



READ OUR STORY ON PAGE 16



HIT THE FASTENER JACKPOT!

WITH

ND[®]
INDUSTRIES

ADVANCED FASTENING & SEALING TECHNOLOGIES

No matter what the application is, how it needs to perform, or where you need it supplied, our fastener adhesives and sealants will give you a big payout!



www.ndindustries.com

Professional Grade Fasteners

Call us today
to receive your
FREE catalog!

STRONG-POINT[®]

Experience the Difference
with **STRONG-POINT**[®]
Premium Quality Fasteners

STRONG-POINT *Self-drilling*



STRONG-POINT *Needle Point*



STRONG-POINT *Stainless*



STRONG-POINT *DryWall*



STRONG-POINT *Outdoor*



STRONG-POINT *Cement Board*



STRONG-POINT *Strongcon*



STRONG-POINT *Woodworking*



STRONG-POINT *Polegripper*



STRONG-POINT *Special Application*



INTERCORP 
www.intercorpusa.com

Los Angeles
800.762.2004

New York
888.322.2262

Chicago
800.533.9669

Dallas
800.558.7222

Atlanta
800.822.9690

Portland
800.434.5606

Houston
800.558.7222

Cleveland
800.533.9669

Miami
800.822.9690

METRIC MASTERS

Your Complete Metric Source

Lindstrom's heritage lies in industry leading Metric inventories. Continual efforts to better serve customers have seen the addition of expansive Standard Inch and Class C product lines, but Lindstrom has always stayed true to its roots, continuing to lead the way with the broadest and deepest metric inventories in North America.



- HEX HEAD CAP SCREWS
- SOCKET HEAD CAP SCREWS
- FLAT SOCKET CAP SCREWS
- BUTTON HEAD CAP SCREWS
- LOW HEAD CAP SCREWS
- HEX FLANGE BOLTS
- PHILLIPS PAN HEAD MACHINE SCREWS
- PHILLIPS FLAT HEAD MACHINE SCREWS
- SLOTTED CHEESE HEAD MACHINE SCREWS
- SLOTTED PAN HEAD MACHINE SCREWS
- SLOTTED FLAT HEAD MACHINE SCREWS
- HEX JAM NUTS
- FULL HEX FLANGE NUTS
- NYLON INSERT LOCKNUTS
- ALL-METAL LOCKNUTS
- KEPS LOCKNUTS
- ACORN NUTS
- FENDER WASHERS
- SPLIT LOCK WASHERS
- WAVE WASHERS
- TOOTHED WASHERS
- SERRATED WASHERS
- THREADED RODS
- FLAT POINT SOCKET SET SCREWS
- CUP POINT SOCKET SET SCREWS
- FLAT WASHERS
- HEX NUTS



JIS METRIC FASTENERS FOR INDUSTRY

JAPANESE INDUSTRIAL STANDARD PRODUCTS
AVAILABLE FOR IMMEDIATE DELIVERY FROM OUR STOCK
PACKAGED AND DELIVERED PER CUSTOMER REQUIREMENTS



DIRECT ACCESS TO BN PARTS

RAPID ACCESS TO SPECIAL FASTENERS
UTILIZE OUR UNIQUE AIR FREIGHT PROGRAM
AVAILABLE IN STOCK OR WITHIN 4 TO 5 DAYS



BY ANY MEASURE.

www.lindstromfasteners.com

*Your master-distribution
connection to convenience,
choice, value and flexibility*



Minnesota
1-800-328-2430

South Carolina
1-800-572-5550

Illinois
1-800-837-5858

Toronto
1-800-668-2632

email
sales@lindfastgrp.com

Now Stocking Baytite Rivets
(Gesipa Bulbtite® Equal)
And New Line Of
Recoil Tangless® Fasteners

YOUR CUSTOMERS DEMAND THESE TOP BRANDS

WE STOCK ALL OF THEM FOR YOU



NEW PRODUCT LINES:

- NAS/MS RIVETNUTS
- FAR RIVETING AND INSERT TOOLS (COMPLETE LINE)

**EXCLUSIVE STOCKING
DISTRIBUTOR
RECOIL/ARCONIC
[ALCOA] TANGLESS
COIL-THREAD INSERTS
& TOOLS**

Bay Supply.com

Your Other Warehouse

Bay Supply is a Division of Bay Fastening Systems

America's Largest Engineered Fastening Supply Warehouse

30 Banfi Plaza North, Farmingdale, NY 11735 • 516.294.4100 • fax: 516.294.3448
info@baysupply.com • Baysupply.com

8 SCREW THREADS – A SOURCE FOR CONFUSION AND CHAOS

Bengt Blendulf

10 WHAT FASTENER DISTRIBUTORS NEED TO KNOW ABOUT THE PROCESSING OF STEEL FASTENERS

Guy Avellon

12 IN RECRUITING, AI GETS REAL FOR FASTENER DISTRIBUTORS

Joe Dysart

14 THREE THINGS THAT DISTRIBUTORS MUST DO WELL – PART 2: QUALITY

Laurence Claus

16 [COVER STORY] XL SCREW CORPORATION – THE NAME YOU CAN COUNT ON

24 WHAT FASTENER SUPPLIERS NEED TO KNOW ABOUT CALIFORNIA'S PROPOSITION 65

Carmen Vertullo

26 FASTENER COMPANY ACQUISITIONS COMPLETED DURING FIRST HALF OF 2018

Richard Hagan

28 IFI NAMES DAN WALKER AS MANAGING DIRECTOR

30 EXHIBITORS COMMITTING EARLY TO SHOWCASE SOLUTIONS AT FASTENER FAIR USA 2019

Lauren Oscarson

32 SOLUTION'S SOLUTION

34 COMPUTER INSIGHTS: HOW GOOD IS YOUR USER SECURITY?

35 FASCOMP ELECTRONIC HARDWARE CONTINUES TO EXPAND AND DEVELOP

36 INTERNATIONAL FASTENER EXPO 2018 SHOW PREVIEW

38 AMERICAN FASTENER RIDER TOURS AUSTRALIA FOR DUCHENNE MUSCULAR DYSTROPHY

Jim Ruetz

40 THE ISO 9001 TRANSITION IS OVER, NOW WHAT?

Lorri Hunt

44 INFRASTRUCTURE REBOOT CAN'T WAIT!

Jim Truesdell

48 IFI BOOK OF FASTENER STANDARDS 2018 EDITION

Salim Brahimi

50 CERAMCO, INC: DEMYSTIFYING SOLID CERAMIC FASTENERS – SOLID CERAMIC FASTENERS 101

52 U.S. FASTENER MANUFACTURERS GET INCONSISTENT 232 TARIFF WAIVER RESPONSES

John Wolz

54 INTERNATIONAL FASTENER EXPO ANNOUNCES 2018 AWARD WINNERS

56 PRE-PLANNING CAN SAVE YOUR BUSINESS AND YOUR LIFE

Robert Footlik

58 NFDA NEW MEMBER DEAL: SAVE 50%

Vickie Lester

60 DISTRIBUTION ONE: DISTRIBUTOR TOOLS FOR HARNESSING THE POWER OF AMAZON

62 STAFDA'S PHOENIX CONVENTION RISING TO THE OCCASION

Georgia Foley, CEO

66 GOEBEL FASTENERS: CELEBRATING 40 YEARS OF TOP QUALITY PRODUCTS AND SERVICE

68 CALL FOR WOMEN IN THE FASTENER INDUSTRY VOLUNTEERS!

70 BLIND RIVET SPECIFICATIONS

Anthony Di Maio

74 BOLTED JOINT CONSISTENCY WITH STAINLESS STEEL FASTENERS

Derek Dandy

76 SURFACE MOUNT FASTENERS FOR PRINTED CIRCUIT BOARDS

Michael J. Rossi

77 CHICAGO HARDWARE: DOMESTIC MANUFACTURER OF STEEL WIRE FORM FASTENERS

78 EFC INTERNATIONAL: THE EFC DIFFERENCE

80 MFDA AWARDS 2018 SCHOLARSHIPS

Nancy Rich

88 MARTIN SUPPLY DEVELOPS INNOVATIVE ONLINE QUOTING TOOL

Anthony Crawl

90 BRIGHTON-BEST'S PEOPLE & PLACES

92 STOCK PURCHASE? ASSET PURCHASE? OR BOTH?

Roman Basi

93 BTM MANUFACTURING AWARDED ISO 9001:2015

94 THE EVOLUTION OF DYNACAST INDUSTRIAL PRODUCTS – MORE THAN JUST DIE CAST FASTENERS

96 HOW TO CHOOSE A QUALITY SUPPLIER

Anthony Brigandi

98 HOW DEFLECTION RANGE AFFECTS THE PERFORMANCE OF DISC SPRINGS

John Leckfor

100 FAR SRL: OVER 60 YEARS OF ITALIAN EXPERIENCE IN THE FASTENING WORLD

104 BRICO – BRIGHT NAME IN MIDWEST MANUFACTURING

106 MW INDUSTRIES, INC: CUSTOMER-CENTRIC AT OUR CORE

108 KEVIN CHAVIS RE-ELECTED PAC-WEST PRESIDENT

Vickie Lester



- 110 **INXSQL: BUILT FOR SUCCESS**
- 114 **MWFA FASTENER SHOW DELIVERS**
Nancy Rich
- 115 **MWFA TABLE TOP SHOW PHOTOS**
- 118 **BEACON FASTENERS: CUSTOM-MADE PROGRAMS MAKE IT ALL SO EASY!**
- 124 **SPACE CITY SCREW: 25 YEARS OF SERVICE AND TRUST**
- 131 **FTI LAUNCHES ONLINE LEARNING LIBRARY**
Jo Morris
- 151 **SUBSCRIPTION FORM**
- 160 **NEFDA GOLF OUTING A GREAT SUCCESS**
Nancy Rich
- 161 **NEFDA GOLF OUTING PHOTOS**
- 162 **SEFA IS HEADING TO THE BEACH IN 2019!**
Nancy Rich
- 163 **NARRAGANSETT SCREW COMPANY RECEIVES ISO 9001:2015 CERTIFICATION**
- 166 **FASTENER INDUSTRY LINKS**
- 176 **HWC AND VERTEX: ALIGNED TOGETHER SERVING DISTRIBUTORS ONLY**
- 179 **ZAGO HIGH-TECH SEALING SOLUTIONS & COMPONENTS**
- 182 **MWFA GOLF OUTING – FUN NETWORKING AFTER SHOW!**
Nancy Rich
- 183 **MWFA GOLF OUTING PHOTOS**
- 190 **FASTENER TECH '19 REGISTRATION INFO**
Nancy Rich
- 192 **BAY SUPPLY ANNOUNCES IT IS NOW A FULLY AUTHORIZED DISTRIBUTOR FOR FAR FASTENERS**
- 195 **PAC-WEST FALL CONFERENCE PHOTOS**
- 202 **KELLY COLE ELECTED NFDA PRESIDENT FOR 2018-2019**
Vickie Lester
- 216 **ISSCO EMPLOYEE RECOGNIZED AS TOP 30 IN 30 PARTNER FOR WAREHOUSE1**
- 219 **CHRISLYNN THREADED INSERTS: BE A HERO – SAVE THE DAY**
- 224 **JIM RUETZ AWARDED NFDA'S 2018 FASTENER PROFESSIONAL OF THE YEAR**
Vickie Lester
- 237 **MFDA SCHOLARSHIP PHOTOS**
- 247 **MAKE ADVERTISING YOUR PRIORITY FOR 2019**



Leo J. Coar
EDITOR & PUBLISHER
leojoar@linkmagazine.com



Tracey Lumia
SALES & MARKETING DIRECTOR
tracey@linkmagazine.com

DISTRIBUTOR'S LINK MAGAZINE IS A QUARTERLY PUBLICATION DEDICATED TO REPORTING, EDUCATING, AND PROMOTING THE FASTENER INDUSTRY SINCE 1976.



PRINT



ONLINE



APP



CONNECT WITH US

ALL RIGHTS RESERVED. NO PART OF THIS PUBLICATION MAY BE REPRODUCED WITHOUT PERMISSION OF THE PUBLISHER. SUBSCRIPTION PRICE: \$50 USA, \$60 CANADA, \$70 ALL OTHERS. EDITORIAL REPRINTS AVAILABLE UPON REQUEST. INQUIRE ABOUT CHARGES. PUBLISHER'S NOTICE: DISTRIBUTOR'S LINK MAGAZINE ASSUMES NO RESPONSIBILITY FOR VALIDITY OF CLAIMS IN CONNECTION WITH ITEMS APPEARING IN OUR MAGAZINE.

DISTRIBUTOR'S LINK INC.

4297 Corporate Square, Naples, FL 34104

TEL 1-800-356-1639 OR 239-643-2713 FAX 239-643-5220

www.linkmagazine.com

DESIGN AND PRODUCTION OF LINK MAGAZINE PROVIDED BY



224-489-9533 • www.GRAPHIKACREATIVE.com

distributornews

North East Fasteners (NEF) is forging into many new initiatives these days, such as the implementation of a comprehensive “Best Practices Training Program.” Where indispensable knowledge from highly experienced operators is being collected, broken down and retained for future consumption using multiple formats. This way NEF can more efficiently communicate the “trade secrets” to our next generation of machinists.

In addition, NEF has begun cross-training their employees in all departments, in order to expand employee’s knowledge, skills and understanding. This also helps NEF to handle risk management more robustly and with more flexibility.

A major project that NEF is now developing, is a highly sophisticated Internal Communications System, which will act as an informative heads-up display. The “NEF ICS” will have the ability to relay any critical information in any format (PDF, Video, Graphic, etc.) to any location at any time. The key is that any event within the ERP system can determine when and where the customizable communication should be triggered. For example, when an operator begins to set up a particular job,

he/she may reach a point where specific pictures and instructions will pop up and guide that individual to a best practice for that specific job. This system will encompass every aspect of the ERP system including but not limited to, quoting, order entry, production, quality and shipping. The potential benefits are significant.

Additionally, North East Fasteners is pleased to announce the accomplishment of attaining ISO 9001: AS9100 Rev D certification.

North East Fasteners is committed to upholding world-class quality standards through the relentless pursuit of exceeding customer expectations. NEF is AS9100/ ISO 9001:2015 certified with a 100% standing for 8 years running. It is also an QSLM Levels 2/3 certified supplier, serving the commercial, military, aerospace and automotive markets. NEF is currently producing a size range of -00- to number 10 diameter fasteners in all types and classes, as well as M1.2 to M4.5 (metric), up to 2 inches (50mm) long.

For more information contact North East Fasteners by Tel: 860-589-3242, Fax: 860-589-6969, email: nef@nef1.com or visit them online at www.nef1.com.

* * * * *

On June 7th, 2018, **SWD Inc.** held a groundbreaking ceremony to celebrate a 26,000 sq. ft. expansion of their existing 160,000 sq. ft. facility. In attendance were Village of Addison Officials, representatives from BMO Harris Bank, and members of Laub Construction. With this addition, SWD projects growth of 15% in year-over-year sales and expects that anywhere from 12-15 new positions will be created.

The current expansion is the second phase of a project that added 60,000 sq. ft. in 2012. The extra 26,000 sq. ft. will help with process flow in this state-of-the-art coating production facility. It has been designed to allow for more warehousing with an automated racking system for part storage along with new office space for centralized shipping, receiving, and order entry processing.

The \$3million addition follows a series of investments. This expansion is aligned with SWD’s mission to “Bring our customers the highest level of quality and service in the metal finishing industry”. SWD Inc. specializes in Black Oxide, Passivation of Stainless Steel, Phosphate coatings (Zinc, Manganese & Iron), Fastener Sorting and licensed application of High Corrosion Magni, Dörken and Yuken coating systems. Last year, SWD introduced a state-of-the-art robotic organic coating line with unprecedented production capabilities.

This project is expected to take six months and should be finished by November 2018.

For more information, contact SWD Inc. by Tel: 630-543-3003, Fax: 847-885-9005, Email: sales@swdinc.com or visit them online at www.swdinc.com.

AMPG

BEAUTIFUL PARTS, RIGHT NOW

316 H5

Super corrosion resistant | High strength



Shoulder Screws,
Socket Screws, Flat
Washers, Flange
Nuts, Hex Nuts



Made Here, Available Now

26 Swiss Lathes running 24/7/365
with 10 more machines on the way



Learn more at AMPG.COM or call 317.472.9000

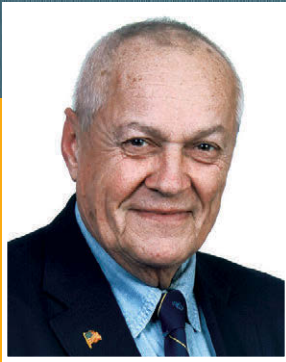

Bengt Blendulf

Bengt Blendulf was educated in Sweden and moved to the US in 1974 to start a subsidiary for a Swedish fastener manufacturer. After working as a technical consultant on the faculty of the College of Engineering and Science at Clemson University, he established EduPro US in 1997 to teach highly rated courses in Fastening Technology in the US, Canada, Mexico, Europe and Asia. Being one of the founders, Bengt served as the chairman of ASTM F16.96 Bolting Technology from 1996 to 2006. In 2006 he received the Fred F. Weingruber award from ASTM for "his efforts to promote and develop standards for the fastener industry." In 2013 he also received IFI's Soaring Eagle Award for "significant contributions to the technological advancement of the fastener industry". Bengt is the author of an extensive lecture book, well over 110 articles and "Mechanical Fastening and Joining", a book published in 2013 by the Industrial Fasteners Institute. He can be contacted through www.edupro.us or by email bblendulf@yahoo.com.

SCREW THREADS – A SOURCE FOR CONFUSION AND CHAOS

ASME has the following definition of the screw thread; "a screw thread is a ridge of uniform section in the form of a helix on the external or internal surface of a cylinder". Sounds easy enough! Most of us would likely prefer the definition given by a young elementary class student: "a thread is a scratch wrapped around a pin". I think the majority of us would prefer the "scratch" definition even if it is slightly out of specification.

Anyway, all threads are not intended as "screw threads" as in fasteners. In preparation for this article, I have been able to identify as many as 246 different types (not number of sizes) of threads (profiles, tolerances, usage areas etc.) of which a slight majority can be placed in the fastener family folder. This enormous variety of thread types is mostly the result of non-existing national and international standard efforts in earlier years, individual designers need to show-off for colleagues, narrow branch related needs and so on. Today's designers are better off looking at standards published by ISO and ASME when choosing thread types for fasteners, or they will create lots of trouble for purchasing and vendors and will likely be fired in the process. With most of our industrial production going to an increasingly larger market area, the need for interchangeability of replacement parts is driving simplification.

Let's go back some years to see how engineers have tried to find the best way of designing and define threads.

Archimedes, the famous Greek mathematician (287-

212 BC), has been given credit for "inventing" the screw thread. What he actually did (apart from giving us the value of and how to calculate the area and volume of the sphere) was to develop, maybe with some help from Egypt, a "screw-pump" in the shape of a spiral shaped pipe on an inclined plane with open ends. When cranked he could rise water through the pipe to a higher level to bring it to fields for growing wheat and other food sources.

The Roman wine makers were using large, hand-made, wood screw designs to compress grapes and olives for processing or juices and wines. Sure beats using your feet stomping around with bare feet in the grapes at tarantella music from an accordion.

Leonardo da Vinci (1452-1519) tried his considerable mind to develop metal screw threads, but he gave up due to the complexity of making the machinery for production. This is strange due to the fact that he was designing the Viola Organista in 1488, a musical instrument with very high complexity (and with two operators), and of course being busy painting the Mona Lisa.

In 1797, Henry Maudsley, a British engineer, invented the master spindle lathe with a long lead screw that would guide the cutting tool assembly to a very precise path over the rotating work piece. One of his apprentices, Joseph Whitworth (in 1841 Sir Joseph Whitworth) found the idea intriguing and made it possible to make, with the Maudsley lathe, like parts over and over again. He invented the "Mother" of all bolt and nut threads, the W or Whitworth.

PLASTIC FASTENERS • AMERICAN MADE • WORLDWIDE • IN-HOUSE TOOLING

VOLT

EXCLUSIVE

Hottest New Must Have
Plastic Cable Clamps
from Volt Plastics

UPDATED

VoltPlastics.com...
Request A Quote Online
All New, User Friendly Design

COLOR

Want Fall Colors?
We Color Match For
Specific Applications!

AN INDUSTRY LEGEND

Joe Volltrauer Turns 80
40+ Years in the Industry
Leading Volt Plastics to Success

VoltPlastics.com
800.844.8024
#WeAreVolt





Guy Avellon

Guy Avellon has been in MRO and Fastener Distribution for over 30 years, in such positions Sales Engineer, Chief Engineer, Manager of Product Marketing, Product Engineering & Quality and Director of Quality & Engineering. He founded GT Technical Consultants where he performs failure analysis, lectures on fastener safety, works for law firms and designs/audits Quality systems. He is a member of SAE, is Vice Chairman of the ASTM F16 Fastener Committee, Chairman of the F16.01 Test Methods Committee and received the ASTM Award of Merit in 2005. Guy can be contacted at 847-477-5057, Email: ExpertBoltGuy@gmail.com or visit www.BoltFailure.com.

WHAT FASTENER DISTRIBUTORS NEED TO KNOW ABOUT THE PROCESSING OF STEEL FASTENERS

Many times, you can see trucks on the highways with large coils of steel wire of different diameters on them. They are going to a fastener or nut manufacturer. When the raw steel coils arrive at the manufacturers, they are generally stored outside and are exposed to the weather. However, their heat-treat scale prevents heavy rust from forming.

When ready for use, the first step is a cleaning operation called "pickling". The steel is cleaned in a solution of sulfuric acid, which removes superficial rust and other surface contaminants. Pickling is followed by cleaning, where the wire is rinsed to remove any remaining acid, and subsequently coated with a lubricant, such as a lime or phosphate solution. This coating acts to neutralize any residual acid. It also helps prevent corrosion if the steel is not used immediately, and increases the ability of the steel to pick up the lubricant used in the bolt-making machinery.

Spheroidizing

Spheroidizing is a form of annealing and is the first heat treating process to which the cap screw material is subjected. This operation 'globularizes' the microstructure of the steel and is modified into an elongated pattern when the steel is upset during deformation of the bolt in the forming operation.

Spheroidizing increases the pliability of the steel and makes it easier to be cold formed to produce a consistent

and reliable product. This annealing process is carried out in a hermetically sealed oven that is purged with nitrogen gas. This eliminates the possibility of carburization or decarburization during this annealing phase. However, the steel is very susceptible to decarburization during the final heat treatment. Carburization or decarburization is the gain or loss of surface carbon, which would adversely harden the threaded surface by increasing brittleness or soften the surface, respectively, thereby decreasing its ultimate load capability and functionability.

In the sealed oven, the iron-based alloy is heated near the critical temperature to approximately 1600°F (870°C) for 24 to 48 hours, during which time it slowly cools so that the iron carbide forms a pearlitic structure of ferrite and carbide, Fe_3C , and assumes a microscopic spheroid form. Some grades of fasteners may use a process anneal. After annealing, the wire is tested for proper microstructure, re-cleaned, and re-limed. It is now ready for the bolt-maker.

Normalizing is different than stress relief annealing, though sometimes the two terms become confused. Stress relief annealing, or subcritical annealing, is changing the distorted cold-worked crystal lattice structure back to one which is strain free by heating the material to below the lower critical line; 1,000 to 1,200°F (538 to 650°C). Normalizing, when used, is performed at 100°F (38°C) above the upper critical temperature of the steel.

NEF

*A Tradition
of Precision*



2



5



6



9/10



8



7



4



1

*We're everywhere
you need us to be!*



Commercial | Military | Aerospace | Automotive | Specials

NORTH EAST FASTENERS

8 Tremco Dr., Terryville CT 06786 Ph: 860-589-3242 | Fax: 860-589-6969



Joe Dysart

Joe Dysart is an Internet speaker and business consultant based in Thousand Oaks, California. A journalist for 20 years, his articles have appeared in more than 40 publications, including The New York Times and The Financial Times of London. During the past decade, his work has focused exclusively on ecommerce. Telephone: 631-256-6602; web: www.joedysart.com; email: joe@joedysart.com.

IN RECRUITING, AI GETS REAL FOR FASTENER DISTRIBUTORS

While the wonders of artificial intelligence are often hyped beyond recognition, AI-powered recruitment software is actually offering real advantages to fastener distributors.

Scores of firms across all industries are currently using AI-driven recruitment software to automatically crawl the Web for the kind of job candidates they want, auto-interview them via text chat or video on-the-spot, and then auto-schedule the most promising candidates for follow-up interviews by the person who does the hiring.

Other programs automatically rifle through resumes submitted at a fastener distributor Web site for candidates with the exact qualifications you want.

And still others design neuroscience games your job candidates can play, which glean the people who best exhibit the traits, skills and characteristics you're looking for.

"Artificial Intelligence has the potential to deliver what recruiting has been craving for – find more and better candidates, and reduce time and cost to hire," says Shobhit

Gupta, business strategy and operations lead, AllyO (www.allyo.com) an AI-driven recruiting software package.

AI recruiting software has also become wildly popular. According to a 2018 survey by business consulting firm Korn Ferry, 63% of HR pros say AI has already changed the way they recruit – and 69% say that AI has helped them source better candidates ([www.kornferry.com/press/korn-](http://www.kornferry.com/press/kornferry-global-survey-artificial-intelligence-reshaping-the-role-of-the-recruiter)

[ferry-global-survey-artificial-intelligence-reshaping-the-role-of-the-recruiter](http://www.kornferry.com/press/kornferry-global-survey-artificial-intelligence-reshaping-the-role-of-the-recruiter)).

Given the stir AI recruiting has created, fastener distributors will want a representative sampling of what you can do with AI recruiting software right now:

- **Robot Vera** (ai.robotvera.com) A chatbot recruiter, Robot Vera can be embedded on your Web site to instantly interview people who submit resumes or apply for a job with your company in similar ways.

Core to the application is a self-learning neural network, which was initially trained to chat with people by reading Wikipedia, 'watching' TV shows and studying countless help wanted ads and job interview questions.

Moreover, each time Robot Vera interacts with a person, it's programmed to learn from that experience and be smarter chatting with the next person.

The software can also automatically scan for resumes on job sites, phone candidates with the right qualifications and propose an

interview on-the-spot. Also, Robot Vera is relentless: It can make up to 10,000 phone calls simultaneously.

- **VCV AI** (<https://vcv.ai>) Similar to Robot Vera, VCV can screen hundreds of thousands of resumes for a fastener distribution firm to find the kind of staff you're looking for, and then reach out to prospective clients, offering either an online chat or phone call as an interview format.



AI RECRUITMENT SOFTWARE IS AUTOMATING THE SEARCH FOR PRIME JOB CANDIDATES -- AS WELL AS THE PRELIMINARY INTERVIEWS.

(IMAGE SOURCE: PIXABY ([HTTPS://PIXABY.COM](https://pixabay.com)), DISTRIBUTOR OF ROYALTY FREE IMAGES THAT ARE FREE FOR COMMERCIAL USE.)



A KEY COMPONENT OF ENTELO'S SOFTWARE IS AN AI-DRIVEN WEB CRAWLER, WHICH LOOKS INTO EVERY NOOK AND CRANNY OF THE WEB FOR JOB CANDIDATES, ACCORDING TO GAURAV KATARIA, ENTELO'S VICE PRESIDENT PRODUCT.



SINCE 1963

METRIC & MULTISTANDARD COMPONENTS CORP.

The Distributor's Master Stocking Metric Resource

**FASTENERS
WRENCHES**

**FITTINGS
TUBING**

**CUTTING TOOLS
MEASURING TOOLS**

**ASSORTMENTS & SETS
SPECIALTY ITEMS**

The #1 Distributor Program
VOLUMETRICSSM
Volume Savings,
Private Brand Labeling & more!
Only for Distributors
CALL NOW!



www.METRICMCC.com

888-966-6622

NEW YORK
800-431-2792

GEORGIA
800-444-9560

ILLINOIS
800-221-4469

TEXAS
800-527-5177

NEVADA
800-786-4599



ISO 9001:2008 CERTIFIED



Laurence Claus

Laurence Claus is the President of NNI Training and Consulting, Inc. He has 25 years of experience with a medium sized automotive fastener manufacturer, holding positions including Vice President of Engineering, General Manager, Director of Quality, Director of New Business Development and Applications Engineer. In 2012 he formed NNI offering technical and business training courses as well as technical consulting, expert witness and consultation work. He can be reached at 847-867-7363 or by email: Lclaus@NNITraining.com. You can learn more about NNI at www.NNITraining.com.

THREE THINGS THAT DISTRIBUTORS MUST DO WELL - PART 2: QUALITY

This three part series seeks to explore three things that fastener distributors must do well. In fact, failure to do any one of these three things well exposes the organization to short-term problems and, if not addressed, potentially eventual ruin.

In Part One we looked at how Customer Service, when done right can set an organization out in-front of the pack but cripple those organizations that don't do it well. We looked at how customer service has a strong potential of leaving lasting impressions both good and bad. These impressions often lead to actionable reactions, meaning that a positive experience may result in increased dependency, trust, and turnover for the organization, while a less than positive experience can generate loss of trust, reputation, and business.

In this second installment we are going to look at quality. Much like customer service, providing excellent quality will bring out positive feelings by your customer while providing poor quality products or by not responding well to a quality spill will land you in pretty much the same boat as poor customer service. Therefore, it is extremely important to develop attitudes toward quality that promote prevention, build processes that are understood and controlled, and encourage proactive and expedient resolution to emerging problems.



What is Quality?

Answering the question, "what is quality?" is perhaps a loaded one and one which has different answers depending on your perspective. However, when we consider the question strictly from a manufacturing point of view, one might answer that a quality part is one that is "in specification". This interpretation, however, ices the same "value" and performance expectations on the part regardless of whether it is made at the middle, low, or high end of the specification band. In other words, this scenario assumes that a part will perform the same when centered at the ideal target specification value as it will when made at its absolute highest or lowest limit.

Although not necessarily a wrong assumption, it is easy to understand that parts made at their extreme limits may not perform the same way as a part centered in the middle.

In the early 1970s renown Japanese quality expert, Genichi Taguchi, proposed his Taguchi Loss Function. This theory essentially says that the "value" one receives from a product or service begins to diminish as you deviate from the ideal target. To illustrate this, imagine a banana. From time to time we all enjoy eating this or some other delicious piece of fruit. We know from experience that there is an ideal ripeness to a banana, when it is absolutely most satisfying. In this example, let's say that is on Day 5.

**Ford 410
Self-drilling
Stainless
Steel Screws
are pointing the
way to 55 years of
superior holding
power.**



SELF-DRILLING



**FORD
FOR 410**

SELF-DRILLING • EPDM SEALING WASHERS • SELF-PIERCING • SELF TAPPING

**ADDITIONAL SERVICES AND CAPABILITIES:
1000 Hour Coating is available
EPDM and Neoprene bonded sealing washer assembly
ASK ABOUT OUR FREE FREIGHT POLICY
Same Day Shipping**



www.fordfasteners.com

CALL FORD FOR 410: 1-800-272-3673 (FORD)



XL SCREW CORPORATION

OUR HISTORY

XL Screw Corporation was founded on November 22, 1968 by Norman Sackheim (1915-1972). However, the seeds of our beginnings were planted thirty-some years before our actual founding date. In the late 1930's, Norman's father, Ben J. Sackheim (BJ) founded Stronghold Screw Products, Co., a manufacturer of fasteners in Chicago. Even as late as the mid 1990's, you could still see the original advertising printed on the old Stronghold Screw building at 216 W. Hubbard in Chicago. Many Chicagoans riding the "EL" train passed by the building and probably had to take a second look when they saw the caption that read "Screws & Nuts To You."

Norman and BJ worked together for over 15 years. A few years after the end of WWII, Norman believed the time had come to start importing standard fasteners. Norman believed that Stronghold's machine time should be reserved for making sophisticated items and the garden variety stock items should be imported. BJ didn't buy that concept, so Norman left Stronghold Screw in the early 1950's and started his own import company in 1953 called Heads and Threads, which became one of the first stocking



*Narrated by Bob Sachs - President,
CEO & Owner - XL Screw Corporation*

fastener importers in the country. Norman later sold H&T in 1963 to a conglomerate and started another company about the same time the Beatles became popular. Norman named his new company Strum and Drum, Inc., an importer of all types of musical instruments. Stronghold Screw went out of business in 1966.

1968 was a very memorable time in history around the world. Protests were going on in the streets across America as the war in Vietnam raged on. The Beatles song "Hey Jude" finished its 9th week at #1 on the charts. The Beatles released their new album "The Beatles" which would go platinum 19 times. In 1968, the first manned spacecraft reached the moon and safely returned, gas was 34 cents a gallon and the internet wasn't even invented. The world was definitely changing and those with a vision kept doing what they do best.

I have been working at XL since 1972. A few months after I joined XL, Norman perished in a plane crash. Despite the typical obstacles that face a young company and also after just experiencing such a significant loss, Ron Sackheim and I, along with the rest of the XL team, worked hard to keep XL in business. Ron became President after the passing of his father. In 1979, I became Vice President and Ron offered me the opportunity to buy some shares in XL.

In 2002, I became President. Owning 100% of XL was a long time goal and it finally became a reality in 2005.



Doing business and finding suppliers all over the world in 1968 was nothing like it is today. In the early years we had to communicate with overseas suppliers by using teletype machines, phone service was unreliable, traveling the world on long flights with multiple stops on smoke filled airplanes...and in spite of these and many other obstacles and challenges, XL was established and began to flourish with a new concept in mind. Besides the standard fasteners being imported at that time, we were going to do something that other fastener importers had no interest in developing. XL was going to try and keep ahead of the competition by bringing in more sophisticated items and be innovative in areas besides product line. For example, our first shipment from overseas in 1969 was packaged in quarter cartons. We were the first to package in quarter cartons...way ahead of the industry. We always tried to be innovative in our approach...new products, stock and release orders, the mill order concept, we developed material certifications many years before the U.S. Fastener Quality Act required it, outstanding customer service, excellent quality...I could go on and on. Those in the industry know. If we had imitated the other big importers/master distributors thru the years, XL would probably not exist today. Many of the countless importers/master distributors that tried to do it their way spent their powder and they are no longer in existence. XL has survived the times and we are now stronger than ever. We did and still do it our way!

continued on page 18



How things have changed!!



XL SCREW CORPORATION

The distribution market in the fastener industry is continuously evolving. Since the 1950's and at some level probably before, distributors have always had a difficult time meeting their customer's requirements by only buying thru domestic based manufacturing. U.S. based domestic manufacturers primarily focus on large volume production for the OEM market. That is where the import/master distributor has been such a valuable source of supply to our distributor customers and that's how and why we came to be. It is our job to be a main source of supply to our customers. We are a major contributor to the success of the U.S. economy. Domestic manufacturing alone does not and will not satisfy the needs and demands of the distribution market. To provide the best service and quality at a competitive price, XL sources our products from manufacturers all over the world. This is our expertise. We have imported product from Argentina, Brazil, China, Germany, Great Britain, Hong Kong, India, Italy, Israel, Japan, Korea, Malaysia, Mexico, Taiwan, Vietnam as well as buying from U.S. domestic manufacturers. We are forever searching the world for the best quality product that we can sell in our competitive market.

Besides having 3 major distribution centers in Lincolnshire, IL, Strongsville, OH and Austell, GA, XL has always had an office staffed with our own employees and engineers (not agents) in Asia since 1968. Our Asia office was located in Nagoya, Japan for approximately the first 20 years. Eddie Wakayama was our Far East General Manager. Due to the major trade route being moved from Japan to Taiwan, XL then moved our Asia based office to Kaohsiung, Taiwan (XLA), where it remains an integral part of our company today. Luck Tseng has been our Director of Far East Operations from the first day we moved the office to Taiwan. XLA has an amazing staff under the leadership of Luck Tseng. Our Far East operation is a valuable asset to both XL and our customers. Their primary responsibilities are to find new sources of supply, communicate with our suppliers, make sure that our orders are shipped on time and per government regulations and that the integrity of the product's quality and the packaging of the product is not compromised in any way. XL would not be who we are today without

our Far East staff.

Any company is only as good as the people who make it all happen. I am proud to say that our family history in the fastener business now covers 4 generations. BJ Sackheim (Stronghold Screw), Norman Sackheim, Ron Sackheim and myself (Ron and I are second cousins) and now my 2 daughters Amy Sachs Etten (since 2002) and Corrie Sachs Delevitt (since 2012). Both Corrie and Amy are major contributors to our success. Here's hoping for a 5th generation!

We currently have a wonderful staff with hundreds of years of experience in the Fastener Industry. Amazing in this day and age. Wayne Wishnew, (*Vice President*), Bobby Fail (*National Branch Manager*), Kelly Grindle (*Cleveland Branch Manager*), Tom Bigott (*Purchasing Manager*) and Sue Rock (*Director of Network and Admin Services*) are the core of our leadership team. I also want to be sure to mention our terrific warehouse management team and all of our other employees too numerous to mention. Everybody plays a vital role in our success story.

I am proud to say that our management team has been influential in a leadership role in the International Fastener Industry. Ron and Wayne have both been President and on the board of the Midwest Fastener Association. Norman and Ron Sackheim both have been inducted into the Fastener Hall of Fame. And I am humbled to say that I too will be inducted into the Fastener Hall of Fame on October 31, 2018 in Las Vegas. This is an honor I am happy to share with all of the XL employees, past and present.

XL is a major contributor to the distribution market. We take pride in our statement "America's Finest Quality Imported Threaded Fasteners Since 1968." XL has earned the reputation throughout the world as a company you can always count on. "When quality is so consistent, it creates reputation. That reputation is called trust. Trust is the foundation of service. And it is the highest compliment that can ever be paid."



continued on page 20





The Business Edge

Simple · Focused · Effective

The simple solution with a proven step-by-step method for unlocking your fastener company's potential.

Visit our booth in Vegas and let us demonstrate how The Business Edge™ can streamline your business and save you time, effort and money.

**INTERNATIONAL
FASTENER EXPO
BOOTH #2917**



Computer Insights Inc · 108 Third Street, Bloomingdale, IL 60108 · 800.539.1233 · sales@ci-inc.com · www.ci-inc.com





Our reputation is respected by all of our business associates both domestically and internationally. XL has been using “K” Line for over 3 decades to transport XL’s cargo from the Far East. In July, 2005, Fran (my wife) and I were given the rare honor to go to the shipyard of Hyundai Heavy Industries Ltd in South Korea to participate in the Naming Ceremony and be the Godparents of “K” Line’s newest vessel... the M.V. Vecchio Bridge. This extremely high honor was bestowed upon XL because of our professionalism, honesty, integrity and loyalty. This honor reflected “K” Line’s respect for XL and is only given to a select few. As Godmother, Fran was given the honor to christen the ship. A once in

a lifetime experience.

XL will be celebrating 50 years in business this November, 2018. XL has always and will continue to do what we do best. Many importers/master distributors have come and gone. They have tried to be who they are not.

The seeds for XL were planted over 80 years ago. Our roots in the Fastener Industry are deep and strong. The past has been written... new chapters are yet untold.

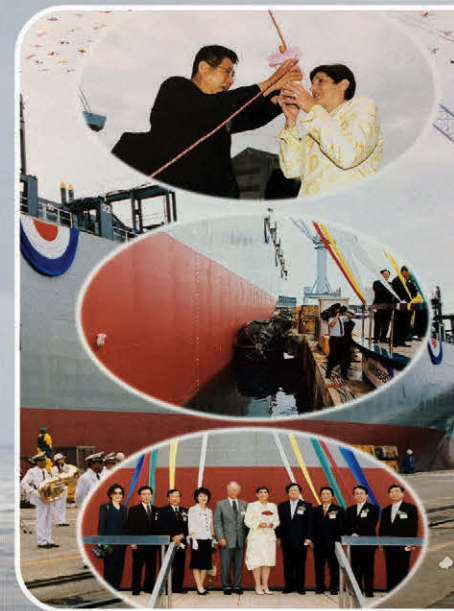

‘Vecchio Bridge’ Naming Ceremony

XL ASIA OFFICE - THE XL GLOBAL ADVANTAGE

XL’s office in Taiwan (XLA) was opened in 1988. XL was the first major fastener importer to open up an office in Taiwan that was staffed with our own employees. XLA is managed by Luck Tseng, Director of Far East Operations. Luck leads our team of quality control inspectors and a full support staff that manages the day to day operations, product inspections, supplier audits, FQA certificate verifications, securing quotes, logistics planning for all of our Far East shipments and Taiwan container loading supervision. The XLA team has many years of experience with government required documentation, shipment consolidations, engineering and quality assurance.

Having XLA on the ground in real time is vital to daily communications with all of our suppliers in the Far East. XLA can instantly assist suppliers and answer questions related to product specifications, document preparation, handle any potential issues prior to shipments and many more tasks. XLA’s QC staff are in the field

each day visiting factories and inspecting products. XL’s products are thoroughly checked to make sure all shipments conform to all proper standards. In addition to factory inspections, the XLA QC Team is on site each week at the container loading terminal supervising and inspecting each and every pallet as it is loaded into the containers. XLA’s strict inspection ensures that all pallets shipped to XL are properly secured, strapped and blocked/braced to withstand the long ocean voyage, rail and truck movements to our warehouses.

Not only does the XLA QC Team perform inspections in Taiwan, they also travel to other countries in the Far East on a regular basis performing factory audits, inspections and qualifying new sources. The XL USA purchasing team also travels to the Far East several times a year searching for new sources of supply, as well as strengthening the relationships with existing suppliers.

more on page 22



IT DOESN'T JUST SET RIVETS, IT SETS

THE NEW STANDARD



Installs:
Blind Rivets
Rivet Nuts
Lockbolts

Say hello to the amazing RivetKing FreeSet™ Series. Fully loaded with industry breakthroughs, so you can free your customers from air hoses, cables, and improperly set rivets. The FreeSet™ is the first of its kind to combine cordless riveting with process intelligence, barcode scanning and Wi-Fi connectivity.

It's not just new technology, it's the new standard by which everything else is measured.

Call Today
For a Free
Demonstration
1-800-BUY-RIVET

**Industrial
Rivet &
Fastener Co.**



INNOVATING FOR THE FUTURE

XL currently stocks over 13,000 inch and metric products in all three U.S. locations. We are constantly adding new items to our extensive line. If you need specials per print or volume commodity products, our Mill Department is well known for our quality, reliability and flexibility to meet our customer's mill requirements.

Our Lincolnshire, IL, Strongsville, OH, and Austell, GA locations are all newly designed state of the art warehouses. XL has designed each warehouse with very strict and detailed specifications which allows for maximum storage capacity and efficiency. All XL warehouses reflect who we are and how we run our business. They are one of our most effective sales tools. Visitors from all over the world are in awe of the cleanliness, efficiency and organization. As they tour our warehouses, they tell us that if we can keep our warehouses in such good condition, they are confident that we will take the same detailed care of their business as well.

Since 1982, we have designed and developed our own unique computer programs. Our proprietary computer programs provides our staff with all of the vital information we need to run our business accurately and efficiently. Our custom computer programs give us the ability to be who we are. Most companies buy generic computer program packages for their business. They become who they are not meant to be because their programs define the way they run their business. XL didn't want to fall into that trap, so we took the time to do it right... for us and our customers.

Our philosophy of excellence in quality and customer service, combined with honesty, hard work and dedication has defined who we are for 50 years. XL has earned the reputation as one of the most trusted names in our industry.

THANK YOU TO ALL FOR OUR FIRST 50 YEARS. WE LOOK FORWARD TO OUR PROSPEROUS FUTURE TOGETHER. 

See our ad on page 132



XL SCREW CORPORATION

**CORPORATE HEADQUARTERS
LINCOLNSHIRE, ILLINOIS**

1-800-323-7367

ATLANTA

1-800-357-3510

CLEVELAND

1-800-338-8668



**VISIT OUR
NEWLY UPDATED
WEBSITE AT**

WWW.XLSCREW.COM

ALFA TOOLS®

CUTTING TOOLS | FASTENER DRIVE TOOLS | ABRASIVES



OUR TOOLS MAKE FASTENING HAPPEN



» Industrial Quality
» Domestic Production

» Inch and Metric Sizes
» Technical Support

» Morton Grove, IL
» 8 Locations Nationwide

INTERNATIONAL
FASTENER EXPO
BOOTH #3410



MEGACUT
Abrasive Wheels & Circular Saws



National Abrasives

ScrewTech



Monolock
QUICK CHANGE SYSTEM

800-253-2532

WWW.ALFACTOOLS.COM



Carmen Vertullo

Carmen is the founder of CarVer Consulting, a San Diego-based consulting, engineering and training company specializing in fasteners and bolted joints. He has experience in fastener quality assurance, manufacturing, sales, and inventory management programs. Carmen is a designer and producer of aircraft support equipment and tooling for all branches of the U.S. military, prime contractors and foreign military sales. He has developed and teaches a series of advanced fastener training classes for the Fastener Training Institute®. Mr. Vertullo is a Certified Fastener Specialist through FTI, and he holds a BS in Manufacturing Engineering Technology.

WHAT FASTENER SUPPLIERS NEED TO KNOW ABOUT CALIFORNIA'S PROPOSITION 65

By the time you read this the new revision to California's Proposition 65, formally known as the Safe Drinking Water and Toxic Enforcement Act, will have taken effect. Prop 65 was enacted in 1986. It was changed a few years ago and those changes took effect after August 30, 2018.

Prop 65 is intended to help Californians make informed decisions about protecting themselves from certain chemicals known to cause cancer, birth defects, or other reproductive harm. It also prohibits the discharge of those chemicals into sources of drinking water.

The State of California has an amazingly complete and well-constructed Prop 65 web site which is administered by California's Office of Environmental Health Hazard Assessment or OEHHA. (<https://oehha.ca.gov/proposition-65>). Beware, that while the web site provides an abundance of information including a Q&A feature, it does not answer some of the most important questions about Prop 65 for either the supplier or the consumer.

Nevertheless, fastener suppliers are encouraged to explore the website thoroughly as they consider this issue. There are hundreds of documents from this and other sources that may be of help to you as well.

The basic requirement for businesses and other entities that expose Californians to these chemicals is that they inform those exposed with labels, signs and notices. The format and content of these labels, signs and notices is very specific. For fastener suppliers, the concern is to not expose Californians to the chemicals

through the use of their product, and to warn them if they do. Fastener suppliers are not concerned with the safe drinking water part of the law. Although it is a California statute, fastener suppliers, manufacturers and importers throughout the country should be concerned if their products are sold in California. Even if you do not intentionally sell your products in California, your company can still become the target of Prop 65 enforcement action.

The chemicals of concern are on a list, called the "Proposition 65 List of Chemicals" that is maintained by California's OEHHA - Office of Environmental Health Hazard Assessment. The list, now 30 years in the making has about 900 chemicals on it. Only a few are of concern to most fastener suppliers who supply fasteners made of metal. The chemicals of concern are: nickel, lead, hexavalent chromium, and cadmium. If this short list sounds familiar it's because it's the same list we see with EU RoHS, REACH, WEE and ELV regulations.

There is a second list, called the "safe harbor list." This list quantifies the safe exposure levels under which no warning is needed according to OEHHA. Safe harbor levels include No Significant Risk Levels (NSRLs) for cancer-causing chemicals and Maximum Allowable Dose Levels (MADLs) for chemicals causing reproductive toxicity. The safe harbor list has about 150 chemicals and all four of our metals are on it. However, the "safe exposure" levels are greatly exaggerated beyond actual known safe exposure levels. Keep in mind – it does not matter if your product has the chemicals or not.

World Class Here at Home!

- ✓ HIGH QUALITY
- ✓ ISO 9002 CERTIFIED
- ✓ AGGRESSIVELY PRICED
- ✓ RAPID DELIVERY
- ✓ BEST OF ALL –
MADE IN THE U.S.A.



Proudly manufactured
in the U.S.A.

IF you've ever experienced problems with overseas sources or ISO compliance, you're not alone. We've all heard the horror stories that could have been avoided by ordering from a quality conscious, certified American manufacturer like Alpha Grainger Manufacturing.

You won't find a commitment to quality and customer satisfaction like Alpha Grainger's elsewhere on the planet. Achieving this level of satisfaction has not been simple. We have designed our own customized computer software and machine tools to create a one-of-a-kind, world-class manufacturing facility here in Massachusetts.

Long recognized as a leading producer of customized fasteners and hardware, Alpha Grainger Manufacturing also stocks a wide array of standard parts that are ready to ship and priced competitively.

Why search the world? Since 1973, Alpha Grainger has been providing the fastener industry with what it needs – consistently superior quality and competitive pricing.

[508] 520-4005
Fax: (508) 520-4185 • www.agmi.com

Captive Panel Screws



Connector Hardware



Shoulder and Thumb Screws



Standoffs



**ALPHA
GRAINGER**
MANUFACTURING, INC.



Richard Hagan

Richard P. Hagan is the president of Pinnacle Capital Corporation, a boutique investment banking firm which specializes in providing merger and acquisition advisory services to the global fastener industry. Hagan has more than twenty-five years of international investment banking experience and has worked on successful domestic and cross-border M&A transactions, corporate restructurings and capital raisings. Hagan earned a B.A. in Economics from the University of North Carolina at Chapel Hill and an M.B.A. in Finance from Fordham University in New York City.
Contact: Phone: 212-267-8200 or Email: rphagan@pinnaclecapitalcorp.com.

FASTENER COMPANY ACQUISITIONS COMPLETED DURING THE FIRST HALF OF 2018

In this issue, we will briefly review all the fastener company acquisitions - a total of 30 worldwide - completed during the first six months of 2018. It is impossible to track every single fastener company transaction because many deals involving private companies are not publicly disclosed. That said, we believe the following list is the most comprehensive and detailed you will find.



On January 4, 2018, **Tenex Capital Management L.P.** ("Tenex") purchased Automotive Vehicle Company, doing business as **Auveco Products**. Founded in 1916 and located in Cold Spring, Kentucky (near Louisville), Auveco Products distributes a broad range of fastener products to the auto body repair shop aftermarket and to the general industrial MRO market. A privately-owned company, Auveco Products sells through a network of master distributors who subsequently service hundreds of thousands of collision centers, repair shops, dealerships and general industrial manufacturers throughout North America. The Auveco Products master catalog is considered the encyclopedia of the auto body hardware industry and contains more than 20,000 SKUs and more than 800 pages. The catalog is available in print and online. Auveco Products offers customers more than 500 pre-packaged assortments (in plastic compartment boxes), along with metal storage cabinets. The company also provides retail displays, unit packaging and bulk packaging (in both bags and boxes). Auveco Products is a new platform investment for Tenex, a New York City-based private equity firm with more than \$800 million of committed capital under management.
Purchase price: not available



On January 5, 2018, **Threaded Fasteners Inc.** purchased **Bolt & Nut Inc.** Founded in 1977 and located in Tampa, Florida, Bolt & Nut is a manufacturer and distributor of fasteners for construction and general industrial applications. Bolt & Nut operates from a 50,000 square foot manufacturing and warehouse facility and employs 21 people. Founded in 1979 and headquartered in Crichton, Alabama (outside Mobile), Threaded Fasteners is a manufacturer and

distributor of steel fasteners for electric utility tower, highway structure, metal building, chemical processing, commercial marine and general industrial applications. An employee-owned company since 2012, Threaded Fasteners operates seven branches located in: Semmes, Alabama; Pensacola, Florida; Panama City, Florida; Tampa, Florida; Gulfport, Mississippi; Chattanooga, Tennessee; and Tulsa, Oklahoma. The company has an aggregate of more than 232,000 square feet of manufacturing and warehouse space and employs more than 160 people. Following the transaction closing, the Tampa branch of Threaded Fasteners was consolidated into the nearby Bolt & Nut facility.

Purchase price: not available



On January 12, 2018, **Fairmont Supply Company** ("Fairmont") purchased **THB Inc.** Founded in 1986 and headquartered in Salt Lake City, Utah, THB is a distributor of production fasteners supplying a diverse customer base including automotive, high pressure valves, fitness equipment and medical devices. In addition to a full line of fastener products, THB provides customers with customized packaging, kitting and light assembly services. The company offers more than 100,000 SKUs and maintains a branch warehouse in Boise, Idaho. Founded in 1921 and headquartered in Washington, Pennsylvania, Fairmont is a full-line distributor of industrial MRO supplies serving customers across the United States. Fairmont is ranked number 49 on Industrial Distribution's Big 50 List of industrial suppliers. The company operates 17 distribution centers, along with on-site store locations serving more than 5,000 active customer accounts. The company offers more than 200,000 SKUs and differentiates itself by serving as a one-stop shop for customers' industrial MRO requirements and creating tailored programs for customers' needs. Following the transaction closing, THB expanded its product offering to include a full-line of industrial MRO supplies. Fairmont is a portfolio company of **Tenex Capital Management L.P.**, a New York City-based private equity firm with \$800 million under management.
Purchase price: not available

**INTERNATIONAL
FASTENER EXPO
BOOTH #3010**



**Century
Fasteners
Corp.**

quality parts for aerospace



service · inventory · integrity

PRODUCTS IN STOCK FROM WORLD CLASS AEROSPACE MANUFACTURERS

AIR INDUSTRIES ▪ ALCOA ▪ BRISTOL ▪ CALFAX ▪ CHERRY AEROSPACE ▪ FAIRCHILD ▪ HI-SHEAR ▪ KATO ▪ KAYNAR ▪ LISI AEROSPACE
MONADNOCK ▪ MONOGRAM AEROSPACE ▪ PB FASTENERS ▪ REPUBLIC FASTENERS ▪ ROSAN ▪ SHUR-LOK ▪ SPS AEROSPACE ▪ TRIDAIR

BOEING, AIRBUS & LOCKHEED BAC ▪ LS ▪ ASNA ▪ DAN ▪ EN ▪ NSA ▪ 3M ▪ 3D ▪ ST3M



CENTURY FASTENERS
CORP.



CENTURY FASTENERS
DE MEXICO

AUTHORIZED DISTRIBUTOR FOR  **CHERRY[®]
AEROSPACE**

Contact our Distributor Sales Team at 1-855-332-4445 or email aerospaceparts@centuryfasteners.com



www.centuryfasteners.com



INDUSTRIAL FASTENERS INSTITUTE

636 Oak Tree Blvd., Independence, OH 44131

TEL 216-241-1482

FAX 216-241-5901

EMAIL info@indfast.org

WEB www.indfast.org

INDUSTRIAL FASTENERS INSTITUTE NAMES DAN WALKER AS MANAGING DIRECTOR

The Industrial Fasteners Institute (IFI) is pleased to announce the appointment of Dan Walker, P.E. as the institute's Managing Director. The IFI Board of Directors announced the selection following a comprehensive search for a leader who understands the invaluable contributions the fastener industry makes to the North American economy, and who can provide strategic direction, motivation and new energy to the mission of IFI.

Walker comes from the Metal Building Manufacturers Association (MBMA), where he served in a number of technical roles over the years prior to being named the group's General Manager. Dan has over 20 years of trade association management experience, having also served as the Executive Director of the Concrete and Masonry Anchor Manufacturers Association (CAMA). Walker earned his Bachelor of Science degree in Civil Engineering from Cleveland State University, and he is a licensed Professional Engineer in the State of Ohio. His considerable association management experience will prove invaluable to IFI as they continue to grow and work on new initiatives set forth in their strategic plan for the benefit of the North American fastener industry.

When asked about this opportunity, Walker said "I am truly honored to have been selected as IFI's next Managing Director. As an organization, IFI has a proud history of technical leadership and education that is second to none. Our members and highly qualified staff have achieved a great deal toward ensuring a healthy and vibrant fastener industry through their research, standards, advocacy and education programs. The

member leadership has set clear goals for the sustained growth of the institute, and I'm very excited to start helping them achieve those goals."

The selection of Walker comes after the outgoing IFI Managing Director, Rob Harris, announced his planned retirement. "Last year, when I announced my intention to retire, it was important to me and the Board of Directors

that we find a worthy and capable leader, and that we ensure a smooth transition so that IFI could continue its important work without missing a beat," said Harris, who successfully led the organization for more than 22 years. "I've had the chance to work with Dan during this transition, and I know we have the right person for the job. I feel very confident that I am leaving this great organization in good hands."

IFI Chairman, Phil Johnson, was part of the Executive Search team that recruited Walker. He said, "Our search team wanted an experienced association professional with a demonstrated track record of creating growth, enthusiasm, and executing on strategic initiatives. I have no doubt that Dan's experience makes him the right person to take on this important role, and I'm very excited to have him leading the team."



About IFI

Industrial Fasteners Institute is a trade association of leading North American fastener manufacturers and suppliers of materials, machinery, equipment and/or engineered services. Founded in 1931, IFI members combine their resources to seek solutions that advance fastener application engineering. 

FALL RIVER

Fall River Manufacturing Co., Inc.

YOUR DOMESTIC SOURCE FOR STAINLESS STEEL AND NON-FERROUS SCREWS, BOLTS & NUTS

NEW INCREASED SIZE RANGES

UP TO 3/4 X 8 IN STAINLESS STEEL - 302HQ (18-8), 304L, 316L, A286
UP TO 7/8 X 8 IN NON-FERROUS - SILICON BRONZE, BRASS, ALUMINUM, NiCu400

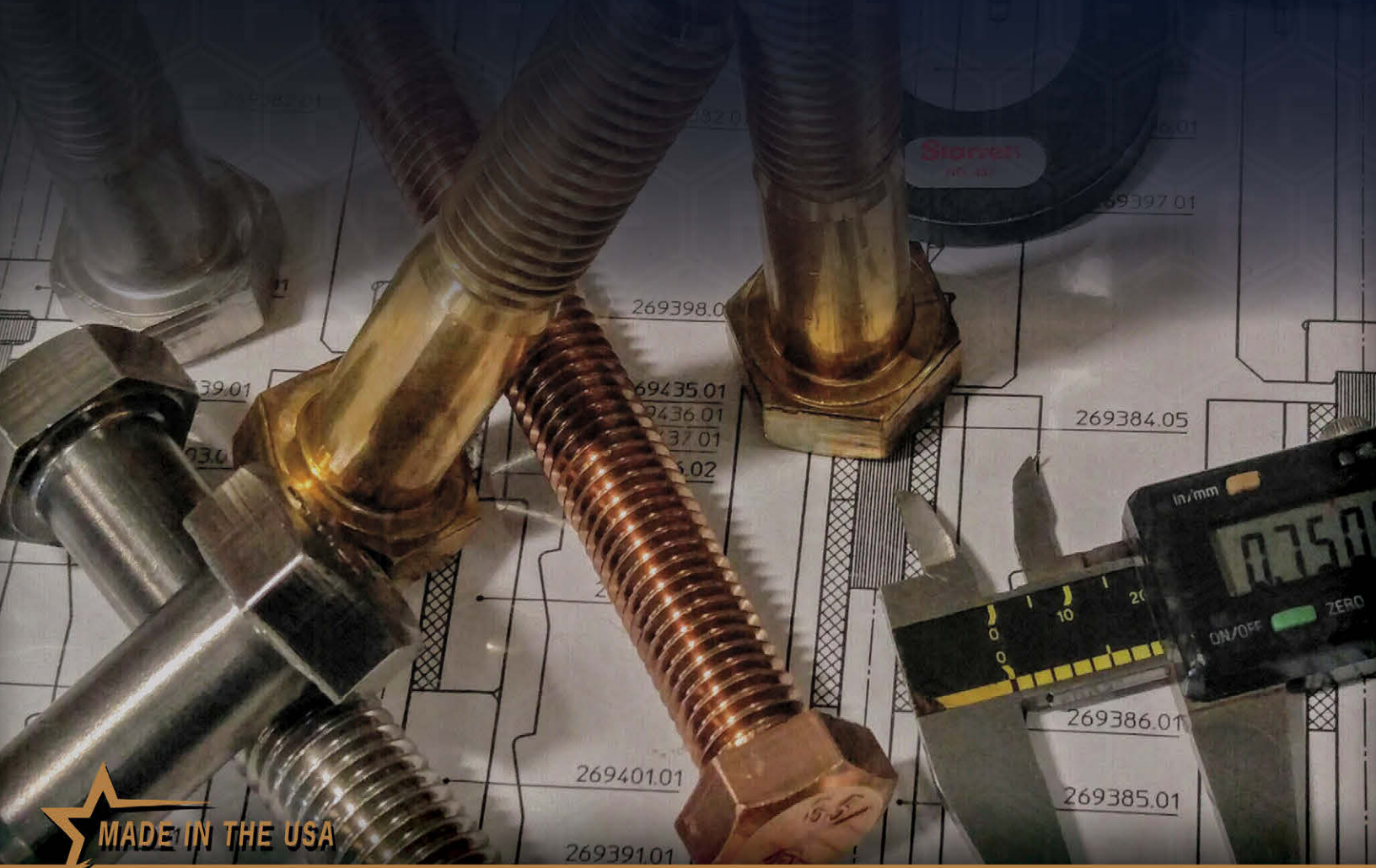

MADE IN THE USA

TEL 1-800-275-6991 FAX 508-675-8770  www.fallrivermfg.com

FASTENER FAIR USA

Mack Brooks Exhibitions Inc, 11 E. Adams Street, Suite 200 | Chicago, IL 60603 | USA
 TOLL-FREE 866-899-4728 EMAIL fastenerfairusa@mackbrooks.com WEB www.fastenerfair.com/usa

EXHIBITORS COMMITTING EARLY TO SHOWCASE SOLUTIONS AT FASTENER FAIR USA 2019 by Lauren Oscarson



AMERICA'S EXHIBITION FOR
THE FASTENER AND FIXING INDUSTRY

COBO CENTER, DETROIT, MICHIGAN USA
MAY 22-23, 2019

Several prominent industry leaders in the fastener market have committed early to exhibit at Fastener Fair USA, the leading fastener and fixing exhibition in the U.S. for the full supply chain. Exhibit sales are showing strong growth for the show with 54% of the exhibit space reserved to date. Companies like Intools Incorporated, Carlo Salvi USA, Brighton Best, Dorken MKS-System GmbH & Co. KG, Atotech, AVK Industrial Products, Unbrako LLC, and Loomis International will be showcasing their fastener and fixing products and solutions at the show to be held at the Cobo Center in Detroit, MI May 22-23, 2019.

"Before we even left Cleveland, we had nearly 30% of 2018 exhibitors rebooked for Detroit," said Jessica Boweak, Exhibition Manager for Fastener Fair USA. "Repeat exhibitors are increasing space requests and we've attracted several new companies, as well. We are already tracking ahead compared to last year and are set to exceed 2018 both in square footage and number of exhibiting companies."

But, exhibitors aren't the only ones signing up early for Fastener Fair USA 2019. A strong number of association partners and sponsors have committed already as well. In fact, Fastener Training Institute, the Industrial Fasteners Institute, the National Fastener Distributors Association (NFDA), the Pacific West Fastener Association, and Women in the Fastener Industry (WIFI) are all returning as association partners in 2019.

In addition, Aluminum Fastener, Alloy and Stainless Fasteners, and Ken Forging have already committed to sponsor the 2019 show.

Several industry publications, including Link Magazine, have signed on as media partners again for 2019.

"Sponsors and association partnerships were key to our success last year," said Melissa Magestro, Executive Vice President of Mack Brooks Exhibitions, Inc., the exhibition's organizer. "We are very pleased to have some of the fastener industry's leading companies and associations back supporting us again."

What's New?

Building on the positive feedback of the show in Cleveland, show management is adding new tactics to enhance the experience and increase the value of the show to exhibitors and attendees, such as more educational sessions, a new Bonding and Adhesives area, and a new location.

Mack Brooks Exhibitions, the worldwide organizers of Fastener Fair, intended for the show to offer a unique opportunity to get the latest industry information, forecasts, and technical education for all levels of experience, industry focus, and visitor segments.

"We heard that the educational sessions offered unique value not seen at other fastener events, so we want to build on that even more," said Boweak. "We are going to increase the number of sessions and have two stages for educational workshops in 2019."

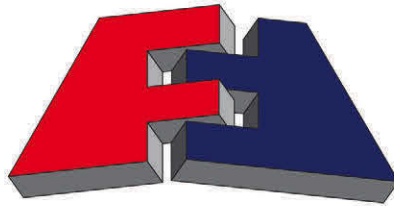

FASTENER FAIR
USA

MAY 22-23, 2019, COBO CENTER, DETROIT, MICHIGAN

JOIN US AT
FASTENER FAIR USA 2019!

Contact us today to learn more
about the next show, reserve
a booth, and much more!

www.fastenerfair.com/usa

FOR **ALL** THE INDUSTRY,
IN THE **HEART** OF THE INDUSTRY

Organized by:

MACKBROOKS
exhibitions

SOLUTION INDUSTRIES

ev·o·lu·tion

the gradual development of something from a simple to a more complex form

From our humble beginning in ZINC to...
A FULL SERVICE VMI SUPPORT MACHINE
 Mill Shipment Marvel • 'Specials' Savior
 Socket Special Superhero

the original secondary process master distributor

☎ 1-866-297-8656 ✉ sales@solutionind.com 🌐 www.solutionind.com

SOLUTION INDUSTRIES LLC

17830 Englewood Dr, Unit 11, Middleburg Hts, OH 44130

TEL 1-866-297-8656 FAX 440-816-9501 EMAIL sales@solutionind.com WEB www.solutionind.com



SOLUTION'S SOLUTION

Solution Industries began with a small machine shop and an ad campaign that stated "send us your specials". Years, and many zinc plated socket heads later, Solution has EVOLVED into a company that handles a multitude of specials and secondary operations for other VMI distributors. Solution partners with companies that do plating, coatings and patching to drive out hidden expediting and handling costs that distributors face when they do these secondary operations themselves. The addition of talented personnel with importing experience has enabled Solution to further drive down costs and even become a reliable partner with MILL SHIPMENTS on special, made to print parts. Solution has added new packaging & kitting machines to meet the specific needs of our customers. As we continue to EVOLVE, so does the Fastener Industry. Not only do we continue to listen and

react to the needs of your customers, but we try to be proactive in regards to the issues that arise in the industry – after all, we stand behind our name and continually offer SOLUTIONS. So much so that **we'd like to introduce our newest addition, Milton Mills (M²)**. Milton, known for his quality expertise and solving quality issues, is ready **to help reduce costs while maintaining the same high quality product customers have come to expect.**

We will continue to listen to the Fastener Industry and strive to overcome any obstacles.

Back at the Distributor's Link Magazine...meet our newest **TEAM SOLUTION** addition...ready to help the Fastener Industry thrive...

...flip the foldout on the next page to see our commemorative 1st Edition of Solution's Solution Comic 🗨️



SOLUTION INDUSTRIES

SOLUTION INDUSTRIES

SOLUTION'S SOLUTION



...enter Milton Mills

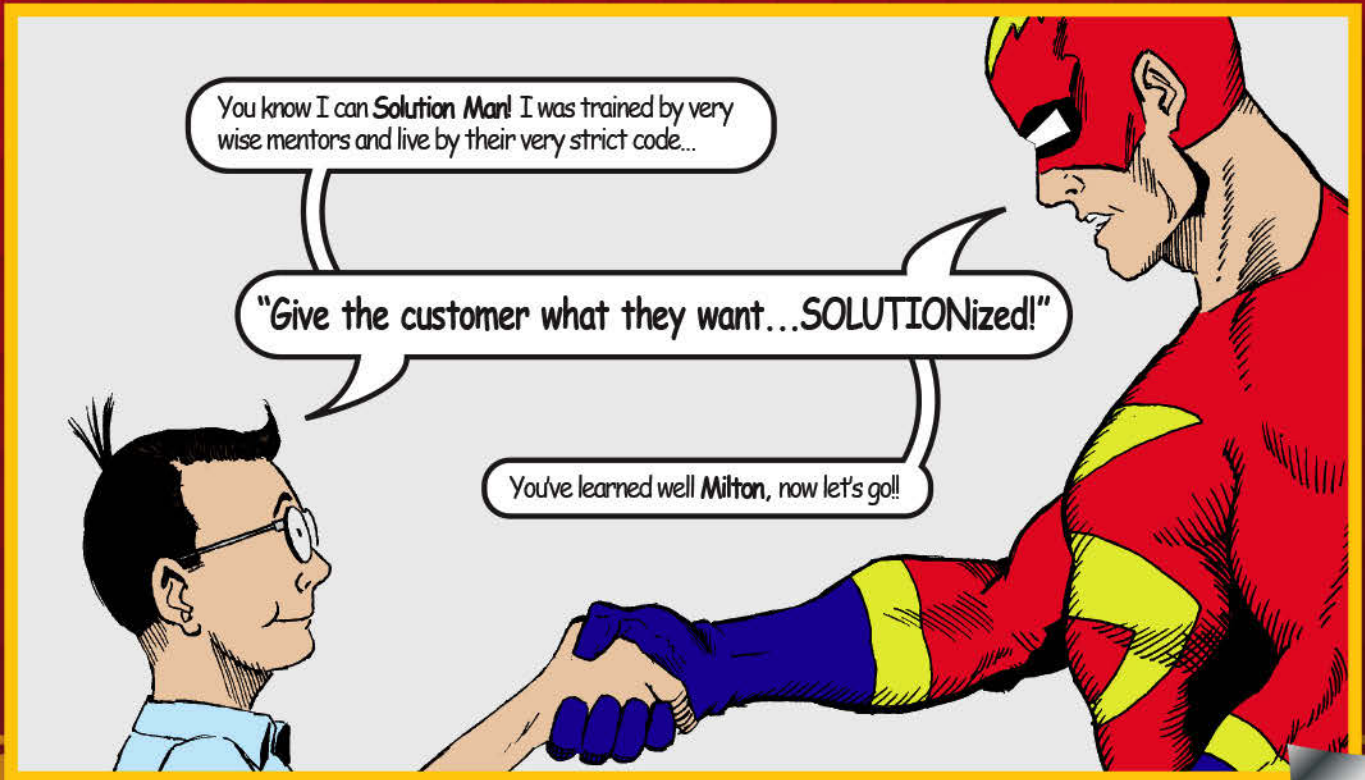

one call, one invoice, one shipment, **one solution.**

FLIP TO NEXT PAGE FOR MORE

...the team gets to work...

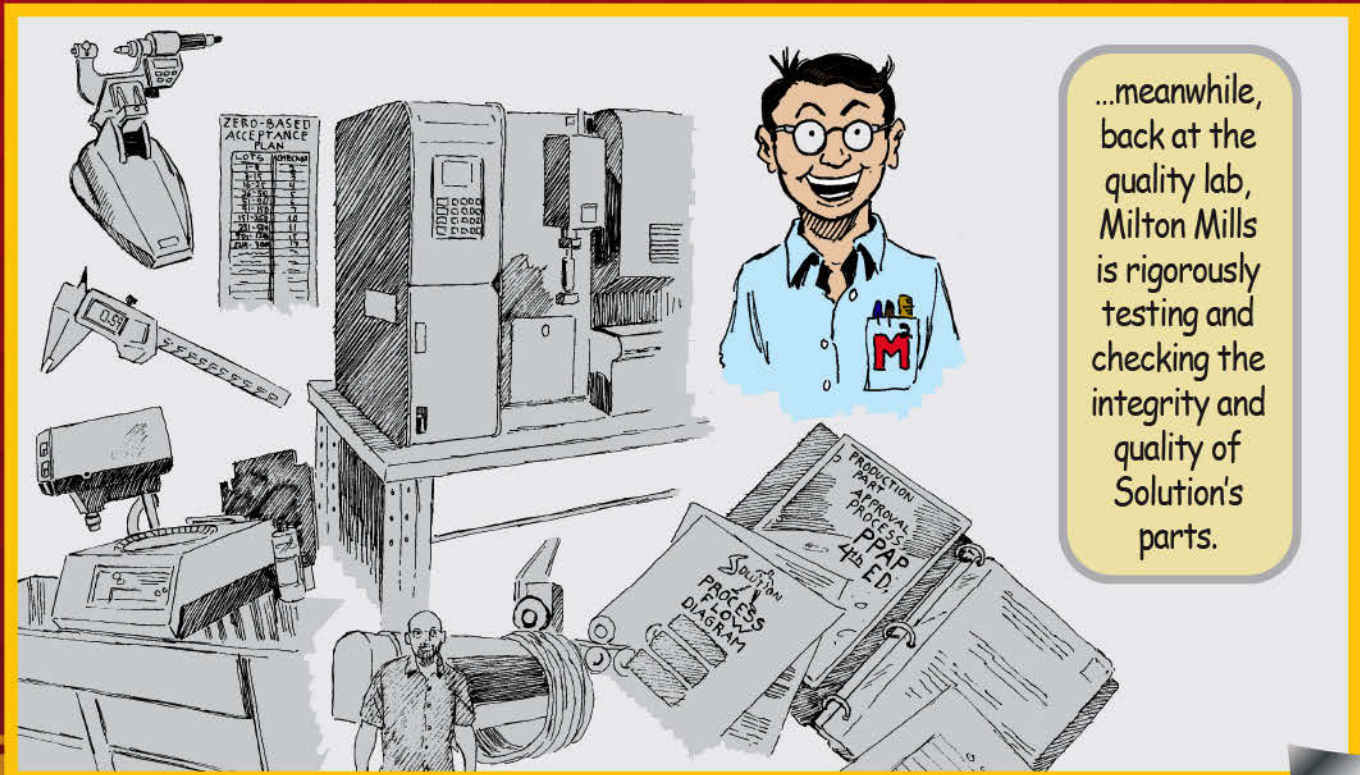

we **are** solution.

FLIP TO NEXT PAGE FOR MORE

...with great results!

Well **Solution Man**, you've done it again. You have delivered special parts, on time, with the proper certification. **Solution Man**, you are the super hero of the Fastener Industry...

Now **Solution Woman**, you know I could not have done it without you, **Milton**, and the rest of the **Solution Team**.

...and **Milton Mills** certainly is a great addition to our team! Great job and way to go **Solution Man!**



we **are** solution.

FLIP TO NEXT PAGE
FOR MORE

The City sleeps easier tonight as Team Solution successfully worked their magic to **HOLD** the city together once again. As the sun rises on a new day, Team Solution is ready to accept any and every challenge that comes their way. Stay tuned for another episode of Solution's solution...

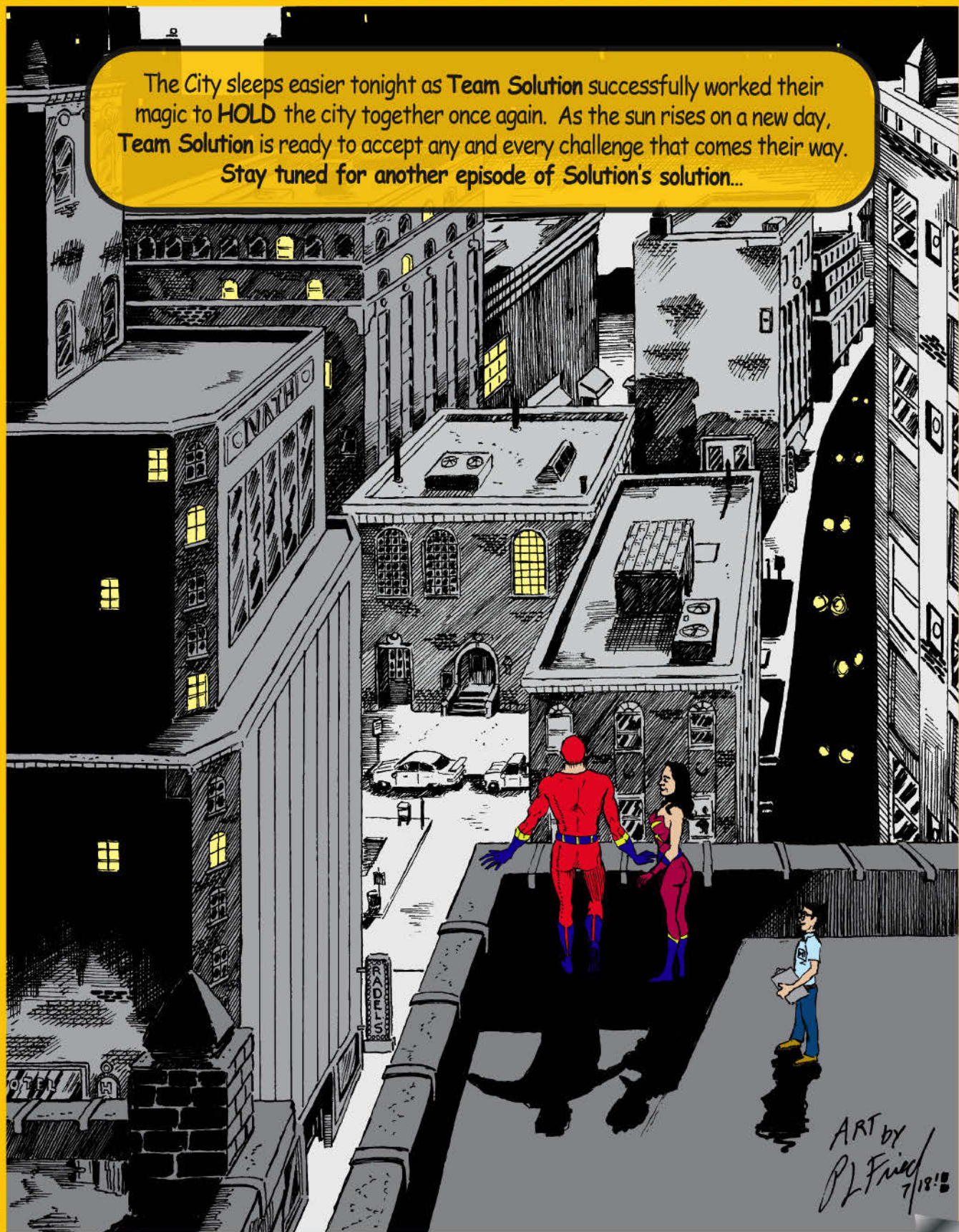

one call, one invoice, one shipment, **one solution.**

FLIP TO NEXT PAGE
FOR MORE



SOLUTION INDUSTRIES

A FULL SERVICE VMI SUPPORT MACHINE



Socket Products – Inch and Metric

Socket Cap | Flat Socket | Button Socket | Shoulder Screws
Socket Set Screws | All Finishes Available



Secondary Process Work

OEM Specific | Special Packaging
Electroplating | Mechanical Plating | Dip Spin



Nylon and Adhesive Patch

Pellet & Thread Locking | Customer Specific



CNC Specials To Print

Short Run | All Exotic Materials



Mill Division

Specials to Print | Short Lead Times
Small Minimums | Dock to Door Service
Stock and Release Programs

Value Added Services

Special Packaging | Kitting
Private Labeling | Bar Coding
Plain Boxes | Polybagging

Quality

Level III PPAP
~ precision testing available ~
ISO 17025 Accredited Lab

INTERNATIONAL
FASTENER EXPO
BOOTH #2717



the **original** secondary process master distributor

☎ 1-866-297-8656

✉ sales@solutionind.com

🌐 www.solutionind.com

WORLD'S LEADING SUPPLIER OF FASTENER INSPECTION EQUIPMENT

GREENSLADE & COMPANY, INC



Odds are you will find
Greenslade & Company a GOOD BET

Visit us at the

International FASTENER EXPO

Oct 30 – Nov 1, 2018

Booth #3235

Mandalay Bay Convention Center
Las Vegas, USA

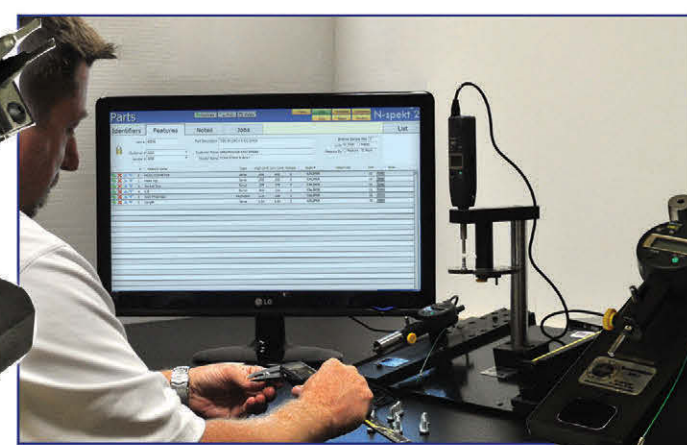
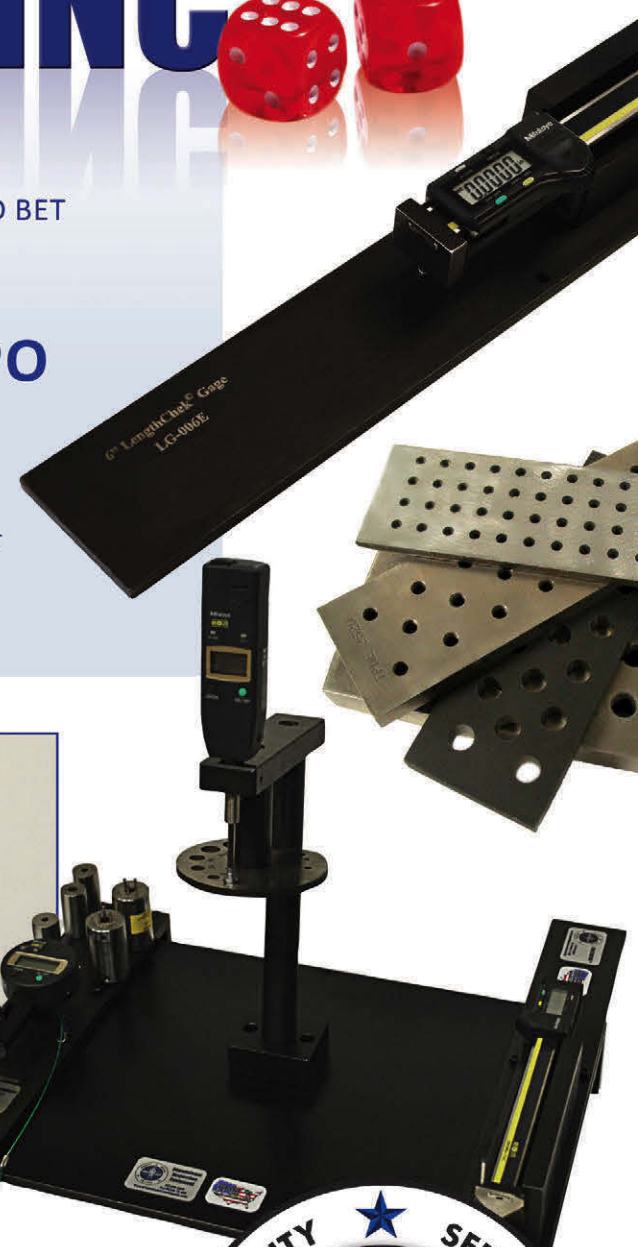

STAY CONNECTED



**Depicted Equipment is not
A2LA accredited. Please consult
A2LA Certificate #1032.01 for a list
of accredited tests.*

GREENSLADE & COMPANY, Inc.
2234 Wenneca Ave, Fort Worth, TX 76102
Phone: 817.870.8888 | Fax: 817.870.9199
sales1@greensladeandcompany.com
www.greensladeandcompany.com

COMPUTER INSIGHTS, INC

108 Third Street, Bloomingdale, IL 60108

TEL 1-800-539-1233

EMAIL sales@ci-inc.com

WEB www.ci-inc.com



HOW GOOD IS YOUR USER SECURITY?

Today almost everyone understands the need to maintain up to date professional security protection software. The news is full of stories about companies that have suffered cyber-attacks of all kinds. Of these, the worst seem to be Ransomware attacks and they are one of the fastest growing forms of cyber-attacks. These are nothing but modernized extortion. With up-to-date protection most of these attacks can be prevented.

Employee Security

There is another pervasive, but less recognized threat, that is going on right inside the companies' walls. The amount of employee misbehavior is hard to measure because it takes so many forms. It can range from petty theft, to information stealing to grand larceny through theft or embezzlement.

Who Can You Trust?

Deciding who to trust is not easy. It usually takes time to gain trust in an employee and the trust has to be earned by a display of honorable behavior. Psychologists are always searching for better ways to determine who can be trusted and who can't.

In a recent experiment on the subject at the University of Chicago, they determined that the most trustworthy people are the ones that are most guilt prone.

Emma Levine, associate professor at the Booth School of Business at the University of Chicago said, "Our research suggests that if you want your employees to be worthy of trust, make sure they feel personally responsible for their behavior and that they expect to

feel guilty about wrongdoing." *Source: Sandra Jones for the University of Chicago*

It's not an easy task.

What Can You Do?

Your ERP system must provide the ability for you to control who sees what and who does what. Without this basic protection, your company is surely at risk. The bigger the company, the more important these controls become. In a small family-owned company, everyone often knows everything and that's ok as long as it is all family. Once you begin bringing in outsiders though, things change.

The Business Edge™

A good place to start is to have a good security system built into your ERP software. In The Business Edge™ we have included an extensive security system that is both comprehensive and easy to administer. The management of the company selects the number of security levels. There are 10 levels available, but they do not all have to be used. More than one department can share the same level, reducing maintenance for the System Administrator.

Level	Description
01	System Administrator
02	Management
03	Credit Department
04	Accounting
05	Purchasing
06	Warehouse
07	Data Processing
08	Sales Department
09	Minimum Access User
10	Quality



FASCOMP ELECTRONIC HARDWARE

1235 Tradeport Drive, Orlando, FL 32824

TEL 407-226-2112

EMAIL sales@fascomp.com

WEB www.fascomp.com

FASCOMP CONTINUES TO EXPAND AND DEVELOP

Fascomp Electronic Hardware was established in 2001, by co-owners Mark Georgia and Jason Bertone. Quickly, the industry dubbed the dynamic duo affectionately as "The Good Guys", because of their honest and trustworthy reputation. Together, Mark and Jason possess over 40 years in the business. Over the past 10 consecutive years Fascomp has continued to make huge strides, seeing over double digits of growth each year and 2018 is no different. Continuing to breed a culture of expansion and development, Fascomp is excited to announce the purchase of their new home base for their Northeast operation. The 20,000 square foot building, located in Naugatuck, Connecticut, will produce unusual configurations for a wide variety of applications outside the standard catalog products.

In June, Fascomp renewed their ISO certification, demonstrating their commitment to excellence. "We're 100% committed to constant analysis and improvement



of every aspect of our business. This distinction (ISO Registration) assures our customers of the consistent, defect free products and the excellent service they require and deserve." Kyle

Georgia, GM, CT location.

Vast improvements have been made to their computer systems which have enhanced all other aspects of their operation. This was done by Fascomp switching over software systems to Inxql. With these improvements in place, and many to come, the future is looking bright at Fascomp. On the horizon expect to see an expanded product offering, and a newly revamped website. The website upgrades being worked on will enable customers to easily build a part, and retrieve the correlating Fascomp part number and blue print.

Fascomp's product line includes spacers, standoffs, handles, jackscrews, thumbscrews, captive screws, shoulder screws and other made-to-print machine products. 

FASCOMP

BUSINESS FOCUS ARTICLE



Supplying the World

Design - Manufacture - Deliver

- Distributor Support • Design Work at the Customer
- World's Largest Inventory • National Sales Force

Fine Quality Electronic Hardware

- Male-Female Standoffs
- Female Standoffs
- Male-Male Standoffs
- Spacers
- Shoulder Screws
- Captive Screws
- Thumbscrews
- Swage Standoffs and Spacers
- Handles and Ferrules
- Jackscrews



Fascomp provides Distributors:

- ✓ Co-op Advertising Dollars
- ✓ Joint Sales Calls with our Reps
- ✓ Product Training for your Staff
- ✓ Aggressive Prices-Huge Inventory
- ✓ A Friendly Supplier you can Trust

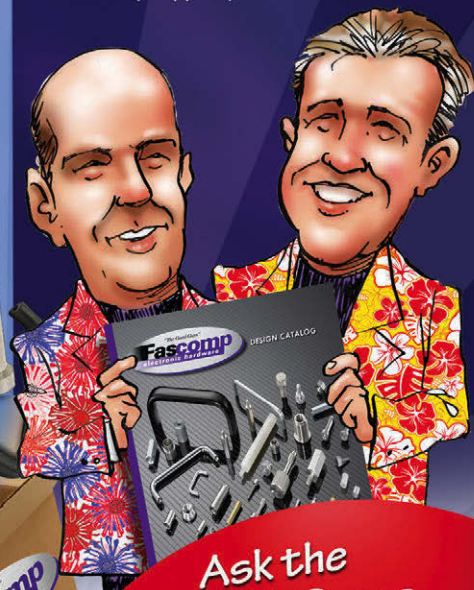

Ask the
Good Guys
for a Catalog Today!

www.fascomp.com

INTERNATIONAL FASTENER EXPO

TEL 323-817-2226 FAX 310-481-1909 EMAIL morgan.wilson@emeraldexpo.com WEB www.fastenershow.com

INTERNATIONAL FASTENER EXPO 2018 SHOW PREVIEW

The 2018 International Fastener Expo (IFE) will take place October 30 – November 1, 2018 at the Mandalay Bay Convention Center in Las Vegas, NV, USA. This year's event is expected to draw over 800 manufacturers and 5,000+ attendees from around the world. It is the largest and most diverse gathering of fastener and industrial professionals in North America and serves all reaches of the supply chain, from manufacturer to distributor to end user.

IFE announces that for the first time, the show will open its exhibit floor a half day early, Tuesday, October 30 from 1:00 – 4:00 pm for Preview Day followed by two full exhibit days on Day 2 and Day 3. Opening half a day early allows extra time for IFE's exhibitors to step away from their booth to network and meet with suppliers within Machinery & Tooling and SourceGlobal without it affecting their business when the show officially opens on Day 2.

On Preview Day, attendee and exhibitors will only have access to the Machinery & Tooling area and SourceGlobal, the show section devoted to international factories. At SourceGlobal, distributors and master distributors of fasteners and other related industry products (machinery, tooling, software, etc.) can explore new suppliers and products for their business. You can find more information about SourceGlobal at www.fastenershow.com.

IFE will once again kick off the show with their annual Welcome Reception, Tuesday, October 30 from 6:00 – 8:00 pm at the Daylight Pool of the Mandalay Bay Resort & Casino. Attendees and exhibitors can mix and

mingle amongst their peers while listening to a live DJ, enjoying light appetizers and two hours' open bar. This is also an excellent networking opportunity for exhibitors and attendees to meet and develop fruitful business relationships before the show.

An event not to be missed is the IFE Awards Ceremony taking place on Wednesday, October 31 from 2:30 – 3:30 pm in the Sessions Corner area on the show floor. Running for 37 years, the "Hall of Fame" award recognizes and honors stand-out professionals who have made significant contributions to the fastener industry. The ceremony will also commemorate the winner of the "Young Fastener Professional" award which is presented to a professional under 40 who has shone through their engagement in advancing the industry.

For three days IFE is offering a comprehensive seminar track of sessions and workshops over the course of the show. There will be a full day of educational sessions on Day 1 and various 30-minute to an hour sessions on the show floor during the rest of the show. A full list of sessions and workshops will be available on IFE's website.

Participating for the first time this year is the European Fastener Distributor Association (EFDA), bringing 19 European distributors and delegates to visit IFE. EFDA represents 170 European-based innovators with collective sales of more than 4 billion Euros.

To register for IFE, visit www.fastenershow.com. For information on exhibiting at this year's event, contact Joseph Woo at +1.323.817.2249 or visit www.fastenershow.com. 



superior quality +

- Fender Washers
- Oval ID Washers
- Oval OD Washers
- Inner Race Spacers
- Bolt and Screw Standard Washers
- Brass Standard Washers
- Fiber Standard Washers
- Metric Standard Washers
- Nylon Standard Washers
- Outer Race Spacers
- Phenolic Standard Washers
- SAE Standard Washers
- Strain Machine-Screw Standard Washers
- Steel Machine-Screw Standard Washers
- Teflon Standard Washers
- USS Standard Washers
- Inside D-Shape Washers
- Inside Double D-Shape Washers
- Outside D-Shape Washers
- Outside Double D-Shape Washers
- Rectangular Washers
- Slotted Round Washers
- Slotted Square Washers
- Square ID Washers
- Square OD Washers
- Tag Washers
- Aluminum Special Flat Washers
- Beryllium Special Flat Washers
- Brass Special Flat Washers
- Celcon Special Flat Washers
- Copper Special Flat Washers
- Delrin Special Flat Washers
- Felt Special Flat Washers
- Fiberglass Special Flat Washers
- Fibre Special Flat Washers
- Inconel Special Flat Washers
- Kapton Special Flat Washers
- Laminated Special Flat Washers
- Lead Special Flat Washers
- Mica Special Flat Washers

superior product +

superior service =



THE SINGLE SOURCE SUPPLIER FOR ALL YOUR WASHER & GASKET NEEDS

NEW YORK Tel: 631-273-8282 Fax: 631-273-8088 | **SOUTH CAROLINA** Tel: 803-366-3250 Fax: 803-366-3511

Email: swg@superiorwasher.com | www.superiorwasher.com





Jim Ruetz

Jim Ruetz is the Chief Executive Officer of AIS-All Integrated Solutions. He lives in Oak Creek, Wisconsin with his wife of 30 years. Jim was born with a cleft palate and understood firsthand the challenges of growing up with a disability. When he heard about CURE DUCHENNE, he decided to take care of two dreams... riding his motorcycle across the world and helping kids - which has always been important to him. "I encourage you to join me in my journey by helping to raise awareness and funds for CURE DUCHENNE," said Ruetz. For more information or to contribute see www.CureDuchenne.org.

AMERICAN FASTENER RIDER TOURS AUSTRALIA FOR DUCHENNE MUSCULAR DYSTROPHY



Dear Fastener Industry Family,

The fastener community has proven time and again to be one of the most generous & philanthropic industries in the world. I think this is driven from the fact that nearly all the companies started as small firms and grew through hard work and a desire to succeed. Fastener industry team members and owners have contributed countless Millions over the decades through numerous trade organizations and individual company donations as their way of giving back. The fastener community has always answered the call.

Over the past four charity rides for Cureduchenne Muscular Dystrophy the fastener community has responded by donating nearly \$30,000 to help find a cure for this crippling disease. I'm making this appeal to the entire community to help us reach our goal and help Cureduchenne find the cure. I'm hoping we

can raise an amount equal to all of the previous rides combined - \$30,000. To accomplish this we'll again need contributions from the longtime supporters who have followed my rides over the years via my blog (mytb.org/jimbmw) but we'll also need new contributors to help us reach this lofty goal. Please consider going to www.cureduchenne.org/Jimsride and make a donation. 100% of the proceeds go directly to cureduchenne and will help find a cure for this crippling disease.

At 61 years old I've got a finite number of long rides left in me -so come on fastener community help make us make our goal and find a cure. 🍀

Thanks,

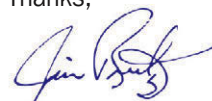
Jim Ruetz

DUCHENNE MUSCULAR DYSTROPHY

1 IN EVERY 3,500
BOYS ARE DIAGNOSED

MOST DON'T SURVIVE THEIR
MID-20s



CureDuchenne is recognized as the global leader in research, patient care and innovation for improving and extending the lives of those with Duchenne muscular dystrophy. Our actions fuel hope for families, enable progress for drug development, and extend ambulation for patients in collaboration with pharmaceutical companies, medical and healthcare professionals, our scientific advisory board, and our board of directors.

Together, we can CureDuchenne!





Lorri Hunt

Lorri Hunt, a U.S. technical expert and co-convenor for ISO 9001:2015. She is the co-author of the upcoming ISO 9001:2015 Handbook, *A Practical Guide to Implementation* published by Paton Profession. She is an Exemplar Global lead auditor, a frequent contributor to quality publications and journals, and a speaker all over the world. She is the president of Lorri Hunt and Associates Inc. and may be contacted at lorri.hunt@gmail.com.

THE ISO 9001 TRANSITION IS OVER, NOW WHAT?

Organizations that are certified to ISO 9001 will have all transitioned to ISO 9001:2015 by September 15, 2018. With this milestone comes a sense of relief. However, it is important that organizations do not rest on their laurels but ensure that the actions that were completed as part of the transition are sustainable. Specifically, attention should be given to the “new” requirements of the standards that focus on the strategic direction of the organization.

Many of the new requirements in ISO 9001:2015 are activities that are traditionally performed in organizations. In some cases, during the transition organizations struggled with understanding their business to the new requirements. The ISO 9001 standard brings a sense of structure to these requirements for larger organizations and provides a roadmap to smaller organizations or organizations that conducted the required analysis for the strategic direction of the organization in an informal manner.

The revised standard incorporates requirements that focus on the strategic direction of the organization. This means that business-related decisions have a direct correlation to ISO 9001:2015 requirements. There are several requirements where consideration of the strategic direction is required. Ensuring these requirements were not just compliant at the time of the

transition audit but have a repeatable approach is key to ongoing success.

Requirements to confirm include the following:

4.1 Context of the Organization – *The standard now requires that organizations determine the external and internal issues that could affect the organization. The requirement also*

requires that the organization monitor and review these requirements. Furthermore, there is a requirement in management review (clause 9.3) that organizations review changes in the external and internal issues.

During the transition, many organizations could discuss this requirement while others did not always truly understand the meaning of the requirement. They may have in a generic sense met the intent of the requirement, but not necessarily the spirit of it. For these organizations, the repeatability of implementation during the surveillance audit may be

difficult to demonstrate.

The external and internal issues are meant to be dynamic and that organizations consider changes in issues that could affect the strategic direction of the organization. With that said, it is not absolute that these issues change every time they are reviewed, but it is possible that there would be needed changes based on changes in industry (e.g. more automation), competition, growth (e.g. new customers or product lines) or political (e.g. tariffs, laws).

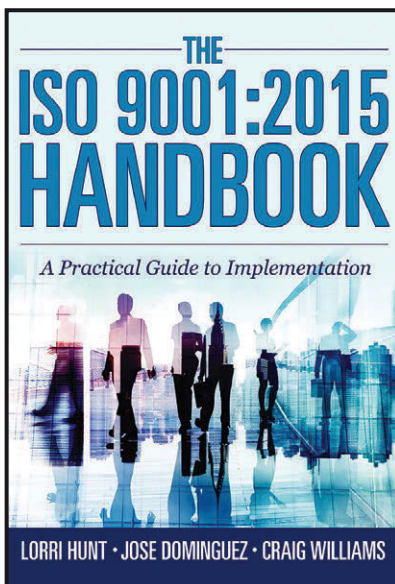

YOUR #1 SOURCE FOR METRIC HEAVY HEX FLANGE BOLTS

ICS FLANGE

THE FLANGE EXPERTS

- AVAILABLE SIZES -
M6 THRU M20
- PER IFI 538 STANDARD
- MANY FINISHES IN STOCK -
ZINC, ZINC YELLOW,
PHOS & OIL & BLACK ZINC
- OFFERING AN EXTENSIVE
LINE OF FLANGE BOLTS & NUTS

YOUR STAINLESS FLANGE SPECIALIST



**ICS
FLANGE**

TEL 800-231-0360
FAX 800-586-2461

www.INNOVATIVECOMPONENTSALES.com

American Made

KEN FORGING

Forged Industrial Hardware



PROUD DOMESTIC MANUFACTURER USING **AMERICAN METAL** AND **AMERICAN PRIDE** SINCE 1970

CARBON | ALLOY | STAINLESS • 1/4" - 2 1/2" | 6MM - 64MM

SERVICE IS OUR STRENGTH

NO MINIMUM ORDERS
ALL ITEMS IN STOCK
SHIPPING FROM CA & OH
EDI CAPABILITIES
SPECIAL PACKAGING
BAR CODING
FULL TRACEABILITY
MODIFICATIONS AVAILABLE
COMPETITIVE PRICING
QUANTITY DISCOUNTS
INVENTORY PROGRAMS
TECHNICAL SUPPORT

QUALITY IS OUR COMMITMENT

EYEBOLTS
NUT EYEBOLTS
EYE NUTS
C-CLAMPS
MACHINE CLAMPS
D-RINGS & CLIPS
PAD EYES
ROD ENDS
SWIVEL HOIST RINGS
T-SLOT BOLTS & NUTS
TURNBUCKLES
CUSTOM FORGINGS
UP TO 250 LBS



TOLL FREE: 888-536-3674
sales@kenforging.com
www.kenforging.com



Jim Truesdell

James Truesdell is President of Brauer Supply Company, a distributor of specialty fasteners, insulation, air filtration, and air conditioning with headquarters in St. Louis. Mr. Truesdell is adjunct professor at Saint Louis University and Webster University. An attorney and frequently published writer, he is the author of "Total Quality Management: Reports From the Front Lines".

INFRASTRUCTURE REBOOT CAN'T WAIT!

President Trump has prided himself on fulfilling his campaign promises. One of those he held forth on in great detail was his call for modernization of the nation's infrastructure. A smoothly functioning system of roads and bridges, water and sewer management, freight and rail ports, and an up-to-date electrical grid is crucial to a country's health and economic well being.

Our current infrastructure was largely put in place many decades ago and is falling behind many emerging countries who have been building them anew. This inadequacy is compounded by the size and complexity of our society which puts incredible strain on this critical underpinning.

Unlike many of the President's proposals, the call for spending on infrastructure seemingly has broad partisan support. Conservative business people understand the need for adequate and modern support underlying our vital services. Liberal advocates of consumers and working people envision the project as creating jobs and opportunities as well as meeting the health, safety, and convenience needs of the consumer. This should be a "no brainer". Yet progress has been slow. It's time to move this project to the front burner and enact a comprehensive solution.

Despite his resolute approach to many issues, the President did not bring forth an infrastructure plan until some eighteen months into his administration. His proposal called for investing \$1.5 trillion to improve infrastructure with a target of \$200 billion in direct federal spending with the remainder to come from incentivized

private investment. The federal permitting process would have red tape cut so that it could be accomplished within two years. Particular emphasis would be on rebuilding rural infrastructures which have been wearing out badly and then on improving the training of our workforce to handle both the quantity and complexity of new systems. The plan seemed short on specifics,

however, and things seemed to get bogged down in the Congress. Congressional leaders appeared to be putting the passage of a large scale infrastructure package on the shelf temporarily as they awaited the midterm elections. Strategy focused more on smaller bills with specific reauthorizations of spending on issues such as water resources and aviation projects. Unfortunately, if the approach is piece meal we are likely to have a disjointed and patchwork plan which will only serve to compound the already existing problems of inconsistency and cost overlays with many key components left out.

To get things jump started, a coalition has been formed with diverse stakeholder. Membership in this group ranges from trade associations to labor unions and from manufacturing to finance and construction. Over 120 different parties have so far come together in the "Infrastructure Working Coalition" to urge Congress to pass a large-scale comprehensive package to revitalize the country's infrastructure and drive economic growth.

While there is indeed bipartisan support for infrastructure revitalization, the two political parties do differ in their preferred approaches.W





ADVANCED TECHNOLOGIES

A family owned business since 1955, ND Industries specializes in the development of innovative materials and processes which increase the safety and reliability of fastener assemblies.

ND serves a global market with divisions in the continental US, facilities in Taiwan and China, and licensees around the world. ND's core business revolves around the application of a wide variety of materials onto fasteners and assemblies to aid in functions such as locking, sealing, masking, lubricating, and noise and vibration dampening. ND also manufactures a line of bottled products under the Vibra-Tite® brand name for MRO and retail use.



ND continues its tradition of cutting edge research and development with the regular introduction of unique materials along with competitive brand offsets.

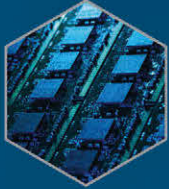
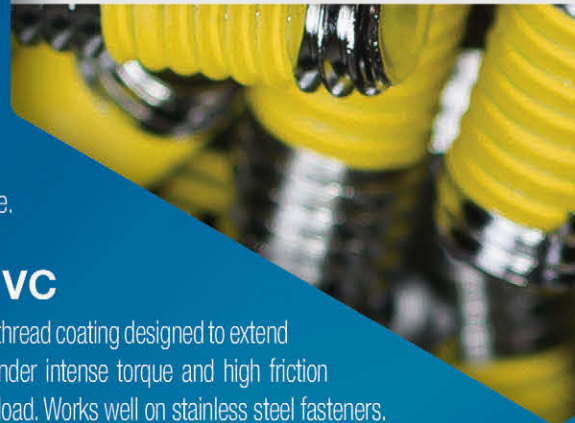

ELECTROLOC™

High strength encapsulated epoxy threadlocker for use in electrical systems where low halogen materials are necessary. Contains small micrometer microcaps which reduce material extrusion on installation.



EXPAND-A-SLEEVE™

Extruded ND Mastics are pre-applied to fasteners (threaded or non-threaded), bond for e-cote cycles. Heat from the process causes the material to expand, sealing large leak paths between fastener and assembly.



THREAD ARMOR® GP

Prevents galvanic corrosion in assemblies with dissimilar metals, such as aluminum and steel, by electrically insulating the fastener. Specially bonded to the part, Thread Armor GP is durable, chemical resistant, and non-conductive.



THREAD ARMOR® VC

An advanced anti-galling and lubricating thread coating designed to extend the life of bolts up to 15 times while under intense torque and high friction loads. Helps to ensure consistent clamp load. Works well on stainless steel fasteners.

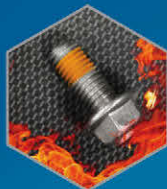

ND PATCH® HI-TEMP

Highest temperature pre-applied nylon threadlocker in the industry. Unlike the competition, ND's application process requires only 120°C, preventing plating damage. However, once cross-linked, it can withstand temps up to 260°C. Meets MIL-DTL-18240F / QPL-18240.

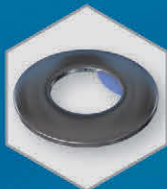

STAY-PUT® WASHERS

Whether you're looking for pre-assembly of parts, temporary retention, or an alternative to SEMS screws, Stay-Put simplifies the process by making practically any metal washer self-retaining.



THERMOLOC® 1500

ND's highest temperature chemical threadlocker. Initially performs like a vibration dampening compound. Once temperatures reach 750°F (400°C), a secondary activation begins, causing the fastener to be permanently locked in place. Tested to over 1500°F (850°C).



**AUTHORIZED
APPLICATOR**

Did you know that ND is an approved 3M applicator? Further proof why ND should be your one stop shop for pre-applied fasteners.

CONTACT US

info@ndindustries.com
www.ndindustries.com
www.vibra-tite.com

MAThread®, ACR Phillips II® and Phillips Square-Driv® (PSD)® Systems by HI-PERFORMANCE



MADE IN THE USA

MAThread® is a misalignment accommodating thread that provides increased efficiency in installation by guiding the screw into its mating part with ease. It prevents cross-threading and camming out.

ACR Phillips II® and Phillips Square-Driv® (PSD)® Systems are proprietary systems that help with cam out and reduce scrap and re-work upon installation. Offering a stick-fit design, Square-Driv® allows you to assemble a product to its mating part single-handed without the fastener falling off the bit.



**Hi-Performance
Fastening System**

For more info: 630.860.7766 | info@mw-ind.com

distributornews

The Auto Bolt Company, Company is proud to share the news that we have received quality certification to ISO 9001:2015. We were previously certified to ISO 9001:2008, and this new level of certification confirms our commitment to manufacturing quality parts within a quality management system.

Auto Bolt, located in Cleveland, Ohio, is an independently owned manufacturer of quality fasteners since 1948, specializing in offering both low and high-volume performance and commercial fasteners. Auto Bolt is a leading provider of fasteners for various industrial, distribution and original equipment markets and applications to include Truck and Trailer, Military, Construction and Agricultural equipment, as well as Automotive components. Our product ranges in size from ¼" (M6) through 1" (M24) diameters on single and multiple station forming equipment, with long stroke capabilities to produce product up to 12" (300 mm) in length.

For more information contact *The Auto Bolt Company* at 4740 Manufacturing Rd, Cleveland, OH 44135. Toll-free: 1-800-988-BOLT, Tel: 216-881-3913, Fax: 216-881-3918, Email: inquiries@autobolt.net or visit them online at www.autobolt.net.

Standard & Metric Domestic Manufacturing

**Hex · Heavy Hex · Square Head · Socket
Flat Socket · 12-Point · Specials**

1/2" - 4" & M16 - M100 Heading Diameters



Large Blank Inventory



Copper State Bolt & Nut Co.
Manufacturing Division

MFGBranchSales@copperstate.com

800-528-4255



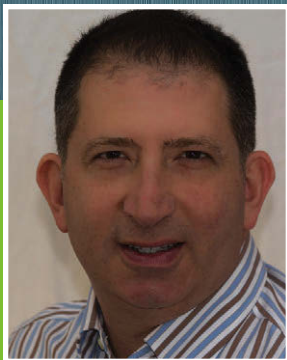

Salim Brahimi Director of Engineering Technology

INDUSTRIAL FASTENERS INSTITUTE

636 Oak Tree Blvd., Independence, OH 44131

TEL 216-241-1482 FAX 216-241-5901

EMAIL sbrahimi@indfast.org WEB www.indfast.org

IFI BOOK OF FASTENER STANDARDS 2018 EDITION

HARDCOVER AND A NEW ONLINE EDITION WILL BE AVAILABLE IN SEPTEMBER 2018!

The 2018 Edition of the IFI Book of Fastener Standards, also known as the "10th Edition" is now available for PRE-PUBLICATION PURCHASE in the traditional hardcover format and a NEW online format called the IFI Online Book of Fastener Standards.

The 2018 Edition IFI Book of Fastener Standards is an essential compilation the most commonly used fastener standards for inch fasteners and non-ISO metric fasteners. The book contains 92 separate standard specifications issued by ASTM, ASME, SAE and IFI. The 2018 IFI Book of Fastener Standards is the tenth edition of the Book of Standards published by the Industrial Fasteners Institute. This edition represents 77 years of continued development in fastener standards and practice since IFI published the first edition in 1941. The IFI Book of Standards is considered a "BIBLE" for designers, manufacturing engineers, and managers in all industries, and major manufacturing and construction interests throughout the world use the IFI Book as an authoritative reference for fastener technical data. The 2018 Edition, in hardcover and online platform, is the next step in continuing a tradition of dedicated service to the fastener supplying industry and the companies they serve.

The Book Organization

As with the 9th Edition. This new edition has been organized to make finding the standards easy. Dimensional standards are at the beginning of each product section followed by the related material standards. For example,

the dimensional data for a bolt is given in ASME B18.2.1, located is in the front of the Bolt Section, which also contains the material standards for SAE J429, ASTM A193, etc.

The Book Includes Dual (Inch and Metric) Standards

The title of the 2018 Edition does not contain the term "Inch" because many of the standards have been combined into dual inch/metric standards. For example, ASTM F606 and its metric companion ASTM F606M have been combined by ASTM Committee F16 on Fasteners to form a dual inch/metric standard designated ASTM F606/F606M. Although the term "Inch" was omitted from the title, this book fundamentally remains the comprehensive reference source for "Inch" fastener standards. IFI no longer publishes a Metric Fastener Standards Book.



Companion Book - IFI Fastener Technology Handbook

As with the preceding 9th edition, this 2018 Edition contains the standard specifications only. An extensive body of technical information and commentary on all matters related to fasteners is contained in the IFI Fastener Technology Handbook. This separate book is sold as a companion to the Book of Standards and is available in the Reference Books Section of the IFI online store.

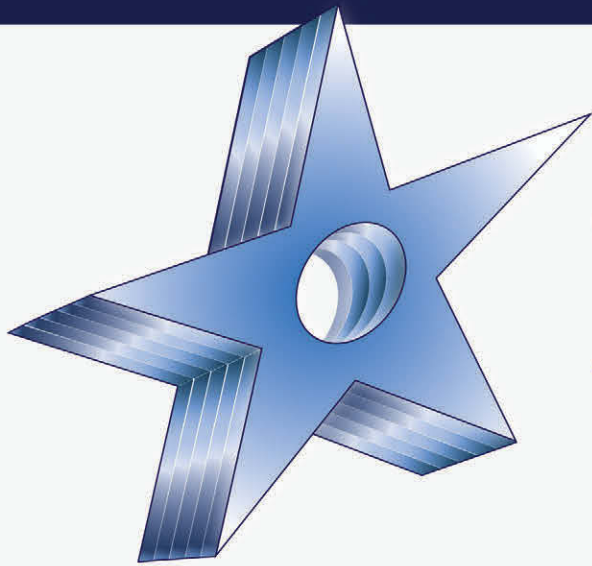

STAR

STAINLESS SCREW CO.

We have a huge inventory!

RIGHT-OFF-THE-SHELF®

I-N-S-T-A-N-T STOCK®



STILL THE LARGEST

and most

VARIED INVENTORY of

18-8, 316 & 410 Stainless



STAINLESS FASTENERS ANYWHERE!

Standards, Non-Standards, Import, Domestic, Inch, Metric



Call us...
We love talking to our customers!

New Jersey 973-256-2300
Houston 713-863-0641
S. California 323-726-0106
N. California 510-489-6569

Atlanta 770-662-0835
Chicago 630-595-3440
Pittsburgh 724-772-3422
Seattle 253-859-2133

Tampa 813-622-7578
New England 860-289-8646
Dallas 972-606-5900
Ontario, Canada 905-646-0290

CERAMCO, INC.

1467 E Main St., Center Conway NH 03813

TEL 603-447-2090 FAX 603-447-3906 EMAIL stock.fasteners@ceramcoceramics.com WEB www.ceramcoceramics.com/link



Ceramco, Inc.

DEMYSTIFYING SOLID CERAMIC FASTENERS - SOLID CERAMIC FASTENERS 101

Solid ceramics have been used in industrial and commercial applications for decades. Since the 1980's, ceramics have rapidly evolved, meeting the ever-increasing demands that technology, environmental concerns, safety and cost control have placed upon industry and manufacturing. Yet, to many... ceramics remain somewhat of a mystery.

Since 1982 Ceramco, Inc. has been manufacturing solid ceramic components (including fasteners) remaining an integral part of ceramic's evolutionary development. Along the way Ceramco realized the need for stock solid ceramic fasteners and pioneered the solution to that need with its line of stock bolts, washers and hex nuts.

While all this is well and good, as a fastener distributor we appreciate your need for an understanding of why you should consider stocking solid ceramic fasteners, moreover recommending them to your customers. Providing you with a basic understanding is the objective of this article.

Solid Ceramics Defined

Ceramic fasteners are most often classified as technical or engineered ceramics; oxides of alumina and zirconia. From high school science we know that an oxide results from oxidation.

Ideal Environments & Applications

[1] Oxidation & Corrosion - Solid ceramic



fasteners are already oxides. As such they are unaffected by the oxidation process. Solid ceramic fasteners possess exceptional resistance to strong acids and other chemicals as well. The ability of solid ceramic fasteners to resist oxidation and corrosion (in some cases entirely) is the primary reason they are the material of choice for hostile environments.

[2] Electrical Insulation - To be considered an electrical insulator, there must be an absence of electrical conduction. Solid ceramic fasteners (especially those of alumina) are inherently non-conductive. This property can be critical in both high and low voltage environments from 300kV to 70eV as an example. Ceramics are often used in RF (radio frequency) applications and in capacitors.

distributornews

Lee S. Johnson Associates, Inc. is proud to celebrate anniversaries with the companies we represent. Our agency has been a proud partner of these companies for 20 years or more and we look forward to continuing that partnership for growth for many more years.

These companies exemplify what it means to work through the good and bad times in the economy with their salesforce and keep the course no matter how easy it may be to change it- that's why these companies are stalwarts in the fastener industry. To say you worked with a company for 20+ years in our industry is saying something about both party's character and performance level.

- ▣ Western Wire Products
- 26 years.
- ▣ KDS Imports
- 25 years
- ▣ Minneapolis Washer
- 24 years
- ▣ FTZ Industries - 24 years
- ▣ Drillco Cutting Tools
- 21 years
- ▣ Locknut Technology
- 20 years
- ▣ Fall River Manufacturing
- 20 years
- ▣ E W Daniels
- 20 years

We have been with 85% of our principals for 12 years or more...ex. Lindstrom, Anderson Metals, Chrislynn etc...

For more information contact Lee S. Johnson Associates toll-free at 1-877-634-7377. Email Lee Johnson Jr. at leejohnsonjr@comcast.net or visit them online at www.lsjassoc.com.

Build Your Profits on a Solid Base

Solid Ceramics

Specialty Fasteners for Specialized Applications

Solid ceramic fasteners are a low volume, high profit item solving customer problems that other fasteners can't solve. When other fasteners are approaching their limits, solid ceramic fasteners are just beginning.

Comprehensive Selection - For immediate delivery Ceramco stocks a comprehensive selection of head styles, sizes and lengths, including hex nuts and flat washers in both U.S. Inch/SAE and Metric.

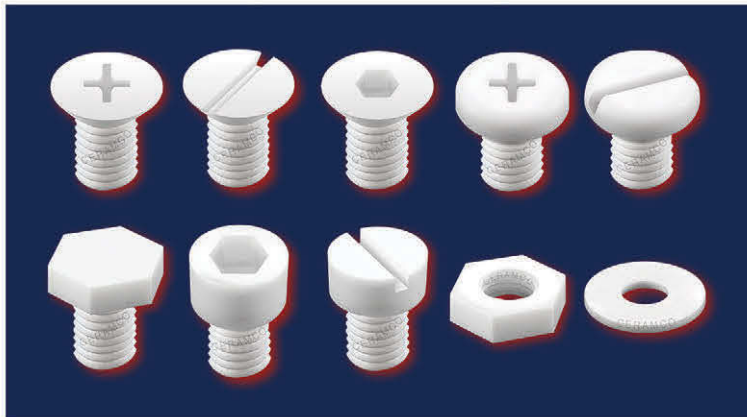

Applications - Ceramco's solid ceramic fasteners are ideal for: High Temperature, Corrosion & Wear, High & Low Voltage and Leak-free Vacuum environments.

Quality Assurance - Ceramco's solid ceramic fasteners are made in the USA, ISO 9001-2015 certified and ITAR approved.

Profitability - In addition to discounted pricing, stocking distributors are eligible for bonus commissions when annual sales goals are met. Drop-ship arrangements with discounted pricing also available.

Materials Comparison* Rating: 1 - 4 (4 being best)

Material	Maximum Service Temperature	Thermal Conductivity	Electrical Conductivity	Volume Resistivity	Coefficient of Thermal Expansion
CERAMICS					
Alumina (99.8%)	4	4	4	4	3
Zirconia TZP‡	3	4	4	4	4
OTHER MATERIALS					
Molybdenum	4	1	3	2	4
Nylon 6,6	1	4	4	4	3
Stainless Steel	2	2	3	1	1
Titanium	3	3	2	1	2

* These ratings are averages intended for quick comparison only. No guarantee should be assumed or is implied.

‡ Yttria Stabilized.

ISO 9001
ITAR



Ceramco, Inc.

Made in
the U.S.A.

+1 603-447-2090 • www.ceramcoceramics.com/link • stock.fasteners@ceramcoceramics.com

GLOBALFASTENERNEWS.COM

by **JOHN WOLZ** EDITOR
 editor@globalfastenernews.com



U.S. FASTENER MANUFACTURERS GET INCONSISTENT 232 TARIFF WAIVER RESPONSES

U.S. fastener manufacturers continue to receive “very inconsistent responses from the U.S. Commerce Department” related to exclusions from the 232 tariffs on steel and aluminum, according to Industrial Fasteners Institute’s Washington representative Jennifer Baker Reid.

A few IFI members applying for a waiver from the tariffs have received “information incomplete” responses from the Commerce Department, Reid told FIN. But Reid is unaware of any IFI member that has received a waiver for steel.

“The Commerce Department continues to be overwhelmed, the process is inconsistent at best, and tilted to steel industry at worst,” Reid told FIN.

Despite the lackluster response, companies are reluctant to publicly air concerns if they are awaiting waiver decisions from the Commerce Department.

“If you’re a publicly traded company, you don’t want to be the next Harley-Davidson,” Reid stated.

Reid noted that members of Congress have begun to push back against the 232 tariffs by introducing bills to alter the President’s authority under 232 to levy tariffs. But politics may delay those efforts.

“Concern has grown in Congress, but I think it will be very difficult to get a tariff bill passed before the midterm elections,” Reid told FIN.

Reid urged fastener companies to provide Congress “real examples of real companies in real pain,” but she acknowledged that many companies are uncomfortable making public statements.

And unlike the 201 tariffs former President George W. Bush imposed in 2002, the 232 tariffs under Trump have no specified review or sunset clause.

“My gut tells me we will need to convince the Administration to lift the tariffs,” Reid stated.

Reid said negotiations with other countries may have a more immediate effect on Trump’s 232 tariffs.

“I don’t see the EU agreeing to a trade deal that doesn’t address steel and aluminum tariffs,” Reid told FIN. “Frankly I can’t see Canada or Mexico doing that either.”

Reid said she is encouraged by Trump’s decision to delay auto tariffs with EU automakers while the countries pursue further negotiations.

But she warned that the U.S. has not fully felt the impact of the 232 tariffs. Some companies have been insulated from the impact by year-long contracts, but that’s rapidly coming to an end.

“The U.S. is an island of high steel prices right now,” Reid told FIN. “The overall healthy economy is masking the pain of these tariffs, but I don’t know how long that will stay the case.”

The issue is not limited to imported steel.

“Domestic prices have jumped,” Reid noted. “Your prices are up no matter what.”

Reid said domestic companies might still be able to get imported product with the tariff and still pay less than buying domestic.

“We may have created a situation where the U.S. government is incentivizing businesses to import products,” Reid told FIN.

But some fastener manufacturers, especially automotive and aerospace companies, can’t simply shop around; their OEMs would need to approve their suppliers. (www.IndFast.org).

SPACERS & STANDOFFS



HEX & ROUND FROM 3/16" TO 3/4" IN DIAMETER

MANUFACTURED IN BRASS, ALUMINUM, STEEL & STAINLESS STEEL



W.J. Roberts Company, Inc.

181 Central St, PO Box 1146, Saugus, MA 01906 Tel: 781.233.8176 Fax: 781.231.1456 Email: wjroberts@verizon.net



visit our new website at www.wjroberts.com



RIVETS

HUGE INVENTORY

Aerospace & Commercial
From 1/16" to 1-1/2" Diameter!



- Tubular Rivets
- Blind Rivets
- Solid Rivets
- Drive Rivets
- POP®, Avdel® & Southco®
- Split Rivets
- Belt Rivets
- Binder Rivets
- Tanners Rivets
- Brake & Clutch Rivets
- Rivet Caps
- Rivet-Nuts
- Speed Fastening®
- Blind & Press-In Threaded Inserts
- Self-Clinching Captive® Fasteners
- Back-Up Washers
- AN, MS, NAS, LS, BACR
- Custom Rivets & Fasteners
- Riveting Tools & Accessories
- Riveting Machines & Tooling



HANSON RIVET
& SUPPLY CO.
13241 Weidner Street
Pacoima, CA 91331

SINCE
1929

www.hansonrivet.com

Please ask for Distributor Sales
1-800-RRRIVET
(800-777-4838)
FAX: 818-485-0540

INTERNATIONAL FASTENER EXPO

TEL 323-817-2226 FAX 310-481-1909 EMAIL morgan.wilson@emeraldexpo.com WEB www.fastenershow.com

IFE ANNOUNCES 2018 AWARD WINNERS



The International Fastener Expo has partnered with the Fastener Industry Coalition to choose the winners of the Fastener Hall of Fame and Young Fastener Professional of the Year Award. The Fastener Hall of Fame Award recognizes and honors inventors, business leaders, and educators who have made significant contributions to the fastener industry. The Young Fastener Professional of the Year Award recognizes and honors a young professional under the age of forty who has made significant contributions to the fastener industry.

A special recognition award ceremony will take place on the show floor in the Sessions Corner at IFE in Las Vegas, NV on Wednesday, October 31, 2018 from 2:30-3:30pm.

Hall of Fame Award Winners



Bob Sachs
XL Screw Corporation

In 1979, Bob Sachs became a shareholder and Vice President of XL Screw Corporation. In January 2003, Bob was promoted to President. Owning 100% of XL was a lifelong goal and through hard work and dedication, that dream came true in 2005. Under Bob's leadership,

XL is a major contributor to the distribution market..."a company you can always count on." XL will be celebrating 50 years in business in November 2018. Please join us in congratulating XL on their 50 year milestone.



Robbie Gilchrist
Capital Marketing

Robbie Gilchrist is in his 47th year in the fastener business. Each day communicating with many industry people. Throughout the years he was President of the SEFA, serving on the board for two terms; served on the board of the NFDA and was a committee chair for three years, in all trying to improve the fastener industry.

The greatest part of Robbie's career has been the formation and distribution of "The Gilchrist Foundation". The Foundation was formed after the sale of Capital Fasteners in 2000 to assist students in their continuing education. Robbie and his wife Gina of 31 years, had been successful and wanted to give back to the industry that had been so supportive of them. Since the inception of the scholarship endowment, 60 scholarships have been awarded to people working in the industry or family members of those working in the industry.



WHO HAS TIME TO WAIT?

Inch & Metric Sizes | DFARS Compliant Material | Over 34,000 SKUs | Most Sizes Available From Stock



Shoulder Screws
The largest line of ASME and Precision standard in 18-8, 316, 316 H5® and 17-4 PH Stainless Steel, Aluminum, Brass, Grade 2 & 5 Titanium and Monel.



Socket Head Cap Screws
Semi-standard sizes, extra-long lengths, special head configurations in high performance materials.



Low Head Products
AMPG specializes in low profile head binding barrels, shoulder screws, socket screws and other items for reduced head clearances.



Prairie Bolts™
Prairie Bolts are ordered by 'grip length'. The grip length is the unthreaded shank and measured from under the flange to the beginning of the threads. Available in 1/8" increments.



Binding Posts & Barrels
Binding posts, barrels and screws offered in many materials. Available in socket, slotted, one-way, 6-lobe, combo and tamper-resistant drives.



Extra Thick Washers & Shims
Inch and Metric washers available from 3/8" thick and up; outside diameters up to 14". Square washers are also available.



Nuts
Too-tall acorn, coupling, finger, round panel and hex nuts in coarse, fine and extra fine threads.



Standoffs & Spacers
Spacers, structural standoffs and glass fastening components.



Search our online catalog at ampg.com.

8090 Woodland Drive | p: 317.472.9000
Indianapolis, IN 46278 | f: 317.472.9010



Robert Footlik

Robert B. Footlik, PE is a retired Professional Industrial Engineer. With over 50 years' experience as a Warehouse and Logistics Consultant to a wide variety of clients including Fastener Distributors, Bob has a wealth of valuable information for our industry and he is willing to share it. While Footlik & Associates is now closed, his expertise is still available to his friends and our readers. For friendly advice, a second opinion or just to start a conversation, he can be reached at robert@footlik.net.

PRE-PLANNING CAN SAVE YOUR BUSINESS AND YOUR LIFE

If there is one commodity that the Fastener Industry has in abundance it's 20-20 hindsight. Unfortunately by the time one has the opportunity to look backward the past is already over and it's too late to do anything about it. This is especially true when planning for disaster events that are unpredictable. In this regard recent mud slides, volcanic eruptions and earthquakes have been a real "wake up call" for everyone. While recessions can take months to build, earthquakes, tornados, fire, hurricanes and vandalism can take only minutes to devastate a business that took decades to implement. But with some preplanning and moderate advance efforts the effects can be minimized.

Disaster planning falls into three broad categories: preplanning for emergencies, actions during the event and operation/salvage/restoration when the dust settles or the fire is extinguished. Each of these steps is important, but preplanning is the most readily controlled and will dictate most subsequent actions. It is the key to emerging from adversity stronger and more viable than before the calamity.

Start With "Who"

Regardless of the size of the organization the best and most efficient team must have a leader. One individual ultimately must make on the spot decisions, preferably working according to a well orchestrated and comprehensive plan. This individual should have the total perspective and while they may delegate tasks theirs is

still the final authority. Right or wrong the "buck stops here." A "Disaster Manager" can be you, the warehouse or operations manager, the head of maintenance or any of your key personnel who can handle the responsibility and make level headed, rational decisions in the heat of the moment. Committee meetings and votes are definitely going to be too little, too late or all the wrong decisions.

Company size and complexity will dictate the organization required to implement a comprehensive plan. With more departments and divisions it becomes increasing important to review the needs of each area separately. For example, a simple way of mitigating data disasters is with a regular program of frequent back up copies. But where will these be stored? On site storage has obvious problems, but off site computers and systems



reachable only via non-existent phone communications or destroyed Internet infrastructure are little better. Backing up to a portable memory card or disk entails other risks. The disaster plan must address these potential problems with appropriate procedures and redundancies.

Less obvious are the procedures to keep the business in operation on a day to day basis. The most common occurrence is a loss of power. Simply keeping electric forklifts charged on a regular basis is a good zero cost idea. Adding a hook up point for an emergency generator is a cheap way of providing power quickly, provided the plugs are compatible with readily available rental equipment. Someone needs to identify these opportunities now, not after disaster strikes.



MANUFACTURED IN THE USA AND COSTA RICA

DOMESTIC QUALITY AT IMPORT PRICES

MANY ITEMS FROM STOCK

Knobs



Clamping



Snap-Lock Knobs



Soft-Touch Knobs



Press Fit – No Threads



Two Tone



Ball Knobs



Custom, Raised Lettering and Pad Printed



Control Knobs



Metal Knurled Knobs



Press On Thumb Screws



Quick Release Pins



Ring Detent Pins



Wire Lock Pins



Lynch Pins



Knob Detent Pins



Magnetic Selector Pins

Spring Loaded Pins



Pop Pins – Lockout



Plunger Pins



Positive Locking Pins and Receptacles



Thread Detective®



Thread Identifying Tool

Nylon and Brass Tipped Fasteners



Lanyards



CNC Screw Machine



Custom Molding



Swell Latches



for Innovative Solutions



IFE Show in Vegas
Oct 30 – Nov 1
Booth 2854



STAFDA Convention
in Phoenix Oct 28 – 30
Booth 1807

For more information call 800-566-2774
or visit our website at www.knobsource.com

NATIONAL FASTENER DISTRIBUTORS ASSOCIATION

3020 Old Ranch Parkway #300, Seal Beach CA 90740

TEL 562-799-5509 FAX 562-684-0695 EMAIL nfda@nfda-fasteners.org WEB www.nfda-fasteners.org

NFDA NEW MEMBER DEAL: SAVE 50% by Vickie Lester

NFDA is pleased to offer 50% off every new member's dues, for those who apply now until December 31, 2018! To apply, visit www.nfda-fastener.org and scroll down to the "Join NFDA" button. At the payment section of your application, simply apply the promo code 500FF.

NFDA's benefits include

- Economic Update Reports from ITR Economics (quarterly)
- Profit Improvement Reports from the Profit Planning Group (quarterly)
- Free weekly access to the Kiplinger Letter (concise weekly forecasts on business and economic trends)
- Free annual Profit Report and biennial Employee Compensation Report (for those you participate in the surveys)
- Discounted registration to all NFDA meetings
- Discounted registration to all Fastener Training Institute programs
- Discounted registration to quarterly Sales Professional Training programs
- Discounted registration to annual University of Innovative Distribution events, free quarterly
- Member database access
- Business services discounts for FastenersClearinghouse.com, YRC Freight Shipping and much more.



To view the full list of member benefits, dues levels and more, visit www.nfda-fastener.org. If you have any membership questions that were not answered by visiting the website, contact NFDA's Community Manager, Marci Myer, marci@nfda-fastener.org and she will be happy to help you.

NFDA Members Also Can Receive Dues Discounts

If you are an NFDA member in good standing and a new member reports on the application form they were referred by your company, you get \$1,000 off your next dues payment.

NFDA, MWFA, and Pac-West Partner for Joint Meeting

Save these dates: March 13-16, 2019. That's when NFDA partners with the Mid-West Fastener Association and the Pacific-West Fastener Association for a joint meeting at the Omni Hotel in downtown San Diego's Gaslamp District. Meeting details will be available in November.

For more information about NFDA and its activities, visit www.nfda-fastener.org or contact Vickie Lester, CAE, vlester@nfda-fastener.org, 562-799-5519.

Tortoise Fastener Co.

Your Specialty Source for Slow Moving Hex Heads

Why did the tortoise cross the road?

To get to the shell station!



We move slowly®

Contact us today
for hard to find
Hex Heads!

- Stainless** 
- Brass** 
- Silicon Bronze** 
- Aluminum** 
- Alloy 20** 
- Nickel-Copper** 

phone: 800-691-8894

email: sales@tortoisefastener.com

Offshore Milling Services, Inc.

Your One-Stop Source
for Factory-Direct
Fasteners

25

COMMITTED TO OFFERING
HIGH QUALITY, EXCEPTIONAL
SERVICE TO OUR PARTNERS
FOR OVER 25 YEARS.



**IMPORTING HAS IT'S RISKS -
LET US HANDLE IT FOR YOU!**

WE ARE THE EXPERTS IN SOURCING HIGH QUALITY SPECIALS AT COMPETITIVE PRICING. WHATEVER YOUR IMPORT NEEDS, OUR EXPERTISE STREAMLINES THE ENTIRE PROCESS - PROMISING EXCEPTIONAL CUSTOMER SERVICE AND ON-TIME DELIVERY. WE OFFER A FULLY-INCLUSIVE SERVICE - FROM ORDER, TO DELIVERY TO YOUR DOOR.

QUALITY IMPORTED FASTENERS MADE EASY.

STAINLESS STEEL FASTENERS | DIN/JIS/METRIC FASTENERS | EYE BOLTS | ALUMINUM BOLTS | STAMPED PARTS | BUSHING PARTS | RIVETS
PINS | SPECIALTY FASTENERS | SEMS SCREWS AND PARTS | LEFT HAND BOLTS | STAINLESS BOLTS | WELD NUTS | T-NUTS | LOCK NUTS
CONICAL WASHER NUTS | TAMPER-PROOF SCREWS | SCREW MACHINE PARTS | SECONDARY OPERATION PARTS | ROBOTIC WELDED PARTS

Tel: 503-244-1516 | Fax: 503-452-9855 | Email: info@offshoremilling.com | www.offshoremilling.com

DISTRIBUTION ONE

4004 Church Road, Mount Laurel, NJ 08054

TEL 856-380-0629 FAX 856-222-0061 EMAIL info@distone.com WEB www.distone.com

DISTRIBUTOR TOOLS FOR HARNESSING THE POWER OF AMAZON

For wholesale distributors in any industry, Amazon is most likely the largest elephant in the room. In fact, a 2017 Berg Research survey¹ revealed that 92% of wholesale distributors either strongly agree or somewhat agree that Amazon is currently one of their biggest competitors. Understanding this, the question becomes, “what are my options?”

Currently, companies are opting to avoid Amazon versus, as in Walmart’s case, trying to battle it head-on. While navigating their avoidance route, many distributors discover they lack the technological investment necessary to streamline their own processes. As expected, their business processes become bogged down by their own inefficiencies which is not a successful model for sustained growth in the age of Amazon. In the latter example, conversely, a distributor must have substantial capital to be able to go toe-to-toe with the E-commerce titan.

If neither of those choices seem particularly appealing, there’s a viable third option embodied by the adage: “If you can’t beat ‘em, join ‘em.” Instead of ignoring Amazon, wholesalers and distributors must learn to leverage its benefits to their advantage. Let’s cut through the jungle to examine the rewards of technology and Amazon integration.

The Berg Research study reported that only 58%

of wholesale distributors are currently using connected technology while 55% make use of tablets to place orders. Technology adoption is necessary to sustaining long-term growth. Moreover, smart distributors invest in established comprehensive business software that not only delivers ongoing cost savings by eliminating inefficiencies but also expands sales opportunities via Amazon’s Global Marketplace.



Distribution One’s ERP-ONE+ software solution delivers comprehensive process functionality, Cloud accessibility, dashboard analytics, and expanded features like mobile apps and the Amazon integration

distributors need to make Amazon work for them.

Ordering

Supplemental ERP-ONE+ connectivity into Amazon Seller Central streamlines the ordering procedure via auto-updates and rapid processing. Orders and inventory data flow seamlessly between your software and Amazon providing both faster turnaround and enhanced order accuracy. Distributors have the added convenience of clicking a checkbox to add new items for sale. ERP-ONE+ enables distributors to easily maximize their selling opportunities across Amazon’s vast customer network. Integrated Dashboard+ analytics provide strategic insight into the real-time health of the business.

DISTRIBUTION

One

INCREASE PRODUCT VISIBILITY ON

AMAZON



SALES INTEGRATIONS FOR FASTENER DISTRIBUTORS

Looking to expand sales opportunities into Amazon? Distribution One's **ERP-ONE+** business software can clear a path through the jungle.

Utilizing supplemental **ERP-ONE+** connectivity, fastener distributors can successfully expand the scope of product visibility and online selling through an automated order process. Amazon integration eliminates manual data entry between systems and provides distributors the ability to sync vital data including sales orders, inventory levels, and shipping updates.

Experience enhanced turnaround, inventory accuracy, and selling opportunities through Amazon and **ERP-ONE+**.

ERP
One+

Start expanding your fastener sales at
DISTONE.COM/AMAZON-FOR-FASTENERS

SPECIALTY TOOLS & FASTENERS DISTRIBUTORS ASSOCIATION

PO Box 44, 500 Elm Grove Rd., Ste. 210, Elm Grove, WI 53122
 TEL 1-800-352-2981 FAX 262-784-5059 EMAIL info@stafda.org WEB www.stafda.org

STAFDA'S PHOENIX CONVENTION & TRADE SHOW RISING TO THE OCCASION by Georgia H. Foley, CEO

Just like the phoenix rises from the ashes to soar, STAFDA's October 28-30 Phoenix Convention & Trade Show has been flying high ever since registration opened on June 25.

The exhibit hall was 90% sold out by mid-July and is nearing capacity. However, STAFDA has another hall on "stand-by" to accommodate more exhibitors in case the current 226,500 sf halls max out. The five host hotels in STAFDA's housing block quickly sold out along with three overflow hotels. As more housing is added, it's being posted to STAFDA's website.

STAFDA's three-day meeting is a balance of education and a trade show. The meeting leads off with four morning workshops that repeat to a difference audience following a break, allowing attendees to attend the two of most interest. Or if multiple people are in attendance from a company, they can divide and conquer all four programs.

The education on Sunday, October 28 features four, topical, business sessions: Social Selling: Leverage Social Media to Sell More (Bob DeStefano); Leaders are not born: They're Built (Randy Disharoon); Selling Boldly: How to Grow Sales 15% Annually (Alex Goldfayn); and How

to Improve Distributor Profitability (Greg Manns).

As many current owners transition their company to the next generation or a key employee, business succession is an important subject. Many people don't know how to set a course on transition but STAFDA consultants, Ryan Barradas and Tim Young, will point attendees in the right direction during their Sunday afternoon program, Putting Success Back in Succession.

An equally pressing concern pervasive throughout the construction channel is attracting the younger generation to distribution and

the supply chain. For the second year, STAFDA is inviting college students with industrial distribution, construction management, and supply chain majors to the Convention. They'll attend educational workshops, the Young Professionals Luncheon, General Session, and Trade Show, but more importantly, they'll participate in a Speed Interviewing Session for three hours Sunday afternoon. Appointments will be scheduled beforehand, but STAFDA attendees wishing to interview students for jobs or internships will man tables and have 15 minutes to meet them and discuss opportunities. After 15 minutes, the student will rotate to another STAFDA member. Students' resumes will be posted to the members-only section of STAFDA's website beginning October 8 so attendees can preview candidates. The STAFDA office will coordinate the interview appointments.

Sunday ends with bang when STAFDA hosts its Opening Party at CityScape, a downtown enclave of restaurants, a comedy club, bowling alley, and more! Walkable from all STAFDA hotels and the Convention Center, attendees will have three hours to enjoy different cuisine in each restaurant, bowl, dance, or enjoy arcade games. Part of Central Ave. will be closed down to stage the popular, local band, The Walkens. Attendees will literally be able to dance in the street!





®

Albany Steel & Brass Corporation

SUCCESSORS TO LEBOVITZ BROTHERS

DISTRIBUTORS OF FASTENERS, INDUSTRIAL & MILL SUPPLIES
SINCE 1918

1900 W. GRAND AVE.
Phone: 312-733-1900
sales@albanysteel.com

CHICAGO, IL 60622
Fax: 312-733-9887
www.albanysteel.com



ISO
9001:2015
Certified

The Only Factory Authorized Stocking Distributor of **Genuine SWAGEFORM®** High Performance Thread Forming Screws



Swageform®
is Made in the USA

Diameters 4-40
through 3/8-16
up to 1-1/4" long



**Available From
STOCK!**

All Popular Head Styles
Including:

- Slotted Hex Washer
- Unslotted Hex Washer
- Phillips Pan Head
- Slotted Pan Head
- Phillips Flat Head

Specialty Tapping Screws

Type 'B', 'F', U, '21' and TEKS®
Plasti-Kwick Plus™

Over 2,500 Sizes Available in
Convenient 100 or 1,000 packs

We Specialize in Large Diameters:
1/4", 5/16" and 3/8"

Thumb Screws

Cold Forged Steel
Plain and Zinc Plated

6-32 Through 3/8-16 up to 3" in Length

Shoulder Style and Plain (No Shoulder)

Available in 1/4-28 and 5/16-24

Wing Nuts

Cold Forged Steel
Plain Steel and Zinc Plated

Sizes Include:
4-40, 12-24, 1/4-28,
5/16-24, 3/8-24, 1/2-20

Swageform® is a registered trademark of Sems and Specials, Inc.
TEKS® is a registered trademark of ITW Buildex
Plasti-Kwick Plus® is a registered trademark of Parker-Kalon





3Q, Inc.

1707 QUINCY #159 • NAPERVILLE, IL 60540

Split Lock Washers

Large Diameter

IN STOCK NOW!



- 100% Made in the USA
- Hot Dipped Galvanized
- Regular Duty
- 7/8" to 3"
- Other styles and finishes available upon request

Quality Products • Quality Service • Quality Customers

CONTACT US TODAY!

630.405.8492 | sales@3Q-Inc.com | 3Q-Inc.com



CAPITAL MARKETING

**SALES & MARKETING STRATEGIES
FROM A PREMIER AGENCY
SERVING NORTH CAROLINA,
SOUTH CAROLINA & VIRGINIA**

Capital Marketing is headed by Robbie Gilchrist, a 40-year veteran of the fastener business and a lifetime member of NFDA - the National Fastener Distributors Association.



**CALL ROBBIE TODAY TO DISCUSS
HOW YOU & YOUR COMPANY WILL
BENEFIT FROM HIS PERSUASIVE
& ENERGETIC REPRESENTATION.**

tel: 336-906-9401 email: rgilchr485@aol.com



distributornews

Earnest Machine is pleased to announce the addition of four new employees in their corporate office in Cleveland.

▫ *Dianna Barnes* joins Earnest Machine's Sales Team. Her ability to quickly prioritize customers' requests as well as educate them on products and services will help Earnest maintain its commitment to excellent customer relationships, as well as usher in new leads and contacts.

▫ *Jared Keipert* joins Earnest's Purchasing Team in the new role of Material Analyst/Buyer. In this role, Keipert will manage the relationship between Earnest and Plating suppliers while analyzing data to assist Earnest in product expansion, which includes the company's recently introduced U.S. Domestic Finished Hex Nuts.

▫ *Jim Dowling* joins Earnest's Sales Team and brings over 10 years of experience to the company. His ability to resolve issues quickly and efficiently, along with his candor and enthusiasm to work with customers aligns with Earnest's goal of creating the best customer experience possible.

▫ Earnest Machine is also expanding the team in its Engineering and Manufacturing Facility. *Landon Patten* joins Earnest as part of an internship program with Lorain County JVS. Patten's focus is shipping and receiving. He also operates CNC lathes and conducts quality checks and completes production record keeping.

"Whether it's sales, purchasing, operations, or marketing, we're always asking 'how can we help you today,'" said Kirk Zehnder, CEO of Earnest Machine. "Our newest team members are ready to hit the ground running and we're excited they share our values of putting the customer first and creating that Intentionally Better experience we strive for."

Founded in 1948, Earnest is a global importer, distributor, and manufacturer of large diameter and hard-to-find fasteners for the agriculture, construction, heavy transportation, mining and wind industries. Earnest maintains warehouses, sales offices, and manufacturing centers in Cleveland, OH, and Wolverhampton, England, as well as warehouses in Atlanta, GA, and Indianapolis, IN.

For more information contact Earnest Machine Products by Tel: 1-800-327-6378 or visit them online at www.earnestmachine.com.



STELFAST® INC.

ISO 9001:2015 • MBE Certified



YOUR FULL LINE MASTER DISTRIBUTOR FOR INCH & **METRIC** FASTENERS

Now Stocking **METRICS**

- Hex Head Cap Screw - Partial Thread
DIN 931/960 - ISO 4014/8765
- Hex Head Cap Screw - Full Thread
DIN 933/961 - ISO 4017/8676
- Flange Bolt Non Serrated - DIN 6921
- Carriage Bolt - DIN 603
- Hex Nuts - DIN 934 - ISO 4032/8673
- Coupling Nuts - DIN 6334
- Jam Nuts - DIN 439B - ISO 4035
- Acorn Nuts - DIN 1587
- Serrated Flange Nuts - DIN 6923 - ISO 4161
- Smooth Flange Nuts - DIN 6923 - ISO 4161
- Nylon Inserts Locknuts - DIN 985
- Nylon Inserts Locknuts High - DIN 982
- All Metal Flange Locknut - DIN 6927
- Kep Nuts
- Washer - DIN 125A
- Washer - DIN 433
- Washer - Thick DIN 7349
- Fender Washer - DIN 9021B
- Helical Split Lockwasher - DIN 127
- All Threaded Rod - DIN 975
- Machine Screws - DIN 7985A/965A

New Item!
NOW CARRYING
(Made in **USA!**)



For more information visit our website @ www.stelfast.com

Service You Deserve...People You Trust

CLEVELAND
PH: 800-729-9779

ATLANTA
PH: 877-472-0033

CHICAGO
PH: 866-783-0161

DALLAS
PH: 866-783-5378

HOUSTON
PH: 800-473-1168

LOS ANGELES
PH: 800-581-8346

NEW JERSEY
PH: 800-506-6380

SEATTLE
PH: 844-783-5327

TORONTO
PH: 800-268-4723

MONTREAL
PH: 800-361-2155

GOEBEL FASTENERS INC.

5650 Guhn Rd Suite 110, Houston, Texas 77040

TEL 713-393-7007 FAX 713-393-7084 EMAIL sales@goebelfasteners.com WEB www.goebelfasteners.com



CELEBRATING 40 YEARS OF TOP QUALITY PRODUCTS AND SERVICE

Goebel Fasteners, Inc. is part of the Goebel Group which has been a family owned company for the last 40 years and built a reputation worldwide for its innovative fastener technology. Founded in 1979 by Brigitte Goebel and Klaus Arens, both recognized a need in the market for new fastener options that would turn the tide in industry. Now in its second generation many of the qualities that made Goebel successful in the beginning, such as providing customers with top quality products, competitive pricing, and exceptional service, remain core values of the company today. Originally it started as a local business serving the surrounding communities in Germany, the Goebel Group now has offices located in the United States, Germany, Netherlands, France, Poland, and Latin America. Specifically Goebel Fasteners, Inc. prides itself in strictly selling through a distribution based B2B model, offering the largest inventory of rivets, tapping screws, threaded inserts, and a full line of setting tools.

In Goebel Fasteners, Inc. continued efforts to maintain its reputation as “The Leading Rivet Source”, a new line of ratchet and cordless Lithium-Ion tools are set to release Fall 2018. The expansive lineup will include the GO-300 which has the capability to set up to M12 & ½” blind rivet nut threaded inserts; in addition

the GO-400 will also be released which is designed for the pin & collar products with the ability to set up to ¼” sizes in all material types. These two new cordless tools will be priced competitively and the user experience will be seamless as well as provide a unique alternative to the current hand tool lineup. Goebel Fasteners,

Inc. is committed to its distribution partners and invests continued resources into providing current marketing material that generates industry awareness; between informative articles, high-res product photos, as well as innovative 3D CAD video models, the company ensures that their products are backed by top quality content.

“Quality The First Time” is the motto that Goebel Fasteners, Inc. stands by; what the statement

articulates is that the customer should only have to buy the products they are looking for once and not twice due to a lesser quality product failing them. Goebel products are put through a rigorous QC testing process and the results are available as a courtesy to all customers by specific batch number. The Goebel Fasteners, Inc. team is committed to providing professional and knowledgeable service to each and every one of its customers.

In efforts to expand the company’s North American market share, Goebel Fasteners, Inc. has continually increased its stock inventory in Houston, TX as well as focused on developing new innovative tool products to improve industry efficiency. The company’s strategy is to not just carry a “me too” line of products, but to provide a level of quality and innovation that stands out among the rest.

If you are interested in being part of the next brand that revolutionizes the industry, make sure to contact Goebel Fasteners, Inc. today to see about their distribution opportunities. ●





The Leading Rivet Source

CALL US TODAY
713-393-7007



THE NEW GO-300

Lithium-Ion Cordless Threaded Insert Tool for Blind Rivet Nuts

- Set up to M12 & 1/2" Rivet Nut Inserts
- Interchangeable Power Packs
- Quick On/Off Threading Ability
- Various Mandrel Tips for All Sizes



RATCHET STYLE GO-12-P

Manual Pin & Collar Hand Tool

- Set up to 1/4" sizes in all material types
- Seamless User Experience
- Ergonomic Grips for Comfort & Safety
- Designed for a Variety of Lockbolt Products

COME
SEE US

International Fastener Expo,
October 30th – November 1st

AT BOOTH
3511



CONTACT US TO LEARN ABOUT AVAILABLE
DISTRIBUTION OPPORTUNITIES

IN STOCK AND READY TO SHIP FROM HOUSTON, TX

5650 Guhn Road
Suite 110
Houston, TX 77040

713-393-7007
goebelfasteners.com
sales@goebelfasteners.com



WOMEN IN THE FASTENER INDUSTRY

PO Box 242, Northvale, NJ 07647 EMAIL events@fastenerwomen.com WEB www.fastenerwomen.com

CALL FOR WOMEN IN THE FASTENER INDUSTRY VOLUNTEERS!

WIFI needs you! We have 9 amazing committees that are seeking volunteers.

▣ **Membership Development** - Are you interested in helping grow the WIFI network around North America? If so, this is the committee for you!

▣ **WIFI Support** - Are you interested in helping WIFI members learn the benefits of the WIFI network? If so, this is the committee for you!

▣ **Marketing** - Are you interested in helping with WIFI newsletters and press releases? If so, this is the committee for you!

▣ **Partnership** - Are you interested in working with WIFI's premier partners to increase the profile of WIFI across North America? If so, this is the committee for you!

▣ **Conference** - Are you interested in helping with WIFI conference and/or events to ensure it is a success,



with amazing speakers from all over the world, and all members of WIFI around the USA? If so, this is the committee for you!

▣ **Programming** - Are you interested in helping with WIFI's webinars? If so, this is the committee for you!

▣ **Virtual** - Are you interested in helping ensure WIFI's virtual members who don't have a event near them feel included within the WIFI network? If so, this is the committee for you!

▣ **Sponsorship** - Are you interested in helping raise funds for this much-deserved organization via our small business sponsorship, corporate sponsorship, webinar sponsorship, and conference sponsorship? If so, this is the committee for you!

If you are interested, please contact WIFI President Carrie Ann Whitworth at president@fastenerwomen.com.

ASSOCIATION ARTICLE

WOMEN IN THE FASTENER INDUSTRY

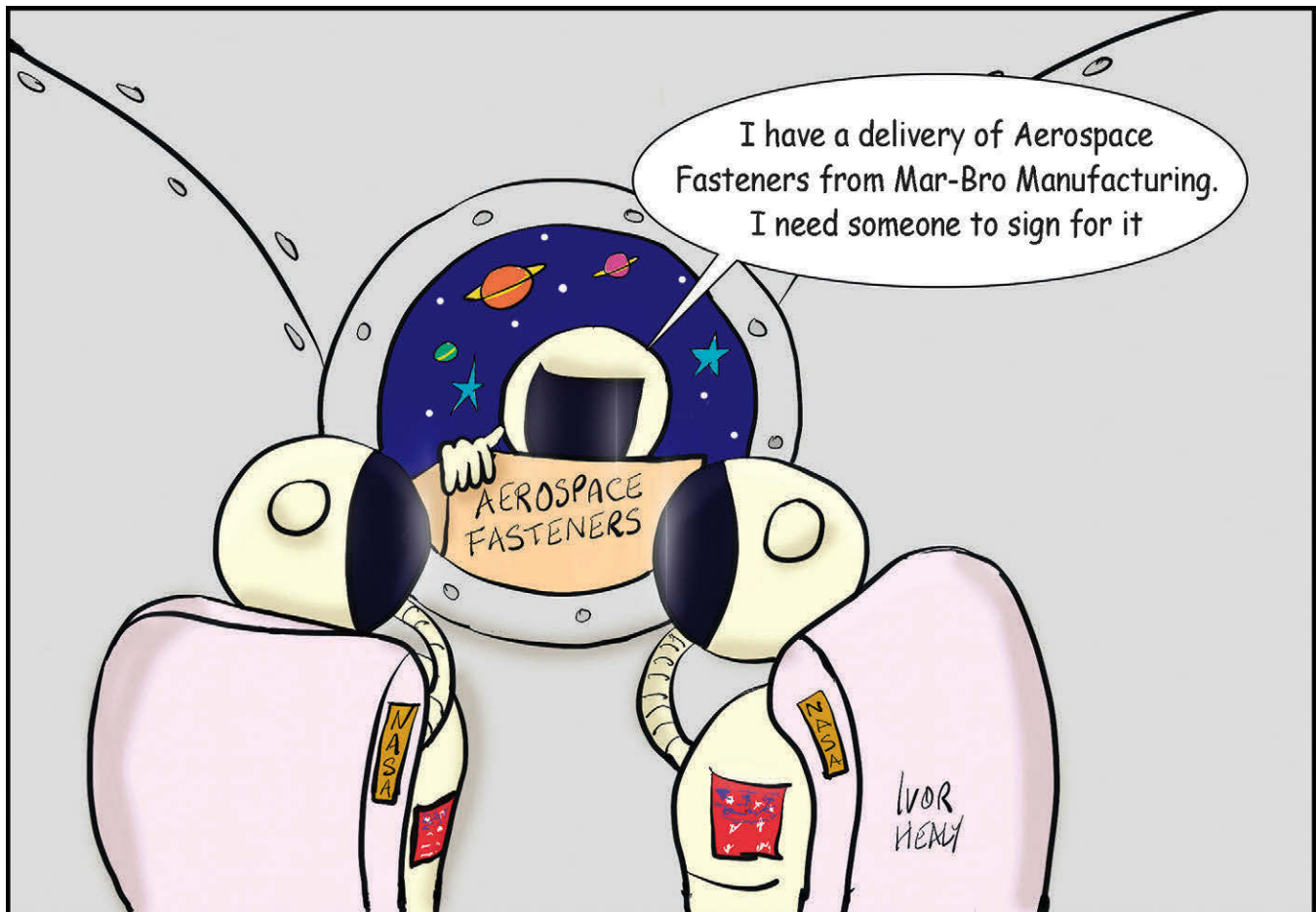

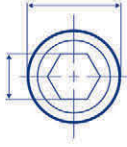

MAR-BRO
MANUFACTURING

A Fastener Company



Securing Your Success

Manufacturing Standards, Specials, MS and NAS Fasteners

Aerospace, Automotive, Military, Nuclear,
Oil and Gas Drilling, and Semiconductor

Diameters from #00 to 3/4"
(M1.0 to M19)

Lengths from .050" to 10"
(1.5mm to 254mm)

Specializing in A286

ISO/IEC 17025
Accredited Laboratory



CAGE CODE 54P83



For questions or to request a free quote, contact us at:
602.278.8197 or **sales@mar-bro.com** | **mar-bro.com**



Anthony Di Maio

Anthony E. Di Maio attended Wentworth Institute and Northeastern University. In 1962 he started working with Blind Fasteners as Vice-President of Engineering & Manufacturing for two blind rivet manufacturers. He has been Chairman of the Technical Committee of the Industrial Fasteners Institute (IFI) and is still involved in the writing of IFI specifications. In 1991, he started ADM Engineering and is working with Fastener Manufacturers developing new fasteners and special machinery. He can be reached at ADM Engineering, 6 Hermon Ave., Haverhill, MA 01832; phone and fax 978-521-0277; e-mail: tdimaio@verizon.net.

BLIND RIVET SPECIFICATIONS

In February 2003, the Industrial Fasteners Institute published the revised specification for Break Mandrel Open-End Blind rivets. I had the honor of being the Chairman of the Technical Committee during the time the Blind Rivet specifications were revised. Our purpose at that time was that we wanted to give the IFI specifications two very important technical information. First, dimensions with tolerances for all types of blind rivets in our specifications, to the extent, where a blind rivet manufacturer can state to their customers that their blind rivets are manufactured to IFI dimensional specification, and the user can dimensionally check the blind rivets at incoming inspections. Second, we wanted to show the Tensile and Shear values of all the types of blind rivets shown in the specifications. When we were updating the IFI-114 specification, we inserted a new design characteristic that did not exist before. The added characteristic is the .062 max. dimension between the mandrel head and the end of the rivet body.

I have been asked many times as to the meaning of the .062 max. dimension seeing that the .062 max. dimension is not a feature of either the mandrel or the rivet body.

The .062 max. dimension was added to the IFI-

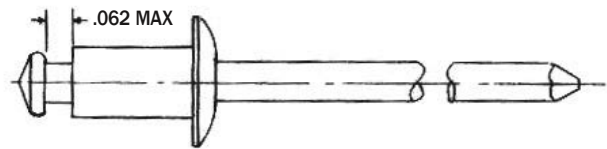

FIGURE 1

114 specification to draw attention to the assembly operation of the mandrel into the rivet body. The assembly operation drives the mandrel point into the rivet body by a mechanical means. Because of the tolerances of the length of the barrel, the mandrel head could contact the rivet body with a force large enough to expand the end of the rivet body, to the extent where the blind rivet will not enter the recommended hole size in the work piece. The .062 max. dimension allows the mandrel to be a distance from the end of the rivet body to ensure that the mandrel head will not contact and expand the rivet body.

The .062 max. dimension does not change the mandrel retention requirements between the rivet body and mandrel before setting the blind rivet. The assembled Open-End blind rivet should have mandrel and rivet body retention of at least 2.5lbs. The mandrel should not move in the rivet body when a force of 2.5 lbs. is applied to disassemble the blind rivet.

CONTINENTAL AERO™

A Division of TRAMEC, LLC

YOU CAN COUNT ON CONTINENTAL-AERO!

For over 70 years, Continental-Aero has set the benchmark for quality products & customer service above & beyond expectations. Let our expertise in secondary processes work for you.

One Purchase Order Turns Your Problems Into Solutions!

Continental-Aero...Experience you can trust, service you can count on!



866.419.5084 | CONTINENTAL-AERO.COM
ALSIP, IL | LYNDHURST, NJ | ARLINGTON, TX | CHINO, CA

Are You Tired of the
Secondary Process
RUN-AROUND?



**RELAX.
WE GOT
THIS!**

Custom & Specialty

FASTENERS by RUMCO

- 2-, 3-, 4-piece SEMS in stainless steel and various material assemblies
- Custom specials / captive fasteners
- Domestic full-line manufacturing



HEAVY TRUCK



MILITARY

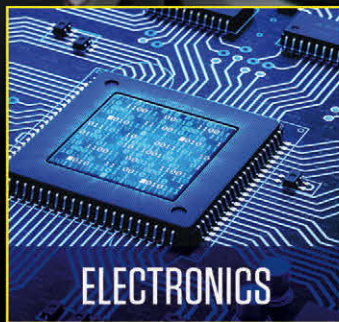

ELECTRONICS



MADE IN THE USA

We have your custom requirements covered.
Call (847) 364-5000 or email info@mw-ind.com

distributornews

PennEngineering® has obtained a \$14,000,000 judgment and permanent injunction against Dongguan Fenggang Pinconn Hardware Factory trading as "Pinconn," based on counterfeiting and infringement of more than 12 PennEngineering patents and trademarks. In addition to being permanently restrained from selling the infringing products and being ordered to remove the infringing content from its website, Pinconn was ordered to pay PennEngineering \$14,000,000 for statutory damages. The final order has been recorded with Customs to prevent importation to the U.S. of Pinconn products.

The complaint was filed against Pinconn on October 13, 2017, in response to Pinconn's appearance at the Las Vegas International Fasteners Expo, where PennEngineering enforced against Pinconn a Preliminary Injunction Order issued by the U.S. District Court for the Eastern District of Pennsylvania, resulting in the removal of all of Pinconn's signage, advertising materials, and infringing product at its trade show booth. The Preliminary Injunction also forced Pinconn to abandon its booth at the 2017 Design & Manufacturing Expo in Minneapolis.

PennEngineering will continue to enforce its intellectual property rights worldwide.

For more information, contact Michael J. Rossi, PennEngineering Tel: 215-766-8853, email: info@pemnet.com or at www.pemnet.com.



FASTENER ACADEMY

Make the connection. Learn the latest trends and technology in the world of Non-Threaded Fasteners.



YOU HAVE QUESTIONS, WE HAVE ANSWERS!
Our popular fastener training sessions can be conducted on-site or on-line, and can be as basic or as in-depth as you would like! Just contact us to learn more.

COMPLETE LINE OF NON-THREADED FASTENING SOLUTIONS

SLIC Pins™

U.S. Patent No. 6,872,039 & No. 7,147,420
Foreign Patents Issued

- Ideal for holes where cotter pin or retaining clip access is limited
- Rapid fastening speeds assembly by over 3X
- Easy, safe and fast



Rue Ring™ Locking Cotters

- Surrounds the shaft and locks on
- One of the safest cotters available
- Installs fast and easy without tools
- Our original proven design



Bow-Tie Locking Cotters™

U.S. Patent No. 6,135,693

- Works like a hair pin cotter but locks on
- Use in any hole location to ensure secure fastening
- Millions in proven use



Auto-Lock Safety Pull Pin

U.S. Patent No. 8,821,061

- Retractable tip locks into an extended (forward) position automatically
- Will not disengage until ring is pulled



Nylon Lanyards™

- An inexpensive tether
- Many styles and lengths
- Durable 6/6 nylon



PLUS SO MUCH MORE!



PIVOTPOINT^{INC.}

PINS > CABLES > SOLUTIONS

A Family Owned Manufacturer • Hustisford, WI

www.pivotpins.com

VISIT US IN VEGAS! FASTENER SHOW BOOTH #3046

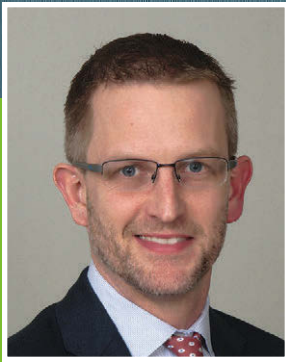

Derek Dandy

Market Development Engineer

BODYCOTE S³P

443 East High Street, London, OH 43140

TEL 740-852-4955 FAX 740-852-4956

EMAIL Kolsterising.London@bodycote.com WEB www.bodycote.com/s3p

BOLTED JOINT CONSISTENCY WITH STAINLESS STEEL FASTENERS

Abstract

Bolted joint design can be a challenging task when faced with the number of factors that lead to a safe and reliable joint. Failure to understand these factors can be catastrophic if proper attention is not given to each and every component in the joint. In this article we will discuss an approach to minimize fluctuations with respect to coefficient of friction when using stainless steel as well as nickel- and cobalt-based fasteners.

Introduction

As is well known in the fastener industry, ~90% of installation torque can be lost to friction under the head of the fastener and in the threads. Due to the fact that this percentage is so high, minimizing any variation with fastener behavior can have a significant impact on the consistency of the clamp load generated in the joint. The dimensionless number that dictates the friction is commonly referred to as Coefficient of Friction (CoF). It is not uncommon for the CoF to be given as a range of values, ex. .38-.42. These given CoF values are initial values and do not take into account surface degradation from adhesive wear, commonly known as galling, that occurs with multiple installs. The relationship between CoF and clamp load is explained using the formula:

$$T = k d F$$

where T = input torque, k = Coefficient of Friction,
 d = nominal fastener diameter and F = Clamp load

Using the example values of .38-.42 for CoF mentioned above, there can be up to a 10% difference in the joint clamp load. In an ideal installation, a complex piece of equipment can be used to measure clamp load at each and every fastener, this can be costly and time prohibitive. In order to eliminate CoF variation it is very common to use other methods such as field applied lubricants, or pre-applied waxes or dry films lubricants. This can create other variables such as how much of the lubricant should be used, what type of lubricant should be used, etc.

So far we've only discussed initial fastener use but in many cases fasteners are reused as a cost savings measure. In other cases, with more exotic materials, reuse would be a great cost advantage but many of these joints are so critical in nature that replacing the fasteners is mandated as part of a preventative maintenance schedule.

Bodycote, the world's leader in thermal processing services, has just the solution to these common threaded fastener issues. Kolsterising®, part of the Specialty Stainless Steel Processes (S3P) group within Bodycote, has been shown to eliminate the above mentioned issues with respect to CoF. Kolsterising® is a low temperature carbon-based diffusion process that increases the surface hardness up to 1200HV0.05 (~72 HRC). This hardened layer has a gradual profile allowing the surface to retain its ductility with no risk of embrittlement. As opposed to some other high temperature processes, this hardened layer is part of the base material therefore there is no risk of cracking, chipping or delamination.

E&T FASTENERS

INDUSTRIAL FASTENERS & COMPONENTS

YOUR METRIC & STANDARD FASTENER & ACCESSORY SPECIALISTS

Screws & Bolts
Threaded Rod
Glass Filled Isoplast Flange Nuts
Nuts
Washers & Shoulder Washers
Screw Insulators & Spacers
Clear Binding Posts & Screws
Bumpers & Rubber Feet
Quick Binding Hardware
Circuit Board Hardware
Hose Clamps & Installation Tools
Panel Fasteners & Hole Plugs
Press-Loc Thumb Screw Knobs
Wire Handling Hardware
Wiring Accessories & Cable Ties
Xmas Tree Clips, Plugs & Bushings
Isoplast Hex Head Cap Screws

PLASTIC FASTENERS & COMPONENTS

PLASTIC MATERIALS

METAL MACHINED FASTENERS

E&T Fasteners takes pride in offering exceptional service, remarkable pricing and lead times that can't be beat. Our staff has extensive experience in the plastic fastener and component industry. Need technical assistance? We can help. We're committed to being on the cutting edge of what's new in the industry so you'll never deal with an inexperienced clerk.

With networked fastener operations in California and North Carolina to serve you, we're there when you need us regardless of where you placed your plastic fastener or plastic component order.

E&T Fasteners offers a complete line of engineered molded plastic fasteners and machined metal fasteners.

E&T can machine precision custom plastics fasteners and metal components to your specifications. Don't have a drawing? In most cases we can create a drawing from your sample. Every person on our engineering staff is committed to delivering you with the highest quality metal or plastic fastener and component product in record time.

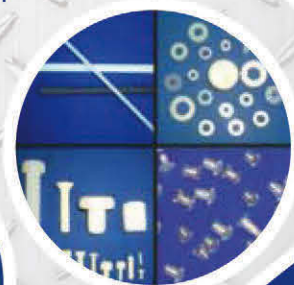

EASTERN US: (800) 650-4707
WESTERN US: (800) 732-0530

www.fastenercomponents.com

EASTERN US

41 Odell School Rd, Unit A
Concord, NC 28027
Tel: (704) 933-5774
Fax: (704) 933-5775
eric@fastenercomponents.com

WESTERN US

14360 Lakeshore Drive
Clearlake, CA 95422
Tel: (707) 995-2955
Fax: (707) 995-2994
hope@fastenercomponents.com

PENN ENGINEERING

5190 Old Easton Road, Danboro, PA 18916

TEL 1-800-237-4736 FAX 215-766-0143 EMAIL info@pemnet.com WEB www.pemnet.com

PennEngineering®

SURFACE MOUNT FASTENERS FOR PRINTED CIRCUIT BOARDS by Michael J. Rossi, Marketing Services Supervisor

Surface mount fastening technology has come a long way in recent years with increasingly more fastener types and functions. Regardless of type, surface mount fasteners install permanently onto a printed circuit board by employing existing production infrastructure. By surface mounting a fastener to a board, significant cost savings can be achieved without compromising the performance of a design.

Such fasteners fed on a tape and reel, assembled with pick and place equipment, and reflowed alongside other electronic components ultimately offer the potential to save handling time and money and reduce the possibility of board quality failures, which sometimes can occur as an offshoot of working with other kinds of hardware.

The hardware – supplied on tape and reel consistent with SMT automated installation equipment – is positioned where designed while a board is being processed and then permanently installed with pick-and-place robotics in the same manner and at the same time as other surface mount components prior to the automated reflow solder process. The fasteners simply become another non-intrusive component on a board. And since the parts are packaged on a tape and reel (neither loose nor dumped into bowls), there is no chance of inadvertently mixing the parts with other hardware.

The portfolio of surface mount fasteners is growing and many types and styles have been engineered, each serving one or multiple purposes. Depending on type, surface mount fasteners can be specified to mount,

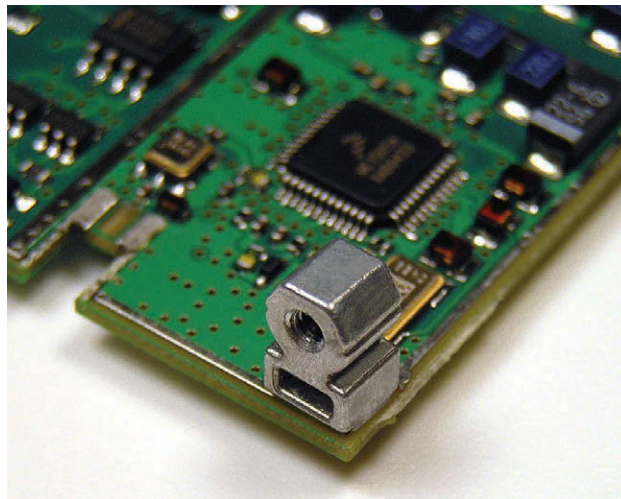

SURFACE MOUNT FASTENER SOLUTIONS FOR PRINTED CIRCUIT BOARDS INCLUDE RIGHT-ANGLE VERSIONS CREATING PERMANENT RIGHT-ANGLE ATTACHMENT POINTS.

stack, or space boards; attach components to boards; or create right-angle attachment points on boards. Some integrate captive screws – eliminating loose screws and all the related hassles – ideally suiting applications where removal and reinstallation of boards is anticipated.

Surface Mount Spacers, Nuts and Standoffs

These threaded or unthreaded types offer the capabilities to stack, space, and/or attach and can be installed in boards as thin as .020" / 0.5mm. Reels carry up to 3,500 parts, depending on fastener size. A polyimide patch is supplied to allow for reliable vacuum pickup. Fasteners are also available without a patch, which may provide a lower-cost alternative, depending on installation methods/requirements. Fasteners are available either in brass or steel.



CHICAGO HARDWARE & FIXTURE COMPANY

9100 Parklane Avenue, Franklin Park, IL 60131

TEL 847-455-6609 EMAIL info@chicagohardware.com WEB www.chicagohardware.com

DOMESTIC MANUFACTURER OF STEEL WIRE FORM FASTENERS & DROP FORGED PRODUCTS

Chicago Hardware & Fixture Co., founded in 1912, is a domestic manufacturer of steel wire form fasteners and drop forged products used in the rigging industry. Since our founding over 100 years ago, our three Chicago-area manufacturing facilities have been supplying high quality domestically manufactured product to markets served by the fastener and rigging industries. The commitment to provide USA manufactured products extends back to USA Made and Melt Steel. Certification of Made and Melt products can be provided upon request at time of order.

Chicago Hardware & Fixture is proud to be "Made in the USA, providing products to users in the following markets: General Construction, Infrastructure Construction, Petrochemical and Refinery Construction, Industrial Manufacturing, Steel Fabrication, Mining, Power Transmission, Agriculture, Marine and Transportation.

Formed Wire & Fastener Products

- ▣ U-Bolts-Standard and Long Tangent
- ▣ Turned Eye Bolts & S-hooks
- ▣ Threaded Rod
- ▣ Malleable Wire Rope Clips and Thimbles

Forged Products

- ▣ Machinery Eye Bolts
- ▣ Metric Eye Bolts
- ▣ Pad Eyes
- ▣ Hooks
- ▣ Wire Rope Clips
- ▣ Turnbuckles
- ▣ Eye Nuts
- ▣ Swivels
- ▣ Rod Ends
- ▣ Shackles

We offer our products in a variety of finishes and materials. We also offer special products to your specifications. Our products are stocked at strategically located warehouse facilities across the USA to immediately service your customers' needs. 

BUSINESS FOCUS ARTICLE

CHICAGO HARDWARE & FIXTURE CO.

Chicago Hardware & Fixture Co.
"Manufacturing Only in America for over 100 Years"

chicagohardware.com

Family Owned
Superior Quality

QUALITY SYSTEM CERTIFICATION
ISO 9001:2008
DNV

MGMT. SYS.
RVA C024

EFC INTERNATIONAL

1940 Craigshire Road, St. Louis, MO 63146

TEL 1-800-888-3326

EMAIL info@efc-intl.com

WEB www.efc-intl.com



THE EFC DIFFERENCE

EFC's culture of collaboration and innovation permeates all aspects of the company and its operations. Unprecedented levels of solution-based products and services are provided with focus on six key attributes: Global Presence-Local Support, Engineering, Quality, Connections, Logistics and Expert People.

Through a robust globalization strategy, EFC has mirrored their supply chain on multiple continents with a physical presence in the USA, Canada, Mexico, China, South Korea, and Germany. Developing an invaluable team of international employees, EFC delivers an unbeatable customer experience globally.

EFC offers one of the world's widest ranges of engineered fasteners including, but not limited to stamped and assembled components, self-retaining nuts, panel fasteners, specialty screws, nuts, bolts, caps, handles, plugs, hose clamps, electrical and routing components. We offer the customer direct access to premier branded products and supplier consolidation. EFC engineers and technical product specialists use their extensive knowledge and collaborative approach to select or design a fastener (metal, plastic or combination) that will meet the application requirement and optimize the ergonomic factors of the solution; they do it quickly and economically.

Customers' unique needs and requirements are met with EFC's customized inventory programs with the flexibility to adapt. Product solutions, combined with logistic solutions tailored to the customer, streamline customer operations, and mitigate supply chain risks while enhancing their end-product quality and reducing total costs.

EFC's dedication to quality incorporates ISO 9001:2015 certification, peerless manufacturing partners, SAP-CRM, and fully automated warehousing processes working together to assure the highest quality, in both products and service. We use technology to achieve competitive advantage, and we pursue strategies based on best practices to differentiate us from our competitors.

Our commitment to providing engineered solutions for the automotive, industrial, and distribution markets throughout the globe is evident. EFC's physical presence



EFC USA WORKING TOGETHER WITH EFC KOREA TEAM MEMBERS WHILE IN KOREA RECENTLY.

globally enhances relations, provides local support and value by offering a simpler, more cost-efficient way to manage the supply chain. The international growth is a tribute to the EFC team and to the strong international reputation of their partnerships with world-class manufacturers.

World-Class, Premier, Expert, Best, Unprecedented, First-Class - the use of these words in promotional materials, advertising, website, and videos mean nothing unless the customer experience has been associated with it.

"Your employees are absolutely the best people I deal with out of my 39 primary suppliers. They understand urgency.... You have an awesome team and they are a pleasure to work with."

"The way you control your inventory, (SAP and Barcoding) and the way you monitor your processes, (Metrics Data) are second to none....the reason you (EFC) are where you are today."

"I just wanted to complement your company's performance to date in response times and the "taking care of the customer" aspect of the automotive industry..... Your team epitomizes the definition of great service..."

Expanding the global footprint and investing in key global markets and people, EFC ensures both supplier and customer needs are met with the high-quality service they've come to expect from EFC – anywhere in the world. ○

EFC

INTERNATIONAL™

REDEFINING
THE WORLD
OF DISTRIBUTION™

CONNECTIONS

EXPERT
PEOPLE

ENGINEERING

QUALITY

LOCAL
SUPPORT
GLOBAL
PRESENCE

LOGISTICS

Stay Connected With The World's Most Innovative Fastening Solutions

EFC International Is A Global Provider Of Specialty Engineered
Metal, Plastic & Electrical Fastener Components
Including Design & Application Engineering
ISO 9001:2015 Certified

ARaymond® TW ATLAS CETIKER AVK Sembler NORMA GROUP PSM International SPIROL Camloc HEYCO STANLEY



EFC-INTL.COM | +1 314.434.2888

ATLANTA • ST. LOUIS • CHICAGO • DALLAS • DETROIT • FRANKFURT • TORONTO • QUERÉTARO • SHANGHAI • SEOUL

METROPOLITAN FASTENER DISTRIBUTORS ASSOCIATION

PO Box 72, Lake Zurich, IL 60047

TEL 201-254-7784 FAX 847-516-6728 EMAIL admin@mfd.us WEB www.mfda.us

MFDA AWARDS 2018 SCHOLARSHIPS

by Nancy Rich

On June 14th the MFDA held their annual scholarship meeting recognizing this year's scholarship recipients. MFDA offers scholarships, annual, to members' children entering college. Congratulations to this year's winners:

Board of Directors Scholarship \$2,500

Caitlin Rundle daughter of Rob Rundle of R.W. Rundle Associates.

\$2,000 Tanzman Family Scholarship

Jennifer Grohowski daughter of Linda Grohowski of Brighton Best International

\$1,750 ND Industries Scholarship

Tapia - Ramos daughter of Jose Tapia of Weinstock Bros.

\$1,500 Bob Rundle Memorial Scholarship

James J. Meiman son of James H. Meiman of Kanebridge Corp.

\$1,000 Star Stainless Screw Scholarship

John Insinga son of Leigh Ann Sherow-Insinga of ND Industries

\$1,000 Metric & Multistandard Components Scholarship

Kinsleigh Edmunds daughter of Duwayne Edmunds of Brighton Best International

\$750 Yellow Woods Scholarship

Valeria Cantillo daughter of Misael Cantillo of Captive Fasteners

\$750 MFDA Scholarships

Morgan Stover daughter of Joanne Stover of Ken Forging



Vanessa Cantillo Daughter of Misael Cantillo of Captive Fasteners

Brianna Pearson Daughter of Deborah Pearson of Brighton Best International

Thank You To Our Door Prizes Sponsors

Brighton Best International
Star Stainless
Yellow Woods
R.W. Rundle Associates
MF Supply
Raw Products

Thank you also to Barb Traum for heading up the Scholarship Committee and coordinating this event.

MFDA New Members

Accurate Components Corp - West Babylon, NY
InterCorp - Fairfield, NJ
Elgin Fastener Group - Brecksville, OH
Rick Rudolph Associates, LLC - Melrose, MA 

GET THE 'ALL METAL'

LOCKNUT

Advantage

Choosing the right locknut supplier requires some understanding of these unique products, with their very specific technical requirements. At Locknut, 'all-metal prevailing locknuts' is all we do - so, why would you trust some product from an unknown source, questionable quality or untraceable manufacturer, due to a lack of proper head-marking? Here's why you can trust us...

THE 10 ADVANTAGES OF LOCKNUT TECHNOLOGY

- 1 TECHNOLOGY DRIVEN
- 2 MADE IN THE USA
- 3 HIGH QUALITY BLANKS
- 4 PRODUCT VARIETY
- 5 LARGE INVENTORY
- 6 STANDARDS COMPLIANCE
- 7 PROTECTION & PLATING
- 8 ON-SITE TOOL ROOM
- 9 ISO 9001:2015
- 10 ENGINEERING SUPPORT

Locknut Technology Inc - where quality is the priority.

351 South Lombard Road, Addison, Illinois 60101 Tel: 630-628-5330 Fax: 630-628-5331

Email: sales@locknuttechnology.com Web: www.locknuttechnology.com

LOCKNUT
TECHNOLOGY INC.

OUR NAME SAYS IT ALL



THREADS

- ACME
- LEFT HAND
- LAG

TO GO

SOCKET HEAD

- ASTM A 193 B7
- ASTM A 193 B16
- ASTM A 193 B8
- ASTM A 193 B8M

CAP SCREWS

ASTM

- L7
- B8 CLASS 1
- B8 CLASS 2
- B8M CLASS 1
- B8M CLASS 2

A320

METRIC

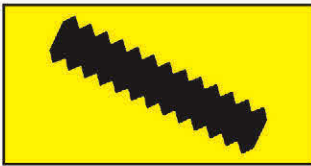

THREADS

SAME DAY

STUD BOLT
MANUFACTURING

SERVICE

SPECIALTY

DOUBLE
END
STUDS

STEELS

QUICK

HASTELLOY
AND
TITANIUM
BOLTING

DELIVERY

BIG enough to SERVE.

BOLTS-STUDS

STRAIN HARDENED
STAINLESS
STEEL

NUTS

STOCKED

304 ELC
316 ELC
317 ELC

LARGEST STOCK OF
BOLTS & NUTS AROUND!

VARIETY

17-4 PH
DUPLEX 2205
904 L
NITRONIC 60
INCONEL 600

BOLTS & STUDS

THINK

BIG
STEEL

MANUFACTURING

BOLTING

ALLOY 20

SHIPPED DIRECT FROM
STOCK & MADE TO ORDER!

HOT DEALS

ASTM A453
GR. 660

MANUFACTURED FOR STOCK
AND MADE TO ORDER

AROUND THE CLOCK

- BREAK DOWNS
- EMERGENCIES
- TURNAROUNDS

"SPEEDY"
BOLT SERVICE

SUPER

HIGH
TEMPERATURE
BOLTING

ALLOYS

YOU CHOOSE

310
321
347

MANUFACTURED FOR STOCK
AND MADE TO ORDER

ASTM

• 2H • 6F • 8A • 8M
• 3 • 7 • 8SH • 8MA
• 4 • 7M • 8C • 8MSH
• 6 • 8 • 8F • 8T

A194

QUALITY

MONEL K MONEL

YOUR SPECIALS
ARE OUR STANDARDS!

THREADED

SPECIAL LENGTHS

RODS

PREMIUM

QUICK
HEX BOLT
MANUFACTURING

SERVICE

HEAVY HEX

ASTM A194 8A
ASTM A194 8MA

NUTS

ASTM

• B16 • B7 • B8 CL.1
• B8C • B6 • B8 CL.2
• B8T • B5 • B8M CL.1
• B7M • B8M CL.2

A193

HOT

CUSTOM FORGED

HEADS

small enough to CARE. →→→

ASTM

• A193
• A194
• A320

BOLTING

CONTINUOUS

RODS STUDS

WRINKLES

STAINLESS

UP TO
50 FOOT
LENGTH

TIE RODS

WE BEND

DIMENSIONS
PER IFI
OR PRINT

TO PLEASE

LONG

18-8
316

BOLTS

FLAT

• 310 • 410
• 316 ELC • A20
• 321 • A400
• SPECIALS

WASHERS

12 POINTS



FORGED

ALWAYS



ON CALL

**Bolts • Nuts • Studs
Sockets • Washers
Bent Bolts**



**ALLOY &
STAINLESS
FASTENERS**

On Call 24-7 for

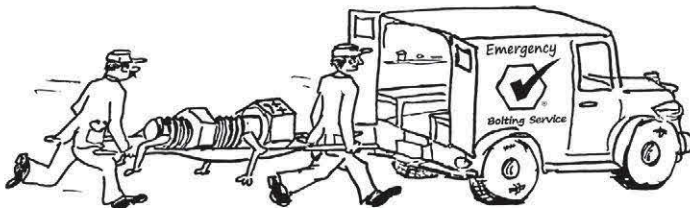

BOLTING EMERGENCY

**Special Metals and Alloys
Over 150 Material Grades
Over 25 Coatings and Platings
Over 250 Machines
10,000 Ton Inventory
Future Stock Programs
Serving Resale Distributors
We Service All Quantities**

www.GoASF.com

distributornews

Semblex Corporation

is commemorating its 50th anniversary this year. Founded in October of 1968, in Elmhurst, IL, Semblex's history spans five decades as a world class fastener manufacturer. The celebration will culminate with several events this October to celebrate with employees, retirees, customers, suppliers, and other key individuals that have had a stake in the company's success.

Since 1968, manufacturers have gone to Semblex to find the highest quality fastener products and the latest fastening technologies available, along with expert fastening support from the technical resources within the company.

Semblex readily shares state-of-the-art knowledge with their customers through their Fastener Basics training program and customer "Tech Day" events. This expertise provides their customers with a greater assurance that they will assemble their products with optimum efficiency and quality while at the lowest possible overall cost.

While Semblex's services and operations have expanded over the years, the company's underlying principles of quality, family & customer focus have remained constant. Semblex is proud to celebrate their 50-year milestone and looks forward to the next 50 years!

For more information, contact Semblex Corporation by Tel: 1-800-323-1736, Fax: 630-530-8189, Email: sales@semblex.com or visit their website at www.semblex.com.

distributornews

Sherex Fastening Solutions, is pleased to announce that their Sherex Taiwan production facility has received IATF 16949:2016 certification.

To gain accreditation, businesses must possess quality systems that focus on continuous improvement to prevent defects, and eliminate high variation and waste throughout the supply chain.

“Since its inception in 2005, Sherex Taiwan, led by Dr. Alex Hsiao, has provided industry-leading new product development and manufacturing utilizing robust quality systems,” says President Adam Pratt, “we are excited to see our efforts acknowledged through the IATF accreditation.”

Sherex Fastening Solutions and Disc-Lock provide fastening solutions for thin sheet material attachments and vibrational loosening prevention. We offer standard and custom solutions, combining fasteners, tooling, and automation to deliver the best solution at the lowest total installed cost. With locations in the USA, Mexico, and Taiwan, Sherex and Disc-Lock products are manufactured to the highest quality standards. Sherex products are used in Automotive, Aerospace and Defense, Agriculture and Construction Equipment, General Industrial, Rail, and Heavy Truck markets.

For additional information contact Sherex Fastening Solutions, LLC at 400 Riverwalk Pkwy, Suite 600, Tonawanda, NY 14150. Tel: 1-866-474-3739 or visit them online at www.sherex.com.

CUSTOM MANUFACTURED FASTENERS



CAVALIER

Industrial Specialties



**Our Manufacturing Processes
include Forging, Turning,
Milling, Drilling, Slotting,
Broaching, Grinding,
and Roll Threading**

**ISO 9001:2015
ANSI • DIN • MIL-DTL-1222J
Tri-Roll Gaging**

Sales@GoCAV.com

Ph: 713-983-0055

Fax: 713-983-0058

BAR STOCK SPECIALTIES, INC.

11710 Charles Road
Houston, TX 77041
Phone: 713-849-0055
Fax: 713-466-3583
Email: info@GoBarStock.com
Web: www.GoBarStock.com

METAL BAR

DRAWING
PEELING
GRINDING
CUTTING

PROCESSING

HAVE A ROUND

• B16	• 316	• 347
• 304	• 316 ELC	• 410
• 304 ELC	• 316 SH	• 501
• 304 SH	• 317 ELC	• A20
• 310	• 321	• A400

FROM US
(ROUND BAR THAT IS)

LONG LENGTH

UP TO
60 FOOT

STAINLESS BAR

distributornews

Phillips innovations are used by a variety of industries, including aerospace, automotive, and heavy industry. Technology developed by Phillips can be found on jet engines and floor boards of commercial aircraft, transmissions and engines of cars, and even the windshield of the space shuttle. Having an experienced engineering staff is important to the long-term success of Phillips.

"We are forecasting the next ten years to be a boom time for us in terms of fastener growth." Hurley went on to say, "There is a lot of opportunity, but I don't ever want to take that for granted. I look to our team to continue to innovate and Gary will be a key part of our future."

Phillips latest innovations are Lightning™ Deck Screws and Lightning™ High-Performance Wood Screws. These products are currently being introduced into the North American lumber and DIY markets. In addition, Phillips has had equal levels of innovations in their U.K. division with multiple introductions of Bullet® and Ulti-Mate® branded screws. Gary Dilling took a lead role in the development of all of these items and continues in his research and development of further innovations.

For more information, contact Todd Ruehs at The Phillips Screw Company by Tel: 781.213.3501, Email: truehs@phillips-screw.com or at www.phillips-screw.com.

distributornews

The Phillips Screw Company announces the promotion of Gary Dilling to the position of Director of Engineering.

The Phillips Screw Company has been a leader in the fastener industry with their patented drive systems and thread innovations. In order to remain the leader and to continue serving the industry with award winning designs, Phillips has appointed Gary Dilling as the Director of Engineering. Gary has served as a Fastener Engineer at Phillips since 2002.

Gary Dilling has served as lead engineer at The Phillips Screw Company for 16 years.

In order to continue as the market leader in innovation, a new

role of Director of Engineering has been created.

Gary Dilling will be the Director of Engineering and lead Phillips in new product and intellectual property development.

According to Ken Hurley, CEO for The Phillips Screw Company, "The lifeblood of any growth company is new products and services. What keeps me up at night, is how we continue to keep the pipeline of innovation full. Gary is the right



guy to lead our innovation and new product development process. He is a long-standing employee who continues to come up with key innovations and we believe he will help us accelerate at an even faster rate in this new position."



ASTM F467/F468/MIL-DTL-1222J/MIL-S-1222H3/FF-S-86E
MS17828/MS17830



IDEAL SUPPLY, INC.

New Corporate Office
11400 Kreuzer Road • Huntley, IL 60142

Virginia Office
624 Innovation Dr., Suite 101 • Chesapeake, VA 23320

ILLINOIS

Ph. 847.961.5900

Fx. 847.961.5300

Email: idealsupply@idealsupplyonline.net

VIRGINIA

Ph. 757.548.8050

Fx. 757.548.8051

Email: vasales@idealsupplyonline.net

FASTENERS

MONEL 400, K500

SILICON BRONZE

651, 655

STAINLESS STEEL

304 & 316

DOMESTIC/DFAR COMPLIANT

www.idealsupplyonline.net

ASTM B164/QQ-N-281 D2/QQ-N-286 F&G/INCONEL 625/718

*** Domestic Monel 400 & 500/304 & 316SS/Naval Brass 464 Nuts ***

For Hex Head Caps, Socket Cap Screws, Set Screws, Flat Sockets, Machine Screws, Finished Nuts, Heavy Nuts, Jam Nuts, Flat Washers, Lock Washers, Nylon Insert L/N, Studs and Threaded Rod all to Industry Specifications.

MONEL® — Trademark of Inco Alloys

What is Johan Smit Fasteners?

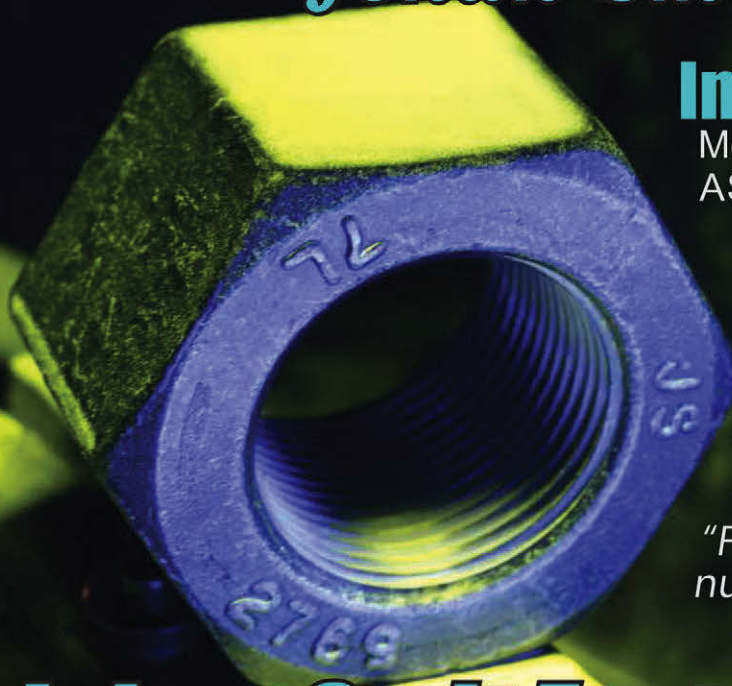

Inventory

Metric and Imperial

ASTM A194 - Full Range

Quality

140 Years of Expertise

ISO 9001:2015

PED 2014/68/EU

Traceability

"From the melt to the joint,
nuts that are always traceable"

Johan Smit Fasteners

www.johsmit.com - info@johsmit.com



MARTIN SUPPLY

125 North Court Street, Florence, AL 35630

TEL 1-800-828-8116 FAX 256-389-3436 EMAIL callcenter@martinsupply.com WEB www.martinsupply.com



MARTIN DEVELOPS INNOVATIVE ONLINE QUOTING TOOL

by Anthony Crawl, Director of Sales

Martin Supply, a leading distributor of MRO and Fastening products, has been helping customers operate better since 1934. We do that by providing custom tailored solutions that focus on three things: Cost Elimination, Increased Productivity, and Asset Management.

To help increase productivity, we have developed an exciting new quoting tool for our website. Far too often our customers are out on the plant floor and need a part quoted. It is too loud to make a phone call, so they have had to write down the model number, manufacturer, and any other info they can find. Then they go back to their desk, find their salesman's contact info, and type it all back into an email and submit it to be quoted.

Martin has cut those steps down so that work can easily be done out on the floor.

- Our mobile responsive website, MartinSupply.com, has the Quick Quote feature embedded at the top of the home page.

- In the quoting module customers put how they would like to receive their quote. After completing it the first time the site saves your info, making subsequent uses even easier.

- Then, customers can either type in their request or they can take a picture of what they need.

- The picture can be taken directly from the module, and automatically attaches to the quote.

- Our Customer Service team quickly identifies the product and promptly get a quote back to their email. By enabling our customers to handle problems on the go we have taken the hassle out of sourcing, because we understand that time is our customer's most valuable

Get Savings in a Snap with

 QUICK QUOTE

at MartinSupply.com

IT'S AS EASY AS
SNAP & SAVE

Send us your product information or an image of what you need and our Customer Service Team will quickly get you a quote.



MARTIN
MartinSupply.com | 800.828.8116

asset. They need a supply chain partner that they can trust. So next time you need an item quoted go to martinsupply.com and get Savings in a Snap! 



Anthony Crawl is the Director of Sales for Martin Fastening Solutions, a global sourcing and supply chain management company specializing in off the shelf class "C" components and per print specials. To contact Anthony you can email him at Anthony.Crawl@MartinFastening.com.



Can you tell
which bolt isn't

Hard?

We Can!

Our high speed eddy current system now integrates with all of our machinery to give you the ability to verify that each and every part went through the heat treat process.

ADAPTIVE[™]
eddy current

Attica
Automation
www.atticaautomation.com

BRIGHTON-BEST INTERNATIONAL

USA Headquarters, 5855 Obispo Avenue, Long Beach, CA 90805

TEL 562-808-8000

FAX 562-808-8137

EMAIL sales@brightonbest.com

WEB www.brightonbest.com



BRIGHTON-BEST INTERNATIONAL

BRIGHTON-BEST'S PEOPLE & PLACES



Both Peggy and Jun are honored to receive the 2018 Young Fastener Professional of the Year Award. As young professionals, it means the road in front of us is longer than the road behind us.



They encourage all young professionals in the fastener industry to be curious, ask questions, and grow. Because the only thing certain about our future is change. "It is imperative for professionals in our industry to develop themselves and

their skillsets so that they are able to frame this future rather than adapt to it."

Brighton-Best International has been awarded the 2018 Growth Champion Industrial Trade and tools Award at the National Conference in Australia courtesy of Hardware and Building Traders (HBT).



BBI was also awarded the 2017 Supplier Excellence Award courtesy of Distributor Partnership of America (DPA)

BBI is pleased to introduce Mr. Arthur Bernardon as the newest member of the BBI organization, Arthur (Artie) will be working in the Preferred US Anchor Product Division as the new Preferred US Anchor Business Development Manager. Artie comes to BBI from a stellar career as VP of Powers Fastener Company working in the capacity of purchasing,



marketing, key accounts. He brings a wealth of industry experience. Artie is extremely pleased to have this opportunity to work in our dynamic environment with accelerated growth.

Brighton-Best International is pleased to announce that it's Preferred US Anchor division has received the Miami Dade County approval for its flagship anchor – Ultrawedge+. This approval covers Cracked and Un-cracked concrete to include high velocity, corrosion and State of Florida recognition.

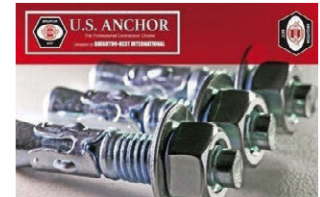

BBI Q.A. lab in Santa Fe Springs, CA has been approved for continued accreditation by the American Association for Laboratory Accreditation (A2LA) until 2020.

Cleveland's new 209,000 sq ft BBI distribution center is scheduled to open on November 30th, 2018. The new address will be Brighton Best International 21855 Commerce Pkwy, Strongsville, Ohio 44149 and customers can expect to pick up at the new location starting Monday December 3rd, 2018.



We are celebrating the opening of Ironclad Headquarters at their new location in 3325 Roy Orr Blvd Suite #200, Grand Prairie, Texas 75050. Customers are welcome to visit any of our locations and tour the warehouses facilities. 



distributornews

EFC International, is pleased to announce its team expansion in targeted regions and markets, including Autonomous Vehicles, Electric Vehicles, and Industrial markets.

Shanghai EFC Fasteners Col. Ltd. added seven team members: Director of Sales, Zhanchun Gu; Tina Li, Buyer; Dan Gong, Sales Engineer; Inside Sales Account Managers, Sunny Li, Gloria Shen, and Seven Shen; Logistics Coordinator, Carina Liang. Their collaboration with the existing EFC team, customers and suppliers within China has been significant to growth.

EFC International Korea welcomes Sales Engineer, Daniel Kim. Daniel brings a wide range of experience and insight to his position and has the initiative to achieve results.

Alan Ibarra joins EFC Global S de RL de CV in Queretaro, Mexico as Account Manager for Inside Sales. Alan joins EFC with a vast knowledge of the industry and is a valuable addition to the team in Mexico.

Guenter Retkowski, VP of International Sales states, "The new hires are vital to EFC's strategic development of international opportunities. Each individual brings experience within their respective roles and are key in global business growth. They are a sign of our commitment to continue as a leader in our industry. They will make a beneficial impact, as well as, enrich our customer and supplier partnerships."

For more information contact EFC International by Tel: 314-434-2888 or visit the website at www.efc-intl.com.

FASTAR



dowel pins

ASME B18.8.2	MS9390
MS16555	M21143/1
MS16556	M21143/2
MS9105	



coiled pins

ASME B18.8.2	MS51923
ASME B18.8.3M	MS51987
ISO 8748, 8750, 8751	NAS1407
MS39086	NAS561



slotted pins

ASME B18.8.2	ISO 8752
ASME B18.8.4M	MS16562
MS171431-171790	NAS561



grooved pins

MS35671	MS35672
MS35674	MS35675
MS35677	MS35678
MS51605	MS51606

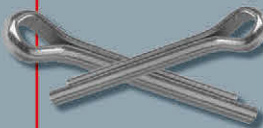

cotter pins

ASME B18.8.1	MS9245
MS24665	

the first choice in pins

FASTAR INC TEL (845) 369-7990

FAX (845) 369-7989 EMAIL fastar@optonline.net

2 Spook Rock Rd, #E-309, PO Box 929, Tallman, NY 10982-0929

www.fastar.com



Roman Basi

Roman Basi is the President of The Center for Financial, Legal & Tax Planning, Inc. Roman graduated from Milliken University obtaining a Bachelor's of Science Degree with a minor in Psychology. He earned an MBA from Southern Illinois University with an emphasis in Accounting and received his JD degree from Southern Illinois University. Roman is a licensed attorney in Illinois, Missouri and Florida and is in high demand for his expertise in financial, legal and tax matters. His areas of expertise include mergers and acquisitions, contracts, real estate law, tax and estate planning.

STOCK PURCHASE? ASSET PURCHASE? OR BOTH?

The structure of mergers or acquisitions are a major aspect of negotiation when buying or selling a business. In general there are two types of acquisition methods, a stock purchase or an asset purchase. However, in recent transactions we are seeing a hybrid type of transaction. This is one in which the Buyer makes an "election" to buy the Stock of the Company but have it treated as an Asset purchase for tax purposes. These "elections" are commonly found under IRS Section 338(h)(10), 338(g), and 336(e). While examining each type of election we will focus on some fundamental areas: (1) buyer; (2) seller; (3) target (a "target" is the company/business to be acquired); (4) qualifying offer (a "qualifying offer"; and (5) impact of election on purchase agreement of buyer and seller.

First, let's examine the structure and restrictions for buyers and sellers as part of a 338(h)(10) election. The 338(h)(10) is primarily concerned with the purchase of S-corporation stock. Unlike the 338(g) and 336(e) elections, the buyer in a 338(h)(10) can be a domestic or foreign corporation, but is limited to a single C or S-corporation. While the buyer can be domestic or foreign, the target corporation must be domestic. Additionally, the seller must be a U.S. corporation in the same group as the target, or an S-corporation stockholder. The qualifying transaction for such an election is a qualifying stock purchase. A qualified stock purchase requires that 80% of the stock be purchased in a 12 month period prior to the election. The 338(h)(10) election is proposed jointly by the buyer and seller. When the election is made, the transaction is technically a Stock Sale, but it is treated as an Asset Sale for Tax Purposes and depending on the dollar amounts allocated to the Assets, this can have a significant tax

impact to a Seller.

The next type of election is a 338(g), which differs from the 338(h)(10) in a number of aspects. One existing similarity is the buyer must be a single C or S-corporation. Unlike the 338(h)(10), the target can be either a domestic or foreign corporation. The seller in a 338(g) is almost unrestricted, as the seller is open to be one



or more corporate sellers, non-corporate sellers, or a domestic or foreign seller. Like the 338(h)(10) election, the 338(g) election requires a qualifying transaction wherein a qualified stock purchase of at least 80% must take place within a 12-month period. However, unlike the 338(h)(10), a 338(g) election is

chosen by the only by the buyer due in large part to the 338(g)'s double taxation. Due to the double taxation, both the buyer and seller should carefully consider clauses in the agreement that may allow or bar the 338(g) election, or more specifically the seller should require the buyer to increase purchase price to cover the taxation.

The final type of election is the 336(e), which shares some aspects of the 338(h)(10) and 338(g), but still has its own restrictions. A 336(e) election buyer can be one or more corporate, non-corporate, or even domestic and foreign buyers. Similar to the 338(h)(10) election, the target is limited to domestic C or S-corporations, and the seller is limited to domestic corporations as well. The qualifying transaction can happen through a qualifying stock disposition, however if it qualifies for a qualifying stock purchase, it will likely bar the 336(e) election. This type of election can also be chosen by the target and seller, but not the buyer.

The key to any of these types of elections is to understand what happens when a Buyer or Seller makes one and the tax implications it may have. 



BTM MANUFACTURING

15403 Andrews Rd Kansas City, MO 64147

TEL 1-800-369-2658

EMAIL sales@btm-mfg.com

WEB www.btm-mfg.com

BTM MANUFACTURING AWARDED ISO 9001:2015

ISSCO INC dba BTM Manufacturing is excited to announce ISO 9001:2015 certification. The new standard demands a high-degree of leadership commitment with greater emphasis on risk-based thinking and accountability throughout all organizational levels and processes. ISSCO INC dba BTM Manufacturing's quality management system is aligned and integrated throughout our business model with continued focus on customer satisfaction.

"I am thrilled to share the news that BTM Manufacturing is now ISO 9001:2015 certified. From early on, the management team at BTM knew that our success would be tied to becoming an ISO certified company, so we

intentionally set out to improve our quality management system. At BTM Manufacturing, our team is our greatest asset, so we will promote safety first, then quality, service and price as we continue to meet the expectations of our customers," says BTM Manufacturing President, Jake Davis.

ISO 9001 helps organizations demonstrate to customers that they can offer products and services of consistently good quality. It also acts as a tool to streamline their processes and make them more efficient at what they do.

BTM Manufacturing is committed to continual improvement and efficiencies

that will benefit our customers, and is proud to maintain compliance with ISO rigorous standards. 



BUSINESS FOCUS ARTICLE

BTM MANUFACTURING



U-BOLT | J-BOLT | EYE BOLT | ANCHOR BOLT | SPADE BOLT | STUDS | RODS | PER PRINT SPECIALS



Booth 3459

Domestic. Service. Quality.

Visit BTM Manufacturing in Booth 3459 at the Vegas IFE for a delicious cup of our specialty U-Bolt blend coffee!

INTERNATIONAL
FASTENER EXPO

www.btm-mfg.com

800-369-2658

sales@btm-mfg.com

DYNACAST INDUSTRIAL PRODUCTS

14045 Ballantyne Corporate Place, Suite 400, Charlotte, NC 28277

TEL 1-800-811-7841 FAX 704-927-2791 EMAIL sales@dynacast-ip.com WEB www.dynacast-ip.com



THE EVOLUTION OF DYNACAST INDUSTRIAL PRODUCTS - MORE THAN JUST DIE CAST FASTENERS

Dynacast Industrial Products offers the widest range of zinc fasteners in stock that include conduit nuts, pipe plugs, wing nuts, panel nuts, wood inserts, concrete anchors, cap nuts and more. Additionally, we offer custom zinc and aluminum die cast components, metal stampings, and precision rubber and elastomer products in a broad range of materials.

What began in 1936 in a small machine shop in rural New York has carved a path of innovation, acquisition, and growth across the decades. While rooted in North America as a division of Dynacast International, we utilize Dynacast's 23 global locations providing the lowest production cost while maintaining the highest quality and service standards. When customers demand high-volume precision parts with uniformity and design flexibility, our multi-slide technology cannot be matched. This process allows us to cast precise complex components and in some cases eliminate secondary operations.

OEM's turn to Dynacast Industrial Products for their critical, high-volume parts that are available in a wide variety of plating options and finishes. Our lines of conduit



nuts, pipe plugs and connectors are produced with the fastest production rates available, ensuring the lowest cost and parts that are die cast with clean, accurate threads and flash free.

Because of their inherent advantages, Dynacast Industrial Products is specified in hundreds of product categories including durable, lightweight, rustproof and corrosion resistant applications. For decorative purposes or where unusually corrosive conditions prevail, products can be plated in all commercial finishes. Our products are also excellent for outdoor use; they will not "freeze" on steel or aluminum fasteners.

If you have an idea for a new fastener or component, bring it to us.

Using our Value Analysis/Value Engineering (VA/VE) program we can determine if your current screw machine and cold form applications can be converted into die castings at a savings to you and your customers. If we determine that it's a candidate for die casting, we can use the knowledge and experience of our Dynacast Tooling Division to design and build a tool to produce the fastener to your exact specification. You will see significant cost savings without compromising integrity or performance. 



WING NUTS

Our wing nuts have the exclusive patented recessed wing for extra-firm grip and smooth washer-like bosses. The nuts can be used as cast or with nickel plating or other finishes for appearance or protection in the elements. The washer base wing nuts features washer diameters ranging from 1/2" to 7/8". We also offer a new line of stainless steel stamped wing nuts in both standard and high boss options.



PANEL NUTS

Dynacast's die casting technology work to the deliver an inexpensive alternative to screw machine or stamped panel nuts. Our patented single thread design is cast as an integral part of the process. The formed thread is strong, burr free and easy to start. We also offer tapped versions in a large assortment of thread sizes.



WOOD INSERTS & CONCRETE ANCHORS

The precision cast threaded inserts have sharp, staggered barbs for strong torque-out resistance. The high pull-out strength in both wood and plastic make these ideal for the furniture industry.

Our concrete anchors are durable and rust resistant, perfect for a variety of industries.



ELECTRICAL FITTINGS

Our line of conduit nuts provides reliable, durable performance with part to part consistency. Standard sizes range from 1/2" to 1 1/2" with a cast single thread design. New double bite design requires no orientation, ideal for automatic assembly. We also offer both straight and phillips pipe plugs in 1/2" and 3/4" sizes. All the items in our electrical line are UL approved.



CUSTOM COMPONENTS

At Dynacast we specialize in custom, non-standard fasteners and components. All our plants have state of the art engineering departments with the latest design software and years of experience. A design engineer will follow your project from early design meetings through sample approval. Our multi-slide tool allows us to hold tight tolerances on complex items. And in many cases we can modify an existing Dynacast owned tool to meet your re-quirements and keep cost to a minimum.



If it's an industry standard, chances are we've already made it. If not, we'll provide you with a quote to convert your next project to a precision die cast component. Contact us with your requirements and compare the cost savings!

ROTOR CLIP COMPANY INC.

187 Davidson Avenue, Somerset, NJ 08873

TEL 1-800-557-6867 FAX 732-469-7898 EMAIL RCBook@rotorclip.com WEB www.rotorclip.com



HOW TO CHOOSE A QUALITY SUPPLIER

by Anthony Brigandi



Today, it seems almost inevitable that with the expanding reaches of manufacturing specialization, your supply chain is sourcing and purchasing products from an extensive list of suppliers. In the hunt for speed to market and lowest costs, often times Purchasing Departments are stuck between a rock and a hard place in balancing the urgency needs of their company, the quality products their customers demand, with the ever-tighter budgets from which we are almost always constrained. The relaxing of purchasing constraints is often the easiest way to manage this balance, yet has opened up many OEMs to more risk than they are ready to admit.

With the largest multinational corporations reporting the management of upwards of 100,000 suppliers, and small to medium size businesses oftentimes in the 1000s, and with the recent international headlines warning about the billion-dollar losses from careless and fraudulent suppliers, by the likes of Takata Corporation and Kobe Steel, affecting household brand names like Toyota, Honda, and Hitachi, the manufacturing industry does not appear to be woken up to the risks of laissez-

faire supply chain management. It's about time that manufacturers take a proactive role in auditing and managing their suppliers, and only demanding the top quality for their end applications.

We will cover the state of the manufacturing industry and the risks associated with fraud and malfeasance, the existing solutions and their downsides, as well as offering a new framework in choosing a quality supplier you can trust, with a handy checklist you can print out or share with your team.

The High Cost of 'Little White Lies'

Over the last decade, we've become more accustomed to reading headlines on how suppliers are defrauding both OEMs and end-users with falsified safety documentation, sometimes with lethal and costly results. The most infamous of these cases was the widespread airbag recall from Takata, after which the faulty airbags that were supplied to a wide range of OEMs cost at least 8 lives. This recall was sparked after the identification of Takata falsifying safety documents regarding the reliability of its airbag inflators.

Enhance Your Packaging Department with 2018 Technology.

Bonotto packaging

Owner has over 45 years experience in packaging and counting.

- ✓ High Speed Counting Units
- ✓ Weigh Scales
- ✓ Vertical and Horizontal Bagging Machines
- ✓ Carton Forming and Closing
- ✓ Palletizing
- ✓ Material Handling and more...

**Ideal For
Distributors**



Quick Change Scale

Whether you package in boxes or bags, Bonotto Packaging can provide assorted Weigh / Count solutions for a wide variety of packaging needs.

We Can Think Big or Small...

Kit Systems



Bagging Systems



Contact Barbarotto Int'l Machinery.

Your Guide to Sensible Machinery Solutions.
**Barbarotto
Int'l Machinery**
Oceanside, New York



BarbarottoMachinery.com/New/Bonotto-Packaging

☎ 1-888-988-8703

Visit us at IFE 2018, Las Vegas Booth# 2808

Custom springs, stock springs American made since 1933!



Ajax Wire is a custom spring manufacturer par excellence. Your specific spring project is machined, formed and then delivered on time. Our inventory of stock springs and assortments in unique cases, provide profitable options, easy selection and makes dispensing efficient.

Ask for our Product Catalog which provides descriptions and size specifications.



www.ajaxwire.com

Toll Free: 855-966-AJAX (2529)

ajaxwire@aol.com



119 Bloomingdale Road, Hicksville, NY 11801

SPIROL INTERNATIONAL CORP.

30 Rock Avenue, Danielson, CT 06239

TEL 1-860-774-8571 FAX 1-860-774-2048 EMAIL info@spirol.com WEB www.spirol.com

SPIROL®

HOW DEFLECTION RANGE AFFECTS THE PERFORMANCE OF DISC SPRINGS by John Leckfor, Applications Engineer

Disc Springs are conically shaped washers designed to provide predictable and repeatable performance. They may be used to either apply a static load, where the load is nearly constant, or in dynamic situations, where the Disc Spring is experiencing repeated loading and unloading. It is critical to understand how load characteristics affect performance to properly design a system that uses Disc Springs.

Springs are unlike other assembly components; they are designed to deflect and store mechanical energy. The deflection of a Disc Spring is predictable, making it possible to estimate the life cycle of a Disc Spring in an assembly. Optimal Disc Spring performance is achieved when working deflection is kept between 15% and 75% of full deflection. It is in this range that measured results most accurately match the theoretical characteristics of Disc Springs (Figure 1).

The measured characteristic curve in the lower range (less than 15% of full deflection) departs from the theoretical curve due to residual stress. In the midrange of the curve, corresponding to the normal working range of the Disc Spring, the measured and theoretical characteristics are very similar. As deflection increases beyond 75% of full deflection, the force moment arm is reduced and deviation from theoretical characteristics rapidly increases. It is for this reason predictability of force/deflection is restricted to the normal operating range of the Disc Spring.

Disc Life

Static Load

Static loading is defined as carrying a constant load or a load that changes at relatively long time intervals - not exceeding 10,000 cycles for the life of the design. In static applications, the highest calculated stress at mid-span of

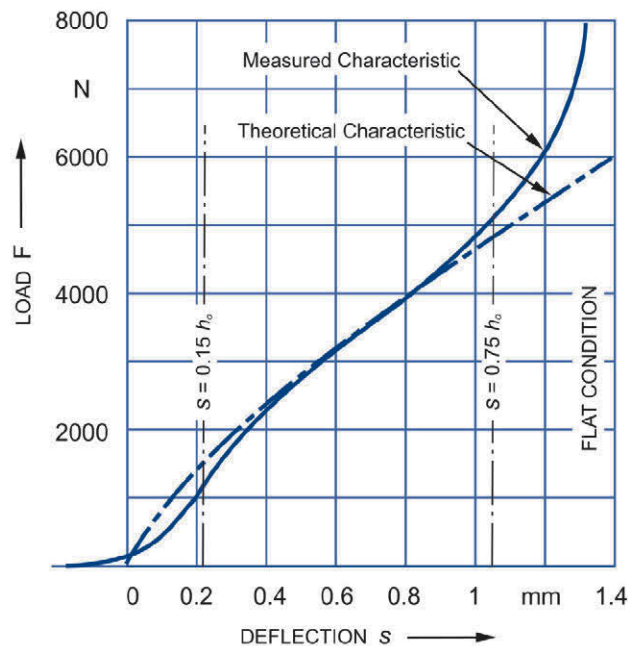

FIGURE 1 - N 16983, GROUP 2, SERIES B 50 X 25.4 X 2 (FORMERLY DIN 2093)

the top surface of the Disc Spring is critical. (Shown as Point O in Figure 2.) At this point, the highest calculated stress should not exceed the approximate tensile strength of the material (1400-1600 N/mm²) when the Disc Spring is in the flat position. Standard Disc Springs may be used in static loading without performing theoretical calculation if deflection is kept to less than 75% total.

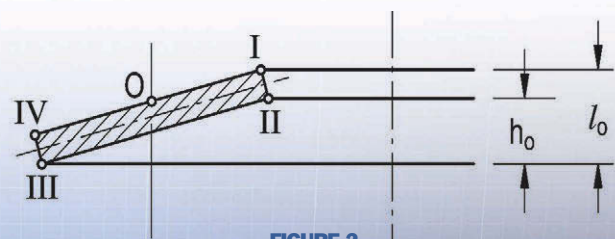

FIGURE 2

SPIROL®

Innovative fastening solutions. Lower assembly costs.



Coiled Pins



Solid Pins



Slotted Pins



Threaded
Inserts



Compression
Limiters



Spacers



Ground Hollow
Dowels



Alignment Dowels
& Bushings



Precision
Metal Shims



Thrust
Washers



Disc
Springs

- **30,000+ Standard Items**

- **MS/NASM & NAS Certified Parts** • **RoHS and DFARS Compliant**
- **Available to Ship from Stock** • **No Tooling Charges**



Visit us at Booth 3351
International Fastener Expo

World's Largest Fastener Show
Oct 30 - Nov 1, 2018
Las Vegas, NV

SPIROL.com P 800.321.4679 F 860.774.0487

Providing manufacturing and application engineering expertise since 1948.

IATF 16949

NORTH AMERICA



SOUTH AMERICA



EUROPE



ASIAPACIFIC



FAR SRL

Via Giovanni XXIII, 2 - Fraz. Quarto Inferiore, 40057 Granarolo Emilia - Bologna - ITALIA

TEL +39 051 6009591

FAX +39 051 768284

EMAIL export@far.bo.it

WEB www.far.bo.it

OVER 60 YEARS OF ITALIAN EXPERIENCE IN THE FASTENING WORLD

Founded in 1957, FAR s.r.l. is a family-owned business and is a leading company in Italy and in Europe in the production and distribution of high-technology articles for fastening.

Highly specialized employees supported by 2 automatic warehouse systems and semi-robotised packaging units in a 14.000 sqm-plant - based in Bologna - ship daily towards more than 70 countries in the world a great varieties of 1.blind rivets, 2.blind rivet nuts, 3.tools and semi-automated solutions.

A short overview of the product range strictly 100% manufactured in Italy:

▣ **Blind Rivets:** thanks to a very wide and diversified experience, FAR produces more than 600 standard articles and a wide selection of structural and high-performance blind rivets complete the range. Structural blind rivets are designed for applications requiring a vibration resistant solution and great clamping power, allowing fast and easy installation. Structural blind rivets from FAR are first-class fasteners and are greatly employed in industrial equipment, automotive and commercial vehicles especially where absolutely safe and secure connections are essential.

▣ **Blind Rivet Nuts:** the offer of a standard stock range consists in a wide variety of more than 200 blind rivet nuts supplied with knurled bodies, to provide better grip and higher resistance in metric threads sizes from M3 to M12

▣ **Tools and Semi-Automated Solutions:** available in over 30 models the whole range includes manual, power, industrial tools and automation systems designed to perform at the most efficient level with maximum power by increasing speed, quality and consistency in the assembly process.

More details about FAR complete range of products

are available at the released website www.far.bo.it containing explanatory videos on the most frequent routine maintenance works, diverse technical data sheets and a wide series of applications of FAR designed technologies to several industries. FAR web site is a unique technical encyclopedia of the fastening know-how and mirrors the attitude of FAR founder: willingness to share the acquired know-how to support users in their daily works.

Website technical support combined with practical training at "FAR Training Centre" in Bologna plant represents the heart of the Company, a meeting point which enable FAR tool users to focus on quality assistance service. Each

training is designed to users specific needs and applications and assures a constant updating on FAR technologies and innovations. Video technical assistance on demand for fast problem solving is also an option for FAR customers.

A further fundamental pillar for the worldwide distribution of FAR products are a continuous improvement of the organization and production processes to provide quick goods delivery. In fact, FAR offers thousands products available from the extended warehouse at short notice granting smooth, fast and reliable deliveries.

FAR technologies have been distributed in the US for more than 20 years and are already very well known by the insiders of the fastening technology as a quality product, long lasting and with a very highly competitive price. In the US, FAR entrusts its distribution to a strong net of authorised dealers with a solid experience and excellent image in this sector, ready to quickly react to customers' needs thanks to their extensive FAR tools inventory. To their support, FAR tool repairs centre can act, if needed supporting FAR technology & assure a prompt service to customers all over North America. 



FAR
BOLOGNA
ITALY
60th
SINCE
1957

Manufacturer of
BLIND RIVETS
RIVET NUTS and
RIVETING TOOLS



MADE IN ITALY



FAR S.r.l. Via Giovanni XXIII, 2 - Fraz. Quarto Inferiore
40057 Granarolo Emilia - Bologna - Italy
Ph: +39 - 051 6009511 Ph: +39 - 051 6009591
Fax: +39 - 051 767443 Fax: +39 - 051 768284
e-mail: commerciale@far.bo.it e-mail: export@far.bo.it
> web: www.far.bo.it

★ **AUTHORIZED DEALERS**

BAY FASTENING SYSTEMS
30 Banfi Plaza , N.- Farmingdale, NY 11735
Toll free U.S.A.: 1-800-718-8818
E-mail: info@baysupply.com
<http://www.baysupply.com>

HANSON RIVET & SUPPLY CO. INC.
13241 Weidner Street – Pacoima – CA - 91331
Tel.: 818-485-0500
Toll free U.S.A.: (800) 777-4838
Fax: 818-485-0540
E-mail: mail@hansonrivet.com
<http://www.hansonrivet.com>

ACE RIVET & FASTENER INC.
34 Strathearn Avenue
Brampton – Ontario - L6T 4L8
Toll Free #: 1(800) 366-0489
Local Phone: (905) 792-2255
Fax: (905) 792-1529
E-mail: sales@acerivet.com
<http://www.acerivet.com>

ARKANSAS BOLT CO. -
2701 West Roosevelt Road
Little Rock, AR72204
Tel. 001/5013750244
Fax: 001/5013756028
E-mail: mail@arkansasbolt.com
<http://www.arkansasbolt.com>

★ **TRAINING CENTRE**

AERO TOOL SERVICES
120 East Felix Street, Suite 303, Fort Worth, TX 76115
Tel. 817-556-1815
E-mail: techservices@aerotoolservices.com
<http://www.aerotoolservices.com>





DUNKLEY INTERNATIONAL, INC.

The new **Mach-10** has been improved with:

- Updated components
- Lighting system
- Camera lensing
- Updated design

Specifications:

- Mixed, damaged, or out of tolerance parts are rejected automatically, without human intervention
- Inspection rates up to 10,000 parts/min. (based on components & inspection parameters)
- Easy setup
- Inspection parameters are saved and stored in the machine's computer for recall and setup
- Inspection data can be archived on the machine or sent to a central server for process and quality control analysis



Now **ISO 9001-2015** certified!

This allows us to mitigate risk, enhance customer service, increase product reliability, while still being price competitive!

New **Mach-10**, the Multi Part Flexible Vision Inspection System



High Speed Inspection for Various Calibers of Ammunition, Fasteners, Threaded Parts, Washers, Rivets, Nails, etc.

1910 Lake St.
Kalamazoo, MI 49001
(269) 343-5583

www.DunkleyInternational.com



distributornews

to perform spot welding or other secondary operations, saving time and money during production.

This family of inserts includes half-hex shank low-profile head, rib-wall minimized-profile head, rib-wall low-profile head, thin-wall low-profile head, and swaging low-profile head versions.

A variety of available thread sizes range from #6-32 to 1/2"-13 and M4 to M12, depending on insert type. Custom inserts also can be engineered to satisfy specific application performance requirements

Detailed specifications, fastener drawings and 3D models, and performance data (ATLAS Catalog) for these RoHS-compliant inserts can be viewed and downloaded for free at www.pemnet.com.

Founded in 1942, PennEngineering (Danboro, PA, USA) is a global leader in the fastening industry with technical and manufacturing facilities in North America, Europe, and Asia supported by a global engineering-focused sales force and a worldwide network of authorized distributors.

For more information, contact Michael J. Rossi, PennEngineering at 5190 Old Easton Road, Danboro, PA 18916-1000 USA. Telephone: +1-215-766-8853, email: info@pemnet.com or visit them online at www.pemnet.com.

distributornews

ATLAS® SpinTite® blind threaded inserts from **PennEngineering®** provide strong, permanent, and reusable threads in thin sheet materials where only one side is accessible for hardware installation. Installation is performed from the accessible "front" side using spin-spin tooling technology. The inserts then become permanently mounted on the "back" side to accept a mating screw for final component attachment. The "blind" installation capability especially suits applications such as tubing, extrusions, and others where access to the back side is either limited or nonexistent.

These steel, aluminum, brass, or stainless steel inserts ideally



replace tapped holes, weld nuts, rivets, self-drilling or tapping screws, and through-bolted applications necessitating loose hardware. They support close-to-edge applications and can be installed at any stage during the production process (even

after assemblies have been painted). In service, the inserts exhibit high thread strength and high torque-out resistance.

ATLAS SpinTite inserts have been designed for use with panels or sheets of any hardness or material (including metal, plastics, and fiberglass) and as thin as .020" / 0.51mm. They additionally can assemble multiple dissimilar materials during installation, eliminating any need

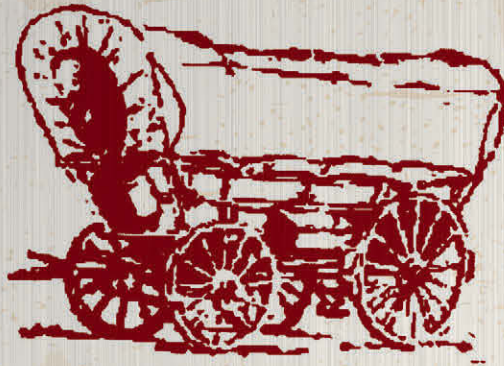

BIG RED FASTENERS

OKLAHOMA'S LARGEST B7 STUD MANUFACTURER & DISTRIBUTOR

TURNAROUNDS | MAINTENANCE | NEED IT QUICK | SAME DAY SERVICE

**ASTM A193 B7
ASTM A193 B7M**

BOLTS
CAP SCREWS
MACHINE SCREWS
LAMALLOY PRODUCTS
LOCKNUTS
SOCKET PRODUCTS
NUTS
CONSTRUCTION
WASHERS
METRIC

**ASTM A193 B16
ASTM A320 L7**

WOOD SCREWS
DECKING SCREWS
TAPPING SCREWS
SELF-DRILLING SCREWS
BRASS
STAINLESS
WIRE ROPE & CHAIN
STUDS
ANCHOR PRODUCTS
PINS

**ASTM A320 B8
ASTM A320 B8M**

THREADED PRODUCTS
BENT & FORMED BOLTS
RIVETS
THREAD CUTTING SCREWS
THREAD ROLLING SCREWS
CHANNEL STRUT
MISCELLANEOUS
STEEL TANK INDUSTRY
PRODUCTS

NOW STOCKING XYLAN BLUE STUDS* AND CAD PLATED STUDS*

***COMMODITY OD SIZES 1/2" - 1 1/4"**

CHECK AVAILABILITY

489 North Poplar, Broken Arrow, OK 74012
918-251-7291 | Fax: 918-251-7311 | Toll Free 1-866-621-6565

www.bigredfasteners.com

BRICO INDUSTRIES INC.

777 N Larch, Elmhurst, IL 60126

TOLL-FREE 1-800-32-BRICO

TEL 630-833-0700

EMAIL brico@bricoind.com

WEB www.bricoind.com



BRICO – BRIGHT NAME IN MIDWEST MANUFACTURING



Quality Fasteners Made In The USA

Brico specializes in manufacturing fasteners in aluminum, brass, stainless steel, as well as steel in #4 to 1/2 diameters up to 4" in length. They manufacture a wide variety of screws such as Thread Cutting, Multi Blow, Self-Drilling points, Thread Forming, Tri-roundular, Thread Forms for Plastic, and Sheet Metal in virtually all drive styles including 6-lobe, Phil Square, Square, Combinations, Tamper Proofs, Hex, Hex washer and external 12-point drives.

ISO 9000

Long before the ISO 9000 standard was established in 1987, Brico Industries was using the philosophy as its guiding principle. Brico implemented their Quality Assurance and Traceability Procedure in the early 70's.

When the ISO standard was established, they became certified. Even then, they were ahead of the curve. They have been striving for continuous improvement since the outset.

Midwest Work Ethic

People that join Brico Industries find a home there. They currently have over 25 employees that have been there for at least 19 years, some much longer. They

are treated well and they learn the business; they work hard and they stay there. Brico's people are one of their greatest assets.



Modest Beginning

It's interesting how things work. Back in November 1, 1970 in Rosemont, IL, they probably didn't envision all that has come to pass. When they started, they were a two-man distributor in a 3,500 sq. foot warehouse. This was the start of "The Bright Name in Fasteners." It is amazing to see what they have accomplished.



distributornews

The Gilchrist Foundation has awarded five scholarships from the 2018 applicants.

Congratulations to the recipients. We wish them well and are pleased to assist them with their education. They are as follows and their sponsoring companies;

Martha Crow

Wurth Revcar, Frederick, MD

Madeline Bartush

XL Screw Corp., Lincolnshire, IL

Michael Byrne

Wurth Adams, McAllen, TX

Rachael Edge

Ameribolt, Inc, Sylacauga, AL

The final award will be given to an applicant from the Mid-West Fastener Association when they meet in November.

Robbie and Gina Gilchrist established the Gilchrist Foundation Fastener Scholarship in 2000. Their goal was to return something to an industry that was very good and supportive to them. The Gilchrist Foundation invites any person wanting to further their education to apply for the scholarships. Applicants can be full time or part time students working in the industry or children of working fastener people. The Foundation has awarded 63 scholarships since its beginning!

For additional information visit the foundation website at www.gilchristfoundation.com.

Thread Repair Kits



Installation Kit:
Solid wall inserts for metal



Installation Kit:
Coil inserts for metal



Assortment Kit:
Solid wall inserts for metal



Installation Kit:
Knife Thread inserts for wood



Assortment Kit:
Knife Thread inserts for wood



Assortment Kit:
Hex Drive inserts for wood

EZ LOK

Threaded Inserts for Metal, Plastic & Wood



(800) 234-5613 • www.ezlok.com

MW INDUSTRIES, INC

2400 Farrell Rd, Houston, TX 77073

TEL 1-800-875-3510 EMAIL sales@mwindustries.com WEB www.mwindustries.com



CUSTOMER-CENTRIC: AT OUR CORE

For more than 43 years, we have been putting the needs and requirements of our customers first – ahead of everything else. This is the reason for our rock-solid position in the industry and the reason why we continue to expand our operations and purchase new equipment. Being in the trenches and fully knowing our business allows us to meet our customers exactly where they are. Providing our customers with quality, high-performance washers, stampings and specialty fasteners, helps ensure the performance of our customer's end product therefore extending our impact to our customer's customers. This gives our customers' peace of mind. They trust us because they know that we know they are why we exist. Another principle focus of our customer-centeredness is our attitude towards doing what we commit to and keeping our promises. We deliver consistently great experiences, doing what is right for the customer, even when an issue or hiccup arises.

In staying true to our overarching principle of exceeding our customer's needs, we've added the following new machines:

- ▣ **Hurco VMX 42i Mill with a 4th Axis**, which delivers improved machine time and quality.
- ▣ **Hurco TM 10i Lathe with Bar Feeder**, which accelerates the speed of production.
- ▣ **ACER AGS 1640 Surface Grinder**, which provides more precise tooling with exceptional quality; a good start makes for a great finish!

**Stop by and visit us at the 2018 Las Vegas
– International Fastener Expo - Oct 30 - Nov 1.
Booth # 3056**



HURCO VMX 42i MILL WITH A 4TH AXIS



HURCO TM 10i LATHE WITH BAR FEEDER



ACER AGS 1640 SURFACE GRINDER

WASHERS



METAL STAMPINGS

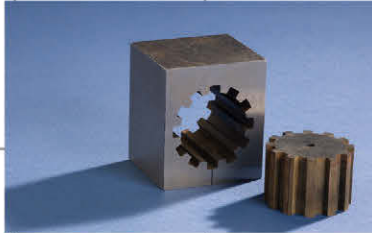

SPECIALTY FASTENERS



The MW Advantage

- Celebrating 40+ years
- Rush orders
- On-time delivery
- ISO 9001:2008 Certified
- Request quotes online
- One of a kind & large quantities
- 1 ton to 500 ton capacity



2400 Farrell Rd. • Houston, Texas 77073

Tel 281-233-0448 • Fax 281-233-0449

Toll Free 800-875-3510

sales@mwindustries.com

www.mwindustries.com



PACIFIC-WEST FASTENER ASSOCIATION

3020 Old Ranch Parkway #300, Seal Beach CA 90740

TEL 562-799-5509 FAX 562-684-0695 EMAIL info@pac-west.org WEB www.pac-west.org

KEVIN CHAVIS RE-ELECTED PAC-WEST PRESIDENT

by Vickie Lester

Kevin Chavis of Star Stainless Screw (Commerce, California) was elected to serve a fourth term as president of the Pacific-West Fastener Association at a recent meeting of the Pac-West Board of Directors.

Ron Stanley of Empire Bolt & Screw (Spokane, Washington) was re-elected as the association's vice president, and Gigi Linsalata of Copper State Bolt & Nut (Phoenix, Arizona) is the new secretary/treasurer. Rick Peterson of All-West Components & Fasteners (Seattle, Washington) stays on the Board as immediate past president.

David Palmquist of N-D Industries (Santa Fe Springs California) and Ed Smith of Wurth Timberline (Commerce City, Colorado) were elected by the Pac-West membership to serve three-year terms on the Board of Directors.

Other members of the Pac-West Board are Trevor Borland of Pacific Bolt Manufacturing (Langley, British Columbia), Joshua Hutton of American Bolt & Screw (Fontana, California), Steve Kendall of Portland Screw (Portland, Oregon), Beth Van Zandt of Desert Distribution (Santa Clarita, California), Doug Weiland of Stelfast (Milpitas, California), and Scott Webb of Bisco Industries (San Diego, California)

At the association's recent fall conference, tribute was paid to retiring Board members Corey Bell of THB Inc. (Salt Lake City, Utah) and Chris McCaffrey of R&D Fasteners (Rancho Cucamonga, California).

Pac-West's 2018 fall conference took place August 9-11 at the Grouse Mountain Lodge in Whitefish, Montana. The conference featured the perfect mix of stimulating educational programs and fun events.

Education offerings at the Pac-West 2018 fall conference included:

- Useful business contract tips and an explanation of antitrust activities from legal counsel Mark Alcorn
- "How to Attract, Develop and Retain Young Workers for Jobs They Don't Consider Sexy," by Eric Chester
- "Cybersecurity Made Easy," by Jeff White and Will Snyder of WTC IT Services
- Daniel Riggs' (Wurth Industry North America) insightful presentation on "Trump's Tariffs"
- A conversation with former Montana Governor Marc Racicot
- Interactive forum discussions on a wide range of fastener industry and business topics

Conference social events included golf at the White Fish Golf Club, a spouse/guest lunch on Whitefish Lake, and a contest for the best western wear followed by an evening of boot scootin' line dancing.

Pac-West's next conference will be a joint meeting with the Mid-West Fastener Association and the National Fastener Distributors Association, March 13-16 at the Omni Hotel in San Diego, California.

Also on the schedule for 2019 is the Pac-West Fall Conference, October 24-26 at the Doubletree by Hilton Sonoma Wine Country, in Rohnert Park, California.

For more information about Pac-West and its activities contact Vickie Lester, CAE, executive director, Pacific-West Fastener Association, 3020 Old Ranch Parkway #300, Seal Beach CA 90740, 562-799-5509, fax 562-684-0695, e-mail vl Lester@pac-west.org, www.pac-west.org. 

Your reliable option for FORMED SPRING STEEL FASTENERS



Supplying Distributors Nationwide Since 1989



U-CLIPS



U-NUTS



J-NUTS



SPECIALS

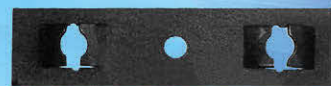

TWIN NUTS



FLAT NUTS

- DIRECT COMPETITOR MATCHES
- DISCONTINUED ITEMS!
- FACTORY DIRECT PRICES
- MANY IN-STOCK ITEMS
- SHORT LEAD TIMES
- ON TIME OR B4 DELIVERY

e-quality-fast →[®] brand

Your *e*-conomical Source
for *qual*-ity Fasteners
and *fast* → Delivery

405 Production Drive • South Elgin, Illinois 60177

Toll Free: 888-NUTS-R-US (888-688-7787)

Fax: 847-695-6336

On Line: www.e-quality-fast.com

E-mail: sales@e-quality-fast.com

OSSCO BOLT & SCREW CO.

1351 Elmwood Ave.
Cranston, RI 02910
FAX (401) 461-6970
Email: sales@osscobolt.com

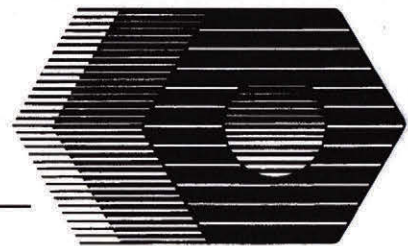

Just Arrived!
Special: Left Hand
Finish & Jam Nuts



* \$25.00 minimum order

- Castellated Nuts
- Slotted Nuts
- Hi-Nuts
- Square Nuts
- Left Hand Nuts
- Left Hand Jam Nuts
- Gr. C. Prevailing Torque
- Flange Nuts
- Slip-on Locknuts

- Centerlock Nuts
- Nylon Insert Lock Nuts
- Thin Nylon Insert Lock Nuts
- K-Loc
- Wing Nuts (Forged)
- Acorn Nuts
- 2H Nuts
- Machine Nuts

- Finished Nuts
- Gr. 8 Nuts
- Tee Nuts
- Galvanized Nuts
- DIN 934-Finished Nuts
- DIN 985-Nylon Stop Nuts
- DIN 980-Prevailing Torque
- Acme Nuts

- Coupling Nuts
- Cotter Pins
- Gr. 8 Lock Washers
- Gr. 8 Flat Washers
- Fender Washers
- Toggle Wings
- Toggle Bolts
- Plastic Anchors



Call 1-800-FOR-A-NUT
1-800-367-2688

INXSQL/INTEGRATED INVENTORY SOLUTIONS



1117 S. Cass Lake Road, Waterford, MI 48328

TEL 1-877-4-INXSQL / 1-877-446-9775 FAX 248-681-6677 EMAIL sales@inxsql.com WEB www.inxsql.com

BUILT FOR SUCCESS

Fastener Supply Company of Charlotte, North Carolina has served the needs of OEM's in the Southeast for almost 60 years. They focus on providing highly specialized products and services with a keen eye towards quality, reliability and support throughout the entire process.

As Fastener Supply continued to grow, they realized that replacing their existing accounting software with a more complete distribution ERP system was critical to their future success and growth. Selecting a company that could provide highly functional software, a vision and who would become an active partner with them was critical.

After an exhaustive search that looked at all aspects of their business including their current needs and projected future requirements, Fastener Supply chose INxSQL Software of Waterford, Michigan.

Tony Nelson, Purchasing Manager at Fastener Supply and an active member of the selection team outlined several areas of critical interest. They needed a cohesive system to better manage their five autonomous branches. They needed better control of their inventory. They also needed to automate many processes that were formerly manual. And, they needed to accomplish this without impacting their high level of customer service.

Nelson points to tools like INxSQL Contact Management which has given them access to critical data in real time. With INxMOTION, they look forward to

extending the reach beyond the walls of the company and into the field and customer sites using existing mobile devices.

Inventory control is a problem for every distributor. Organizing the warehouse, analyzing usage and making sure that the proper mix of product at each location, at the right time, is vital to a successful company like Fastener Supply. Keeping track of this expansive inventory is also time consuming. Nelson said that in their recent physical inventory, with INxSQL in place, they were able to reduce the time 30-50% while increasing accuracy.

Reducing costs, simplifying processes, and building the customer relationship were a few of Fastener Supply's goals. Nelson says that they look forward to continuing to expand their use of INxSQL. In the short-term, Fastener Supply has their sights set on expanded Quality Control, automated VMI, Graphical Dashboards and a fully integrated website to enhance their customers experience.

Meeting and exceeding customer's expectations these days requires business partners who work with you, not at you. Donnie Shrum, President of Fastener Supply had this to say, "Our management team was unanimous in saying that INxSQL is the best platform they've used". He also said that while functionality was important, the relationship and the attention paid to Fastener Supply by the entire INxSQL team has proven to be the most important part of the equation.

Keith Jones, Vice President of Sales for INxSQL said "working with a company like Fastener Supply is a pleasure. They identify the issues to be tackled and begin looking at the capabilities of the software and their existing processes to find the best way to resolve them. There are no sacred cows, everything is on the table when it comes to streamlining processes to better serve the company and their customers." 



TOP 5 REASONS why your INVENTORY Management Software STINKS!

- 1) *The support is subpar - it's hard to get a call back*
- 2) *The software doesn't fit your business - because the software company knows nothing about your industry*
- 3) *It's too expensive to maintain - the support costs are high and the upgrades are expensive*
- 4) *It's hard to use - too many steps in simple processes*
- 5) *Someone purchased your software provider - ongoing support & development of the software is in question*

If you're ready to upgrade from "stink" to "awesome" contact us.

INxSQL.com



877-446-9775



Mundelein, IL 60060
Ph: 847.566.9091
Fax: 847.566.8381
www.washerwerks.com
sales@washerwerks.com



All American Washer Werks is a stocking manufacturer of washers. We cater to both high & low volume requirements.



- Quality Producers of Washers and Stampings
- Many Sizes Available 8" OD to .500 Thick
- ISO 9001-2008
- Most Metallic & Non-Metallic Materials
- Stocking Manufacturer
- Fast Quotations & Quick Delivery

SS Fasteners

Mehta Trading Intl.

**The Complete
Stainless Steel
Fastener Source for
*MILL Shipments***



**Mehta
Trading
International**

For Competitive quotes, call us at
972-642-1012
Fax RFQ at 972-642-1244
email: corp@MehtaTI.com
www.MehtaTI.com

**Where Pursuit of Progress
is Endless**

distributornews

Minneapolis, Kansas, based manufacturer and master distributor, **G.L. Huyett**, announces its acquisition of Phoenix, Arizona, based AZ Lifting Hardware (AZLH), a privately held lifting hardware distributor.

G.L. Huyett's CEO, Tim O'Keeffe, explained, "This acquisition complements G.L. Huyett's strategy to grow our business exponentially through the addition of products and services that add value to our customers. We now have a warehouse located in the Southwest, allowing us to reduce freight costs to the West Coast for G.L. Huyett products, as well as plans to dispatch lifting hardware to our Tennessee Warehouse to reduce freight costs for customers on the East Coast."

Since 2006, AZLH has distributed a diverse range of lifting, rigging, and suspension hardware for shipping, construction, and architectural industries across North America. "I started this business with a mission to offer high quality hardware at fair pricing, 'Global Sourcing with Domestic Standards.' It has been a great run, and this is a perfect fit. I am excited that G.L. Huyett will extend and leverage what we have built over the past decade," expressed Chuck Smith, AZLH President and Founder.

AZLH's primary product lines of eye bolts, turnbuckles, and shackles, along with chain and rope fittings, are immediately available online at www.huyett.com.

Smith reflected, "While I am sentimental in retiring, I know that G.L. Huyett is the best partner for my employees, customers, and suppliers. I have been impressed with how fair and forthright they have been in executing the transaction." O'Keeffe revealed, "This is our fourth acquisition in three years. In each case, I can still count on the seller as a friend and trusted colleague, and I know that will be true with a great entrepreneur like Chuck Smith." O'Keeffe noted further, "We are still in the market to acquire businesses of other retiring or interested entrepreneurs and hope to continue to add products and locations so we can provide greater value to our distributor customer base."

For more information contact G.L. Huyett by Tel: 785-392-3017, Fax: 785-392-2845, Email: sales@huyett.com or visit them online at www.huyett.com.

Fit

Developed specifically for
distribution businesses

Ease

At the leading edge of
technology for ease of use

Growth

Uniquely positioned to drive
growth and profitability



Technology Fit For Distribution Businesses

Epicor® Prophet 21® business software is built for the everyday business processes of fastener distributors—including order entry, eCommerce, vendor-managed inventory, lot tracking, tagging, and landed costs. Epicor software is designed so your distribution business can scale, adapt, and grow without costly system modifications—in the cloud or on premise.

Epicor makes it easy for distributors to stay current on technology fit for your industry, and empowers you to drive digital transformation and growth.

-  [epicor.com/fasteners](https://www.epicor.com/fasteners)
-  distributionexperts@epicor.com
-  1.800.776.7438

Visit Epicor at the
International
Fastener Expo and
at STAFDA

EPICOR®

MID-WEST FASTENER ASSOCIATION

PO Box 5, Lake Zurich, IL 60047

TOLL-FREE 1-800-753-8338 TEL 847-438-8338 EMAIL mwfa@ameritech.com WEB www.mwfa.net

MWFA FASTENER SHOW DELIVERS

by Nancy Rich

On June 4th, the MWFA hosted their 37th Annual Fastener Show. The location of this show offers exhibitors and attendees the opportunity to meet in the heart of the fastener industry. Exhibitors from across the country and Taiwan were on hand to feature products and services. With there being a great fastener concentration in the Chicago area, companies were able to send several attendees without incurring travel expenses.

Prior to the show, a very informative panel discussion was held. The panel consisting of Tabitha Herbst of Central Wire, George Hunt of Brighton Best, Charlie Kerr of Kerr Lakeside and Paul Cincinello of Worldwide Logistics drew a large audience interested in the future of the fastener market with proposed tariffs as well as other inflationary issues. Read more about this discussion, in this newsletter, in the Panel Discussion article provide by John Wolz of GlobalFastenerNews.com. The best way to be informed of what is going on in the industry is to talk to those keeping a close watch on the pulse of the industry so the audience was very fortunate to learn from our panelists.

Following the show the MWFA and sponsors hosted the popular Fastener Bash, as named by the MWFA. Harris Kal, formerly of Happy Days, entertained the crowd while they enjoyed cocktails and dinner. We sure saw the industry let loose playing games, building towers, and creating a fun show for the observers. The fastener industry family especially enjoyed playing Family Feud!!

At the Fastener Bash, Wayne Wishnew took a minute to thank Bob Baer of Abbott Interfast for his leadership as MWFA President the last two years. Bob continued to lead the association to new successes while working with a strong Board to continue the association's strong role in our industry.

The MWFA is a non-profit association working hard to serve its members and the fastener industry. This show is one of the great opportunities the MWFA offers and in return gives back to the industry through education and scholarships. The MWFA sends out a huge thank you to those who supported this event and appreciate the benefits and great networking of associations.

We Appreciate Our Sponsors

Gold Sponsor

- ▣ Kanebridge Corp.

Bronze Sponsors

- ▣ BTM Manufacturing
- ▣ Distribution One
- ▣ Eurolink FSS, LLC
- ▣ Metric & Multistandard Components
- ▣ National Fastener Distributors Association
- ▣ Superior Washer
- ▣ XL Screw Corp.

MWFA Welcomes New Members

All America Threaded Products, Inc. - Denver, CO

Alper Services LLC - Chicago, IL

Components Company Inc. = Brookfield, WI

Fascomp Electronic Hardware - Orlando, FL

Fastener Superstore - Downers Grove, IL

Jackson Manufacturing, Inc. - Maquoketa, IA

Viking Products, Inc. - Grand Rapids, MI

2018 MWFA Calendar

November 8 Scholarship/Elections Dinner Meeting
Belvedere Banquets, Elk Grove, IL

December 13 Holiday Party

Medinah Banquets, Addison, IL 

MID-WEST FASTENER ASSOCIATION TABLE TOP SHOW ELK GROVE VILLAGE, IL - JUNE 4, 2018



Did You Know...?

Global Sourcing
Direct Import/Customs Clearance
Large Global Supply Base



Screw Machine Products



CNC-High Precision

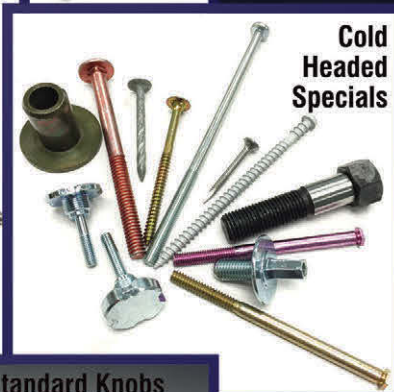

Cold Headed Specials



Custom & Standard Knobs

Design - Prototype - Production - VMI
Supply Chain Management
Lower Costs, Higher Efficiencies

AIC
 SINCE 1948

QUALITY & INTEGRITY

ABBOTT-INTERFAST ISO 9001

190 Abbott Drive Wheeling Illinois 60090
 Toll Free 888.490.9424 Website: www.aicfast.com

distributornews

MW Industries, a leading provider of highly engineered springs, specialty fasteners, machined parts, and precision components, announces the acquisition of Ameriflex, Inc., a leading manufacturer of precision formed metal bellows and bellows assemblies used in applications supporting the semiconductor, microelectronics, and aerospace industries.

Located in Corona, CA, Ameriflex was founded in 1981. Ameriflex produces bellows, flexible metal hoses, and metal flanges used in the vacuum electronics industry. The company's highly engineered products are chosen because of their exceptional performance in meeting the tight tolerances and exacting specifications demanded in vacuum applications. The company also produces custom assemblies, combining bellows and flanges together in value-added assemblies.

MW Industries, Inc., headquartered in Rosemont, IL, has been a leading provider of highly engineered springs, specialty fasteners, machined parts and precision components for more than 50 years. The company excels at rapid prototyping and design of hard-to-make products made from specialty materials. MW Industries serves more than 23,000 customers in over 35 countries with 45,000+ products

For more information contact MW Industries online at www.mw-ind.com.

INTERNATIONAL FASTENER EXPO
 International Fastener Expo
 October 31 - November 1, 2018
 Las Vegas
 Visit us at Booth 2723

THE SENSE OF SAFETY

POLEPROSTUDIO™

ELECTRIC TERMINAL WASHERS



TOOTH LOCK WASHERS



CONICAL CONTACT WASHERS



FLAT AND CONICAL WASHERS FOR SEMS



RAILWAY SPRING WASHERS



FLAT RIBBED WASHERS



ECCENTRIC WASHERS



CONICAL SPERRKANT WASHERS



WE LOVE SAFETY.

Over 70 years of safety and railway spring washers, according to International standards or custom drawings, backed by a Quality System certified to IATF 16949.

We are experts in the manufacture of SEMS washers for the automotive industry as well as spring washers for railway tracks. **Our quality products are for**

applications where safety really matters. Our production is 100% in house, this control allows quality washers for high performance and long service life.



Production plant: GROWERMETAL S.R.L. - VIA NAZIONALE 3 - 23885 CALCO (ITALY)
 Phone: +39 (039) 953-5300 Fax: +39 (039) 953-5400 E-mail: info@growermetal.it

US office: G&G SAFETY FASTENERS LLC, 1201 MT. KEMBLE AVENUE, MORRISTOWN, NJ 07960
 Phone: +1 (973)-425-0769 Fax: +1 (973)-425-0762 E-mail: info@gagsf.com



www.growermetal.com



Ivor Healy

Where the idea of Fasteners came from.

BEACON FASTENERS AND COMPONENTS

198 West Carpenter Avenue, Wheeling, IL 60090

TEL 1-800-669-2658 FAX 847-541-1789 EMAIL sales@beaconfasteners.com WEB www.beaconfasteners.com



BEACON'S CUSTOM-MADE PROGRAMS MAKE IT ALL SO EASY!

Beacon Fasteners and Components has been a family owned and operated leader in the fastener industry for 39 years. Our hard-working team continually strives for excellence and our culture is focused on creating outstanding experiences for every customer and supplier. We are committed to maintaining the highest level of quality on every product we offer while providing value-added solutions.

One way we are a great partner is through our custom program offerings. Whether it is eliminating the need for duplicate quality inspections so parts can go directly into your inventory, or helping you to better handle market fluctuations, we provide programs that will reduce your total cost of ownership and improve your bottom line. For example, Beacon's leading inventory management plan, our VMI Support Program, provides a streamlined approach to your business process and is the best strategy for managing your parts.

How Beacon's VMI Support Program Can Benefit You!

Like you, most distributors offer a VMI program to their customers. Conceptually, there is great symmetry in what distributors offer, but there are considerable differences too. In the end it all comes down to one basic idea, the end user wants their parts available when needed without having to carry large quantities of inventory. By partnering with Beacon, we will support your VMI strategy by developing an inventory plan that provides that same benefit to you.

Here's how it works - We work with you to identify the parts that are a good fit for the program. By evaluating the historical usages, we will develop a customized inventory strategy with our supply chain and keep six to eight months of product on hand, so your parts will be on the shelf and available when needed. We will streamline your procurement process by taking over the responsibilities of sourcing, stocking and replenishments. This inventory management plan will alleviate you of these daily activities, so you can focus your time, money and resources on other value-added tasks reducing your total cost of ownership.



Just imagine what you will save with one of our custom-made programs. Let Beacon be your solution and talk to your Beacon sales representative today!

What's New at Beacon?

We are excited to announce we have expanded our capabilities and now offer custom bagging and small pack solutions! Let us save you time and money by supporting your packaging needs and meet your specific requirements for a small or high-volume job.

And if you haven't heard we are now stocking high salt spray black zinc thread forming screws! These handsome screws have solid coverage with excellent corrosion and abrasion resistance. With a minimum 96 hours to white rust and 120 hours to red rust they can be used in place of hexavalent black as well as black oxide with added performance benefits. Better yet, parts are available off the shelf! Give us a call and prevent rust and corrosion today.

Beacon has the largest inventory in North America of quality driven high-performance screws with a focus on Thread Forming, Thread Cutting, SEMS, High-Low Tapping, and Metric Screws, plus complementary sizes of Sheet Metal Tapping as well as Specialty Cold Headed Fasteners.

Beacon. The Partner to World Class Fastener Distributors. ●

*Eddie spent the evening wowing Elaine with big talk
about all Beacon's
amazing supply
chain solutions.*

Works every time.



 *Oh Eddie, you're terrible!*

But we get it. Because at Beacon we understand you have specific goals and objectives when it comes to managing your business. And after learning how your business operates, we can build a custom-made program that provides value-added solutions to meet your exact needs. That's a pretty attractive idea.

Inventory Managed Program

We can help cut your overall inventory investments without sacrificing product availability through one of our custom solutions. We offer stock and release, inventory allocation and customer designed VMI Support Programs.

Ship to Stock Program

We can lower your costs associated with receiving and inspecting parts. Rely on Beacon's comprehensive quality validation process and eliminate the need for duplicate inspections so parts can go directly into your inventory. We can supply you with complete documentation including certifications, inspection reports and performance test results.

Price Management Program

We can save you time and resources by constructing a long-term pricing agreement so you can better manage market volatility. Let us increase your speed to market and reduce your time spent on product sourcing by removing steps from your buying process.

VMI Support Program

This leading inventory management approach will reduce your total cost of ownership by streamlining your procurement process. We will design a customized inventory plan based off your shared usages to maintain appropriate stock levels, so YOUR parts will be on the shelf and available when needed.

The Partner to World Class Distributors

**Beacon**[™]
FASTENERS AND COMPONENTS, INC.

SPIROL®

Since 1948!

Coiled and Slotted Spring Pins



- Largest On-Hand Inventory of Standard Spring Pins
- Available in Carbon and Stainless Steel
- Dedicated Customer Service Representatives for Distributors
- Bulk and Small Pack Pricing
- RoHS and DFARS Compliant

IATF 16949



eCommerce for Coiled Spring Pins
Quick • Easy • Convenient • Safe Visit Shop.SPIROL.com



SPIROL.com P 800.321.4679 F 860.774.0487

NORTH AMERICA • SOUTH AMERICA • EUROPE • ASIA/PACIFIC

distributornews

Innovative Components

Inc's Schaumburg facility has recently achieved the ISO 9001:2015 certification. This certifies that they are following strict process guidelines regarding the manufacturing of their products.

This is the second ISO 9001:2015 certification that Innovative Components has received, previously achieved at their Costa Rica location earlier this year.

This certification is important in creating a culture of continuous improvement and evidence based decision making as well as better process integration which leads to overall improvement of customer satisfaction.

For 25 years, Innovative Components has been the leading manufacturer of Plastic Clamping Knobs, Quick Release Pins, Wire Rope Lanyards and Thread Detectives®. Innovative Components capabilities also include Design & Engineering, Custom Injection Molding, Soft Touch Over Molding, Tool Design, Mold Making, CNC Machining, Light Assembly, Bagging, Pad Printing, Laser Etching, Kitting, 3D Printing, 3D CAD, and Secondary Operations such as Slotting, Drilling, Tapping, and More.

For more info, contact *Innovative Components Inc.* by Tel: 847-885-9050, Fax: 847-885-9005, Email: Sales@knobsources.com or online at www.knobsources.com.

distributornews

Innovative Components Inc.

is now manufacturing The Lug Thread Detective®. This device is a precise, portable and easy-to-use thread identifier for both lug nuts and wheel studs. It is also one of the most useful and necessary tools in any mechanic's tool box, tire shop, automotive repair shop, and at home in every gearhead's garage.

Each individual steel identifier is permanently laser etched with the thread size, and features an internal female threaded hole accompanied by a male threaded stud. The inch and metric standoffs are simple to differentiate as the inch identifiers are separated by red impact resistant dividers and the metric with blue. The gliding identifiers are strung onto an extra-

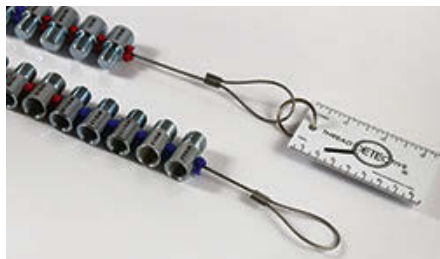

long wire for easy separation. As an added feature the wire starts and ends with a loop for easy hanging while the tool is compact enough to fit most places.

Each unit comes equipped with the common lug nut and stud identifiers in both inch and metric sizes 7/16-20, 1/2-20, 9/16-18, M12x1.25, M12x1.5, M12x1.5, M14x1.50, and M14x2.0.

Start saving yourself time, money, and frustration and purchase a Thread Detective® today. *Additionally....*

STAINLESS STEEL FASTENERS



World class customer service. All American value.

Brikksen is the master distributor of the highest quality stainless steel fasteners in the industry. For more than a decade, we have offered value-added service and superior products. We provide distributors with industry leading customer service, exceptional quality control and unequaled product delivery scheduling. Experience the best.

EXPERIENCE THE BRIKKSSEN DIFFERENCE.

**A Full Line of Stainless INCH (304/316) & METRIC (A2/A4) in stock.
Distribution Sales Only.**

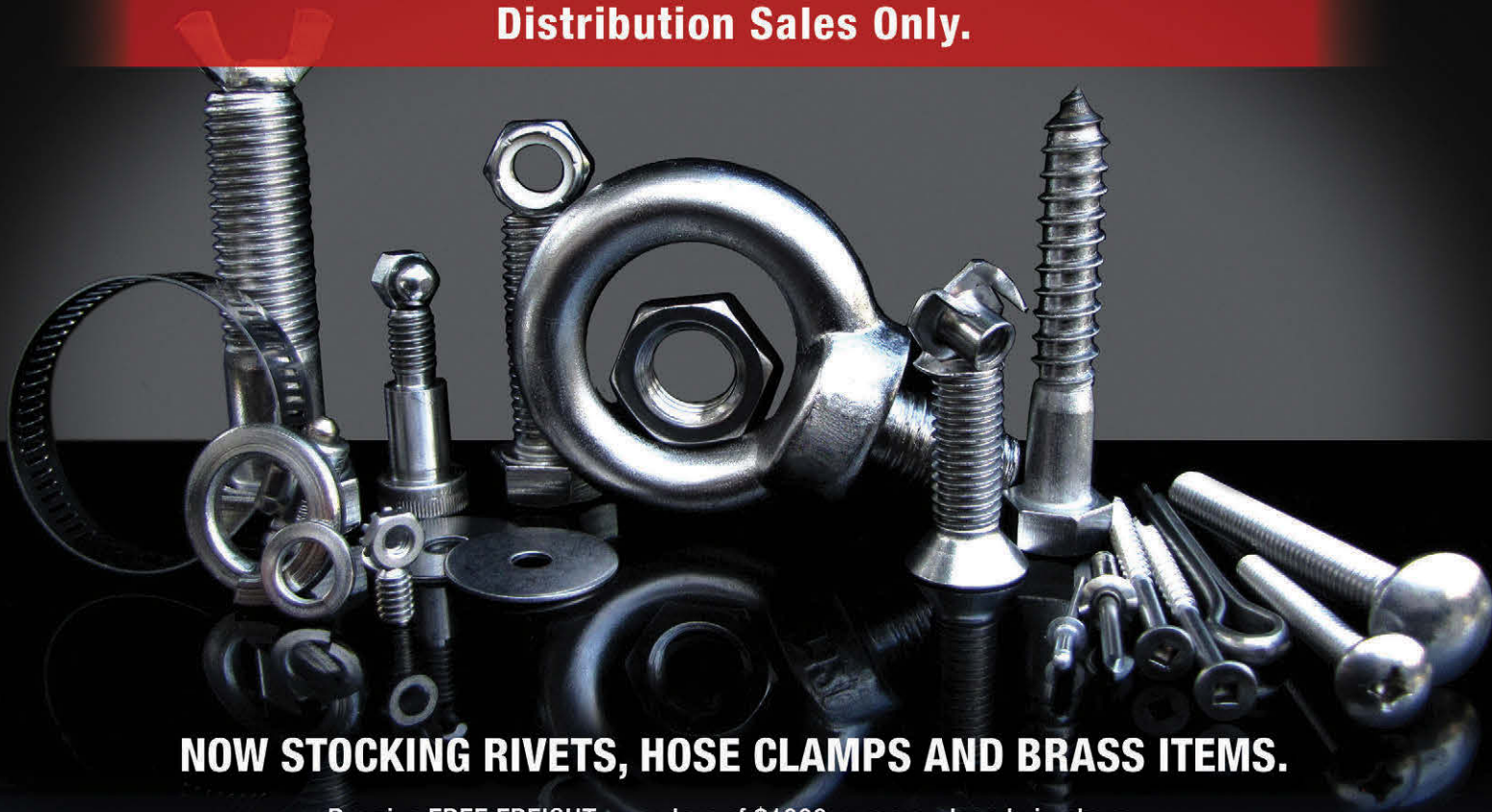

NOW STOCKING RIVETS, HOSE CLAMPS AND BRASS ITEMS.

Receive FREE FREIGHT on orders of \$1000 or more placed via phone, fax or email. Receive FREE FREIGHT for online orders of \$750 or more.

STOCKING YOUR STAINLESS STEEL FASTENER NEEDS IN MULTIPLE LOCATIONS ACROSS THE COUNTRY

1.800.962.1614 | Brikksen.com

Monday thru Friday - 8am - 6pm EST | Fax: 321.233.8665

BENGT BLENDULF SCREW THREADS – A SOURCE FOR CONFUSION AND CHAOS from page 8

His thread profile was originally with a top angle of 53.1° (or 53°8'), where the height was equal to the triangle base, which he later realized was not very practical for blue prints and production, so he changed it to 55°. Our own US thread-hero, William Sellers (no relation to Peter), managed to throw another "curve-ball" into the game in 1864 by introducing 60° thread angle for USST (United States Standard – should have been Sellers- Thread). The 60° thread profile was then suggested by Mr. Sauvage of France in 1891, but with (of course) metric sizes followed by the Germans with DIN 13 in 1919. Now we have a real thread chaos!

The following is a partial listing of other thread types that are, or could still be around, to make our lives even more exciting:

THREAD PROFILE	NAME	USE
45°	Muir	Instruments
47 1/2°	Thury, B.A., Bodmer	Fine Mechanics
50°	Progress, N.H.S., SF	Fine Mechanics
53°8' (53.1°)	Puteaux, Löwenhertz, Old W	Instruments
55°	Whitworth (W), Optic	General Engineering
55°	Whitworth	Pipe Threads
60°	ISO, ASME, NM, USST, SI	General Engineering
60°	NPS, NPT, NPSL, NPSM, NPSH, NPTF, NPSF	Pipe Threads
64° (29+35)	Cordeaux	29° Pressure Flank

ALSO, FOR SPECIAL APPLICATIONS:

29°	Acme	Movements
30°	ISA	
30+3°, 30+5°	"Saw threads"	
45°	"Saw threads"	
52° (45+7)	Buttress	Low Radial Loads
Rectangular	Several types	Movements
Round	Several types	Rail Road, mining
Edison	E5, E10, E14, E16, E22, E27, E33, E40	Light Bulbs

There are also a large number of other thread types that we are not likely to come across. But, there are still

many pieces of older machinery and other equipment in operation around the world that may have parts like fasteners not conforming to today's standards. For industrial suppliers, like fastener distributors, it is important to be able to identify the types of threads used on replacement parts. Mis-matches can be very costly and even dangerous.

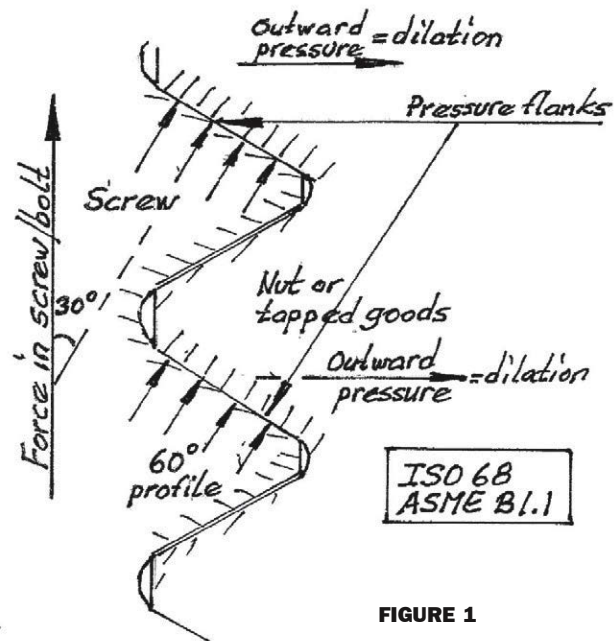
**FIGURE 1**

The 60° thread profile, ISO 68 and ASME B1.1 (B1.1M for metric) is easy to manufacture, specify and use. This profile, however, (like some others) will cause an outward pressure on the internally threaded part (nut or tapped material). This can cause dilation or widening of the nut or part primarily around the first few engaged threads. This is where the highest stresses between the external and internal threads are located.

Typically, the first engaged nut thread takes about 30-35% of the entire load, the second about 25% and then gradually less for the subsequent threads. The current nut standards (heights and materials) have been revised to lower the risk of thread stripping due to dilation and the uneven loading of the threads. As long as we make sure that the correct nut class/grade is used with the bolt, we should have good results. You will notice that there is a 30° angle between the bolt axis (preloading direction) and the pressure flanks.

Build Monster Products

With Unicorp Electronic Hardware, Fasteners & Handles

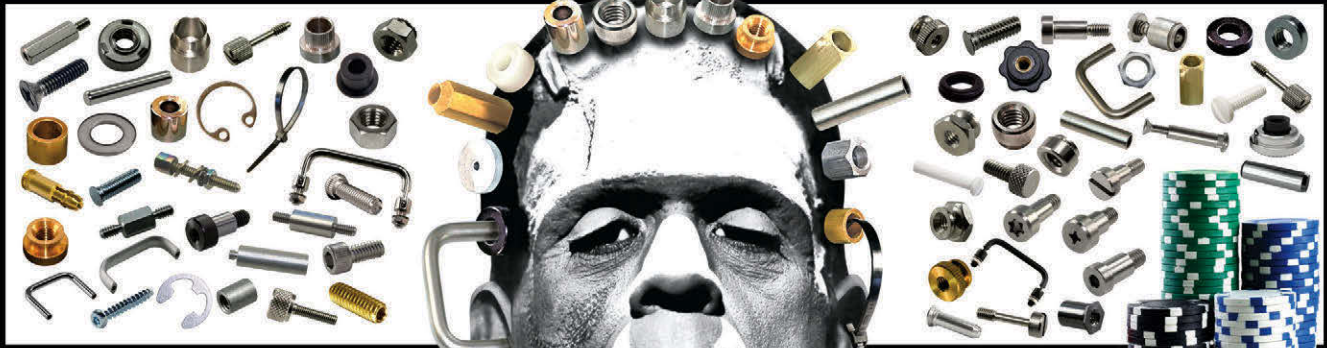

Manufacturer Of
Electronic Hardware
Fasteners & Handles

973 674-1700

(800) 526-1389

sales@unicorpinc.com

VISIT
UNICORP
IN

Las Vegas

MANDALAY BAY CONVENTION CENTER

THE INTERNATIONAL FASTENER EXPO 2018

Oct. 30 - Nov. 1 2018 Booth #3558



UNICORP

www.unicorpinc.com

Light Construction Fasteners • Mill Shipments • Fast Quotes • Nationwide Services

HIGH QUALITY & SERVICE SETS US APART



INTERFAST GROUP

THE PROFESSIONAL'S CHOICE™

www.interfastgroup.com

2730 E. Philadelphia St. Ontario, California 91761 Toll Free: 1-800-605-1233 Fax: 909-930-2183

SPACE CITY SCREW & MFG.

21101 McClain Road, Conroe, TX 77306

TEL 281-689-1081 EMAIL sales@spacecityscrew.com WEB www.spacecityscrew.com



25 YEARS OF SERVICE AND TRUST

Our business has been built on a foundation of service and trust for the past 25 years, dedicated to the manufacture of specialty parts in exotic materials, primarily short-run and smaller quantities, with sales strictly limited to fastener distributors and supply houses only.

Company president Bill McClain, a veteran of the bolt and nut business in the greater Houston area since 1970, sums up the company philosophy as follows:

“We have the greatest sales force in the country, the hard working men and women of our nation’s fastener distributors who bring in the requisitions and requirements of their industrial accounts.”

The “specials” may only make up a small percentage of the overall bill of material involved, but the dollar value can be surprising, with many of the high nickel alloys now reaching the \$20 - \$30 range per pound. We have one of the most comprehensive inventories in the country for exotic materials, which translates to quicker deliveries for the finished product for shipment to you and your customer, which can sometimes be the deciding factor in itself.

We have noticed a recent trend toward the “duplex” and “super-duplex” grades of material. Our current material inventory now reflects not only 2205 duplex, but also Zeron 100 and 2507, along with AL6XN, Ferralium 255, and other, more obscure types, such as 254-SMO.

One of the most popular materials over the last decade has been 17-4 PH, a precipitation-hardening stainless steel that can be heat treated to several different strength levels, the most commonly used being condition H-1150, although we do offer the H-900, H-925, H-1025, H-1075, and H-1100 treatments as well. Our advertisement does not list all the different materials and services we offer to our customers. The large technical library we have amassed over the decades is a real time-saver also, even in the age of the world-wide web. Familiarity with the specifications involved is something you can count on from our knowledgeable technical staff.

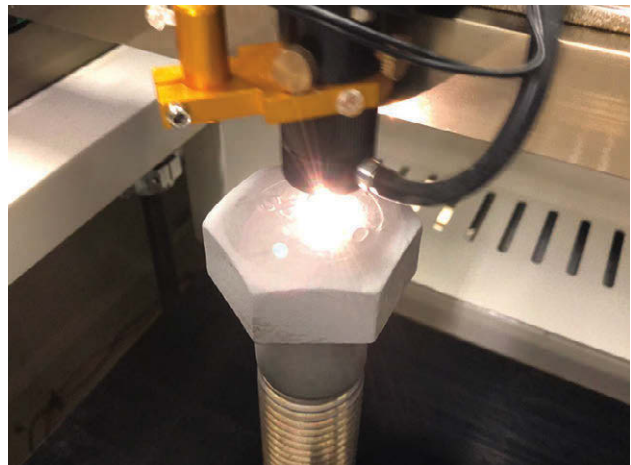

LASER ENGRAVING BOLT WITH LOT NUMBERS

Our ISO program has been in place since 2001, and we are currently certified as an ISO 9001:2015 registered company. Our ISO records track our “on-time and accurate” shipment level over the last 18 years at an astounding 99.9%. This can be translated into bigger profit margins for you, the customer, as the product is delivered on schedule, inspected and correct the first time instead of causing costly delays.

Any documentation your job may require is furnished along with the shipment or via e-mail. With the recent drift towards ROHS compliance, we are now able to also offer this certification for most items that we produce. In addition to the conventional methods of product marking, we recently have added laser stamping and engraving to insure a permanent, legible identification for full traceability, even on the smallest of product that we manufacture.

Every person we communicate with has a set of criteria that makes them unique. Experience our “fastener acumen” for yourself, born of years of dealing with unique individuals and situations. Next time a special part crosses your desk, think “Space City”. We have the tools available to turn special products into profits for your business. ◉

Available Exotics

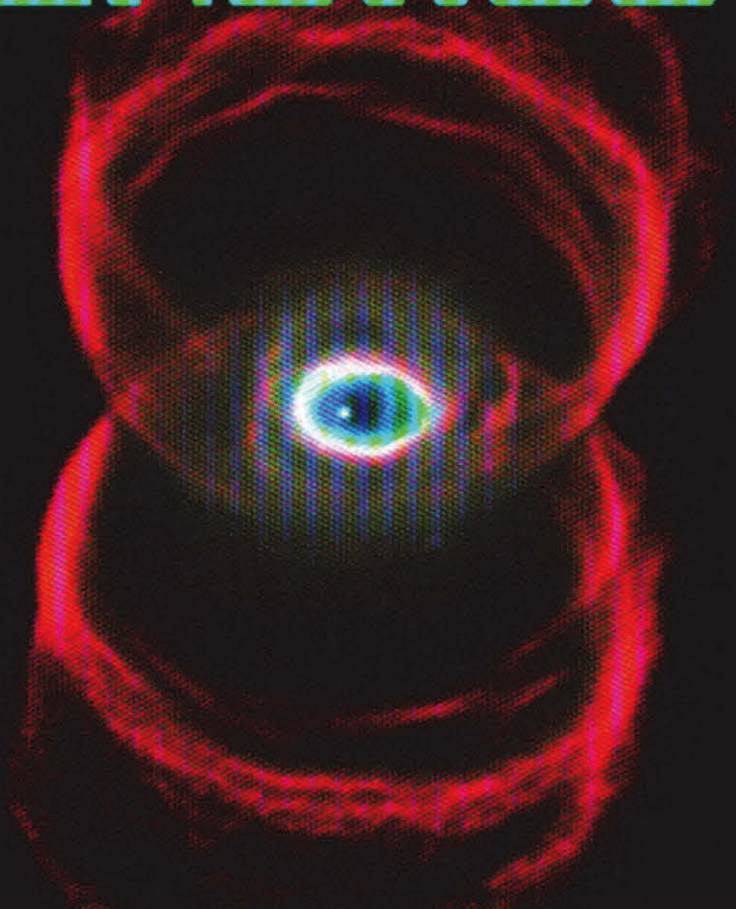

First Class Quality • Fast Delivery
Mill Test Reports • Full Traceability
Parts Made to Order in All Materials
ASTM, ASME, AISI, IFI, ISO, SAE, UNS, NACE

(Hourglass Nebula as photographed by the Hubble Space Telescope)



SPACE CITY SCREW & MFG., INC.

21101 McClain Road • Conroe, Texas 77306

Tel: (281) 689-1081 • Toll Free Tel: (866) SPACITY

Fax: (281) 689-1086 • Toll Free Fax: (800) 545-1365

sales@spacecityscrew.com • www.spacecityscrew.com

17-4PH
20CB3
254-SMO
304-L
309
310
316-L
317-L
321
330
347
410
904-L
A-286
AL6XN
ALLOY 20
ALUMINUM
B5
B6
B6X
B7
B7M
B8
B8M
B16
HASTELLOY
INCOLOY
INCONEL
L7
L7M
NICKEL 200
NIMONIC 80-A
TITANIUM
ZIRCONIUM

After the threads are roll formed, special care is exercised in handling, as the fastener is relatively soft and susceptible to thread nicking damage. Therefore, it is desirable to minimize the amount of handling and tumbling of large diameter fasteners. Contract heat treaters will use either batch loading, or a continuous furnace belt loader. Many in-house bolt manufacturers use the continuous furnace process.

Heat Treating

There are two basic methods of batch heat treating; basket, or 'pusher' and belt loading. The basket method employs placing the fasteners into a large titanium or stainless steel basket. Here, the fasteners remain at rest in the basket which is then slowly pushed through the multiple oven zones. Multiple zones are used to accommodate other following baskets for a continuous flow of products. The fasteners remain stationary in the basket during the full heat-treating process.

The other method is a continuous furnace belt loader. Here, the fasteners are dumped from a tote into a hopper, where they tumble onto a moving belt. The belt and fasteners journey through several heat zones and will then dip into a quenching media, followed by the tempering ovens.

Special care is exercised in the handling of the fasteners when they arrive from the bolt makers because they are called 'green' fasteners; they are relatively soft and very susceptible to thread nicking damage. Therefore, handling and movement must be minimized to avoid thread nicking. In many cases with larger fasteners, the batch heat treatment method minimizes movement.

The heat treatment of steel is an art and an exact science. It is a delicate process that can in an instant, change the performance of the product without any external indications. That is, it may pass hardness and tensile strength but fail proof load testing or fail in service.

Steel is one of the few elements that can exist in more than one type of crystalline lattice structure, which

is known as polymorphism. If the change in structure is reversible, then it is known as an allotropic change.

When iron crystallizes at 2800°F (1538°C) its lattice structure is a body-centered-cubic (b.c.c. for short). It is also known as a δ -Fe (delta iron). When the iron cools to 2554°F (1401°C) the structure changes to a face-centered-cubic lattice (f.c.c.), which is known as γ -Fe (gamma iron) and at 1670°F (912°C) the structure reverts back to a b.c.c. as an α -Fe (alpha iron).

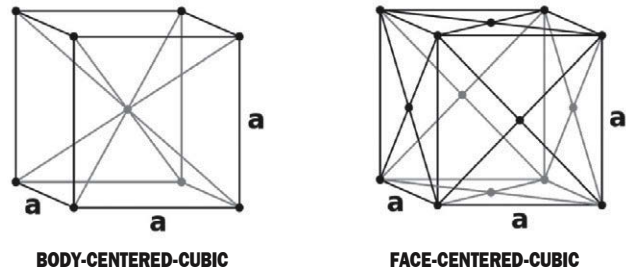

Medium carbon steels are hypoeutectic. An iron-iron carbide equilibrium diagram will indicate the relationships of temperature and carbon to the solubility of iron in different stages: ferrite and pearlite to ferrite and austenite to a full austenitic structure. Also, as temperatures increase, the iron's lattice structure changes from a face centered cubic (f.c.c.) to a body centered cubic (b.c.c.). Cold worked materials should be heat treated more slowly than stress-free materials to avoid distortion.

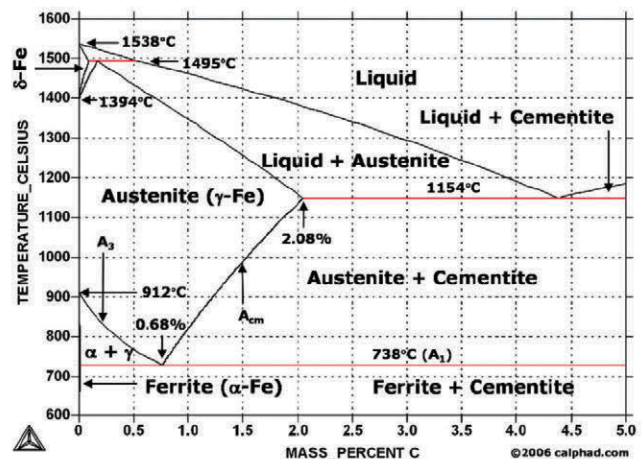

TYPICAL IRON-CARBIDE EQUILIBRIUM DIAGRAM



UNIQUE INDUSTRIES, INC.

tel 205.668.0490
 fax 205.668.0431
 PO Box 683
 Calera, AL 35040
 sales@uiind.com
 www.uiind.com

- large stock of standards available for immediate delivery: anchor bolts, round u-bolts, wilson anchor sleeves, etc.
- materials: carbon and stainless steel, alloys, copper and aluminum
- dimensional capabilities: 3/16" - 4 1/2", lengths up to 60'
- let Unique Industries produce your custom fasteners in the size, shape, material and finish you need
- 100% traceable



MANUFACTURER OF SPECIALTY THREADED ITEMS

OVER 27 YEARS EXPERIENCE IN THE FASTENER INDUSTRY

Rack-Spray Coating Solutions for When Dip-Spin Is Not an Option

Not every part is suited for a bulk, dip-spin coating application. Although pricing may look great initially, the cost of poor quality can quickly add up.

We specialize in medium to high-volume rack-spray applications on parts that require "soft touch" processing, eliminating the need to sort for bent parts, damaged threads or parts stuck together. In most cases, ***we can also turn orders in just one to two weeks*** after initial receipt of product.

We proudly apply



Be sure to visit us at the International Fastener Expo in Vegas, Booth # 2637



THE DECC COMPANY
 Your Rack-Spray Coating Specialist



WASHERS



U BOLTS



STUD BOLTS



V BOLTS



OVERSIZED

1266 Wallen Ave
 Grand Rapids, MI 49507

616-588-2850

SALESGROUP@DECC.COM

www.DECC.com

JOE DYSART IN RECRUITING, AI GETS REAL FOR FASTENER DISTRIBUTORS *from page 12*

Like Robot Vera, it can make hundreds of calls per minute. And it uses voice recognition technology to 'talk' with job candidates and fill them in on details about your job opening.

The system can also be programmed to use facial recognition – combined with predictive analytics – to screen for the personal characteristics you're looking for in an employee.

Videos of select interviews can then be sent to whomever's doing the hiring at your fastener distributor firm for final review and action.

- **Mya** (<https://hiremya.com>) Similar to VCV AI and Robot Vera, Maya chats up people applying for jobs at your company – as well as passive hires who look like good prospects.

After screening and qualifying, Mya sends its picks to your company's Applicant Tracking System, along with a transcript of its interviews with the promising candidates it has found.

- **Entolo** (<https://www.entolo.com>) The key component of Entolo's software is an AI-driven Web crawler, which looks into every nook and cranny of the Web - including LinkedIn, Facebook and Twitter – to find candidates that match the kind of people fastener distributors are looking for.

It also automatically sorts, analyzes and ranks a person's fit for an open position across several attributes, including job title, work history, skills, likeliness to leave their current role and more

Promising candidates are also directly contacted by Entolo – either automatically, or on a schedule designed by the person doing your hiring. And its follow-up messaging helps ensure you stay in contact with your most promising prospects.

- **Google Hire** (<https://hire.google.com>) Already a popular recruiting program, Google Hire got an AI upgrade in 2018 that helps eliminate many of the repetitive tasks associated with the hiring process.

Google Hire's AI, for example, can be programmed to highlight the skills your fastener distributorship is looking for in the resumes that are submitted to your company.

It can also help automatically schedule interviews with promising candidates.

- **ZipRecruiter** (www.ziprecruiter.com) One of the largest online employment marketplaces in the U.S., ZipRecruiter AI component can be used to surface the most promising candidates on its board.

The feature works by studying how employers rate the people applying for work on ZipRecruiter. Generally, people who apply for any and all jobs on the jobs board are very likely to get a 'thumbs down' rating from the employers who use the service – so the system eliminates such candidates from serious consideration.

Next, candidates who get a 'thumbs up' from employers using the board are studied for the traits, skills and characteristics they exhibit – insights that ZipRecruiter uses to recommend candidates with a similar profile.

- **Pymetrics** (www.pymetrics.com) Pymetrics is a specialized AI HR tool that enables fastener distributors to assess the character and skills of prospective employees via games it furnishes candidates to play.

Pymetrics designs those games by inviting your existing, most successful employees to play its neuroscience games, and then gleans data on their traits and strengths based on the way those employees play those games.

Subsequently, Pymetrics uses that data to judge potential hires who

play the same games, looking for people who have the same traits and characteristics of successful people who already working at your fastener distribution firm.

- **Arya** (<https://goarya.com>) Arya takes a similar approach to AI hiring by studying the traits, skills and characteristics of employees you consider to be the most successful and then crawls the Web for job candidates with similar profiles.

The program also gets smarter over time about the people you're looking for by studying the performance of your existing employees based on their performance reviews, the speed at which they're promoted and the length of time they stay at your company. 



ABOVE: UNENCRYPTED WEB SITES WILL BE BRANDED WITH THIS WARNING IN THE GOOGLE CHROME BROWSER COME JULY.

BELOW: AI RECRUITING TOOLS WHICH OFTEN PLACE HEAVY PERFORMANCE DEMANDS ON EVERYDAY COMPUTERS -- WILL BE ABLE TO RUN MUCH FASTER ON THE NEXT GENERATION OF COMPUTERS -- QUANTUM COMPUTERS -- LIKE THIS EXPERIMENTAL QUANTUM COMPUTER AT IBM.

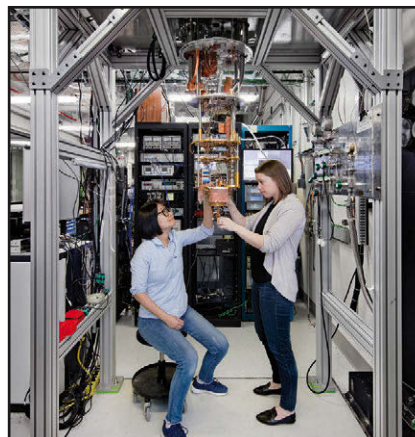

SATISFIED CUSTOMERS AT EVERY TURN.

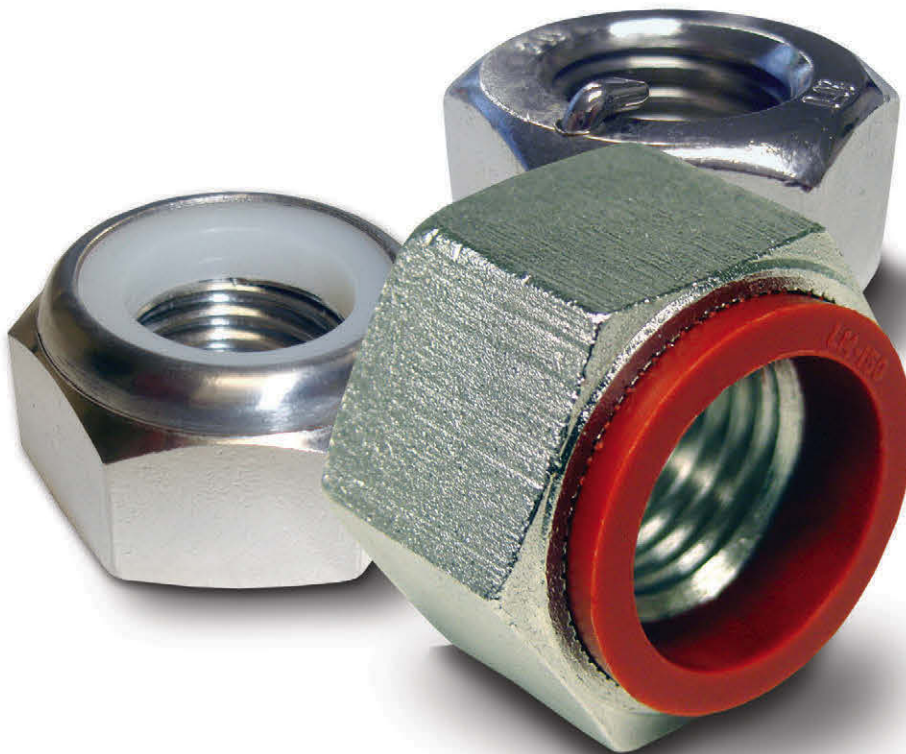

Quality-assured American-made locknuts at a competitive price.

The result of our commitment to product quality, combined with competitive pricing and outstanding service is high customer satisfaction – the very foundation of our business. From our plant in Mansfield, Texas, we manufacture the industry's broadest selection of locknuts with 20 different styles that range in size from machine screw to over 6" in diameter. We utilize an advanced QC program, ensuring the quality of our American-made locknuts. Product availability is outstanding, as well. We carry a large inventory, so we can meet your immediate needs when others can't. When the highest quality in locknuts is required, turn to Lok-Mor.

Lok-Mor, Inc.
Made in America. Made Right.

LAURENCE CLAUS THREE THINGS THAT DISTRIBUTORS MUST DO WELL - PART 2: QUALITY *from page 14*

We also know from experience that that on Day 3 or Day 7 the fruit is still edible but not as satisfying. On Day 3 the banana is still a little green and chalky in consistency and on Day 7 has some small brown spots forming and is a little mushy in consistency. Therefore, even though Day 3 and Day 7 are “in specification”, they do not provide as much satisfaction as the fruit does on Day 5. On Days 2 and 8 the banana is outside of specification and likely inedible.

I believe this is a better picture of the essence of quality. Quality is getting as close as possible to the ideal target value which will provide the customer or consumer the greatest level of satisfaction. It is this last concept, that quality and satisfaction are integrally intertwined, which emphasizes to us the importance of getting quality right.

When Quality Problems Occur

So what happens when we fail to satisfy our customers? Essentially two outcomes occur, our customers lose confidence in us and our organizations are subjected to a monetary loss. In the best case scenarios we only experience minimal impact to both these areas. In the worst case scenarios we experience significant impact on both fronts, even to the point that we lose our impacted customer.

First let's consider the monetary impact of poor quality. Many proactive organizations seek to understand this phenomenon and engage in monitoring and measuring processes. Although a lagging indicator, they do this by measuring the “Cost of Poor Quality”. This measurement seeks to keep track of all the costs and money spent to remedy poor quality situations. This measure would, therefore, include items like rework, sorting, overtime, premium freight, labor for all non-preventative quality assurance activities, and about a dozen other categories. The cost of these activities are collected, summed, and then compared to the total revenue or turnover achieved during the measuring period. Therefore, for every 1% cost of poor quality, an organization spends or wastes 1% of the hard earned dollars received from sales. Take for example, a company that has one million dollars of turnover in a month's period. If their cost of poor quality was determined to be 1%, they have failed to realize their

maximum potential on those sales because they have engaged in wasteful, redundant, or unnecessary activity to the tune of ten thousand dollars.

Sadly, studies have found that organizations operate between a 5% and 30% cost of poor quality. This means that even the best organizations in the world are operating in the 5% range. In that case, if the example company above were best-in-class they would have actually wasted fifty thousand dollars as a result of poor quality. Distributors, many of which operate at thin margins, can quickly appreciate the importance, therefore, of keeping their cost of poor quality as low as possible.

The other monetary eye opener is the ramifications of a significant quality spill. Take for example the discovery of a hydrogen embrittlement failure in a lot of parts sent to an important customer. These spills are rarely small in scale, if for no other reason than the customer becomes extremely concerned about past and future product shipments and often overreacts, causing the resolution costs to spiral out of control and increase like a wildfire fanned by an ever intensifying wind.

Another imperiling event is a product recall. Even a recall small in size is likely to produce eye-popping bills. The attention placed on an organization is never flattering and the resources required to work through the issue are consuming, especially for smaller organizations. Many organizations have been known to seek protection from going out-of-business after being hit with a product recall.

As lousy as this picture seems to be, it is probably not as acute the damage that poor quality reaps on an organization's reputation. The problem with reputation damage is that customers vote with their feet and punish suppliers by either refusing to grow new business for a period of time or leaving permanently. Once the business is lost, it is usually lost forever.

Let me share a personal story illustrating this very point. I was born with a dairy allergy, so that I grew up being constantly “reminded” not to eat this or that sort of food. Like millions of other kids, I loved McDonald's French fries and hamburgers. My brother and I couldn't wait to earn a trip to the Golden Arches. As I got older I graduated from a kid's hamburger to an adult sized hamburger.

AB AMERICAN BELLEVILLE™

The Clear Choice

With over 50 years' experience developing successful fastener distribution partnerships, our mission is to be recognized as the conscientious leader in the industry, by being best at what's most important to you.



LES RIGA
LRiga@AmericanBelleville.com



PERRY BLOSSOM
PBlossom@AmericanBelleville.com

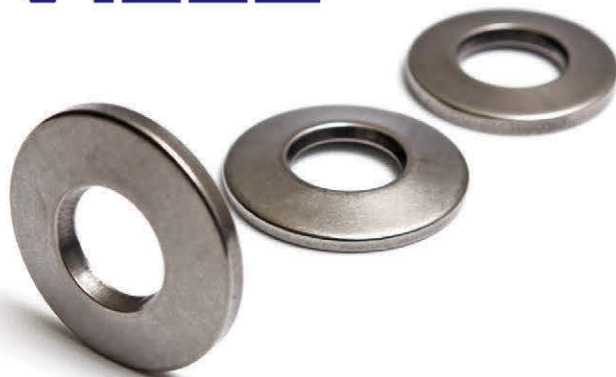

TEL 440-721-8350

www.AmericanBelleville.com



BELLEVILLE WASHERS | DISC SPRINGS | FLANGE WASHERS | PRECISION COMPONENTS

FASTENER TRAINING INSTITUTE®

5318 East 2nd Street #325, Long Beach, CA 90803 TEL 562-473-5373 EMAIL info@fastenertraining.org WEB www.fastenertraining.org

FTI LAUNCHES ONLINE LEARNING LIBRARY by Jo Morris, Marketing Director

The first element of FTI's on-demand web-based learning program is now available. We've captured over 30 of our most popular fastener product training webinars that now can be viewed on-line, anytime at your convenience. This gives you and your staff the ability to learn at your own pace and when time permits.

Web-based learning is both cost effective and convenient. Each FTI produced 90-minute product training webinar consists of 60 minutes presentation plus 30 minutes of questions and answers, captured at the original airing. We'll also include bonus reference material and quizzes.

All FTI classes are presented by recognized fastener industry experts with real world knowledge and experience. Content-rich subjects range from our 3-part fastener basics to understanding hydrogen embrittlement

in fasteners.

The Fastener Training Institute's core purpose is to enhance fastener use, reliability and safety. By providing fastener product and technical training at all levels, FTI can achieve its goal of strengthening the industry and its personnel in all segments.

The objective of the Fastener Training Institute is to elevate the level of technical understanding and expertise of individuals in the fastener industry by providing a variety of training programs presented by recognized industry experts. FTI provides beginning and advanced training on fastener products, standards and specifications.

For more information or to review our video library please visit www.FastenerTraining.org or contact Jo Morris jom@FastenerTraining.com for subscription or corporate pricing options. 



XL SCREW CORPORATION

AMERICA'S FINEST QUALITY IMPORTED THREADED FASTENERS SINCE 1968



The Name You Can Count On

With over 13,000 imported products in stock and our Mill Division that is second to none, we will continue to prove why XL has earned the reputation as the most trusted name in our industry.



Celebrating 50 Years of Quality & Excellence

Our Service Speaks Volumes



GRADE 5 & 8 DOMESTIC CAP SCREWS [USA] GRADE 2, 5 & 8 CAP SCREWS SOCKET PRODUCTS LAG SCREWS TAP BOLTS CARRIAGE BOLTS STEP BOLTS ELEVATOR BOLTS FRAME BOLTS TIMBER BOLTS HEX BOLTS WASHERS FOUNDATION BOLTS B7 HEAVY HEX BOLTS B7 STUDS PINS THREADED RODS ANCHORS CONCRETE SCREWS PLOW BOLTS FLANGE SCREWS SHEET METAL SCREWS MACHINE SCREWS TYPE U DRIVE SCREWS DRYWALL SCREWS THREAD CUTTING SCREWS THREAD ROLLING SCREWS POLE BARN SCREWS THUMB SCREWS GROUNDING SCREWS FLOORBOARD SCREWS NUTS SPRINT POINT SCREWS SELF DRILLING SCREWS SEMS WOOD SCREWS DOCK HARDWARE HDG PRODUCTS METRIC PRODUCTS STAINLESS STEEL

Providing high performance plastic solutions for your prints, parts and engineering problems for 45 years.



 **craftech**[®]
INDUSTRIES, INC.

8 Dock Street
Hudson, NY 12534 USA
P: 800.833.5130
F: 518.828.9468

info@craftechind.com
www.craftechind.com

CARMEN VERTULLO WHAT FASTENER SUPPLIERS NEED TO KNOW ABOUT CALIFORNIA'S PROPOSITION 65 *from page 24*

It only matters if the chemicals are in sufficient quantities and there is an exposure mechanism that gets the chemical into the Californian. The typical exposure mechanisms are ingestion, dermal exposure, inhalation and intravenous. For fasteners, touching the item, thereby transferring some of it onto your fingers and then onto your food which is then ingested would be the typical exposure mechanism.

As you can imagine, the amount of any substance you can actually ingest in this manner is very, very small; especially for a solid such as a metal, and especially when the substance of concern is only a few percent or less of that metal. Nevertheless, many other items made of the same metals and with the same coatings as fasteners have become targets for prop 65 enforcement actions.

Prop 65 does not ban any listed substance or chemical. It does not regulate the use of any listed substance or chemical. It does not register the use of any listed substance or chemical. It does not enforce the proposition. It does not provide for surveillance of the use of any listed substance or chemical.

The essence of the Prop 65 problem is not the warnings or the chemicals. It is the enforcement mechanism. Anyone who has knowledge of a Prop 65 violation, real or perceived, can file suit against the supposed violator. This has given rise to an industry of "bounty hunter" law firms who do nothing but sue Prop 65 violators. The news arrives in the form of a 60-Day Notice that reads like a shakedown.

Typical out of court settlements range from \$5,000 to \$100,000.00. There are a few examples that go much higher. Invariably the defendants settle because the cost of defense is much higher than the claim, or as in most cases, they do not have a sound defense. The bounty hunters have plenty of low-hanging-fruit, that is actual violators of Prop 65 to go after. Chances are if you are sued, you are actually guilty.

The law has recently (August 30, 2018) changed, and so after many quiet years it is once again on the fastener industry's radar. Sadly, most analysis of this change from a legal perspective is off-base and some fastener suppliers are panicking into solutions that are ill-advised.

The change does not add any new chemicals to the list. It only changes the warning format requirement and

redefines the responsible parties. The new regulations place primary responsibility for providing warnings on product manufacturers, producers, packagers, importers, suppliers or distributors. That sounds like us so we think it matters.

The new warning requirement is for a specifically formatted message, a triangle-shaped symbol, the Prop 65 website, and the identification of at least one listed chemical. The warnings may take any form, but must be "clear and reasonable". Previously the labels could be generic and simply say the product "contains a chemical known to the state of California to cause cancer or reproductive harm". The new Prop 65 revision provides examples of what kinds of warnings are considered "clear and reasonable."



**EXAMPLE OF A PROP 65
"CLEAR AND REASONABLE WARNING"**

Warnings may take the form of labels on the product, shelf signs, point-of-sale signs, messages on packing slips or safety data sheets. Catalogs and websites also require warnings. There is also a "short form" label format that is considered "clear and reasonable" that may be used only on-product.



**EXAMPLES OF "CLEAR AND REASONABLE" FORMAT FOR
SHORT FORM ON-PRODUCT WARNINGS**

A Successful Finish Starts with UC.



UC Components, Inc. offers a range of finishes for our RediVac® line of fasteners, washers, and nuts, with coatings and platings designed to prevent galling and/or improve the corrosion resistance of the treated component.

UC Components' component finishing processes include:

- Precision Cleaning
- MoS₂ and WS₂ Coating
- Silver and Silver Chromate Plating
- Electropolishing
- Gold Plating
- Anodizing
- Nickel Plating and Nickel-Teflon Coating (KTF Coating)
- Passivation
- Kolsterising®

Call for a free consultation
408-782-1929
 uccomponents.com



Enjoy the reliability of
100%
 NORTH AMERICAN

SPECIAL BOLTS - ANY GRADE UP TO 3/4" X 6"

TANK BOLTS



NEW PRODUCTS
 • INDENTED SQUARE HEAD
 CHIME BOLT

SERRATED FLANGE LOCKING BOLTS



A325 STRUCTURAL BOLTS



1/2" TO 1-1/2" DIAM. FOR ALL
 STRUCTURAL FRAME ASSEMBLIES
 - FULLY THREADED

CULVERT & GUARD RAIL FASTENERS



WE MAKE NUTS - available in carbon steel & 304-316 stainless steel



WE OFFER CUSTOM THREADING



Canadian Threadall, a division of Leland, is Canada's largest custom threader and can offer you a complete variety of quality threaded products in most ferrous and non-ferrous metals.

- Reverse engineered products from broken or failed samples
- Threading up to 4-1/2" cut and rolled thread Thread milling to 16"
- Threaded rods in stock up to 3" diameter in all grades of material
- Bent and formed parts to 4" including "U", "EYE", "J" and "L"



1-800-263-3393
 www.lelandindustries.com

100% North American Made

WHEN IT CAN'T WAIT UNTIL TOMORROW...

Dependability

FOR YOUR CRITICAL ENVIRONMENTS



- Valves
- Pressure Vessels
- Pipelines
- Water Treatment



USA



FASTENER GROUP, INC.

MW Industries, Inc.

Visit energy.mw-ind.com for a full list of capabilities. Call 866-546-587 or email sales@usafgrp.com and one of our fastener experts will be happy to assist you!



MADE IN THE USA

ISO 9001:2015, API 20E-0017, API Spec Q1-2950



distributornews

More than ever, companies are hard-pressed to find ways to save money in both manufacturing and repair settings. One such way is to use wear parts at pivot points, specifically Tension Bushings manufactured by **Vogelsang Fastener Solutions, Inc. (VFS)**. Tension Bushings are hollow cylinders with a full-length longitudinal slot ("wav" or straight), permitting compression and expansion. They protect the structure of low RPM, and low-high impact locations where a shaft is rotating.

VFS Tension Bushings are an excellent cost-saving alternative to solid bushings and can increase the amount of "wear time" between changing existing bushings. Installation is easy in both manufacturing environments and replacements in the field with minimal tools. Chamfers help facilitate pressing these wear parts into a bore without causing damage to the surface of the bore or shaft to which they are fitted.

Vogelsang Fastener Solutions offers same-day shipment on a large variety of sizes in their Quick Ship (QS), stocking program. Outer diameters (OD's) from 3/4" to 3 1/2", and up to 3" in length are available from stock. OD's from 4" to 5" are available for special order, as are Tension Bushings needing grease holes and/or grease grooves.

For more information contact Vogelsang Fastener Solutions, Inc. Toll-free: 1-800-526-2376, Email: sales@vogelsangfastener.com or visit them online at www.vogelsangfastener.com.

DELTA SECONDARY



DRILLING • THREADING • CUTTING

*Offering Fastener Distributors over
35 years of fastener related
machining experience...*

- **Quality Machine Shop
Serving Fastener
Distributors**
- **Small or Large
Quantities**
- **Hard to Find Items**
- **Special Prototypes**
- **CUT OFF & CHAMFER**
- **CUT THREADING**
- **CROSS DRILLING**
- **DRILLING & TAPPING**
- **TURNING**
- **MILLING**
- **SLOTING**
- **GROOVING**



DELTA SECONDARY, INC.
1000 Industrial Drive
Bensenville, Illinois 60106
Tel: 630.766.1180 Fax: 630.766.1285

EMAIL: DELTA911@MSN.COM

Fastener Fair USA is inviting industry professionals to submit proposals to participate in educational sessions scheduled for the show. To be considered, industry professionals should submit a proposal on fastening and fixing technology, innovations, case stories, and solutions by October 15, 2018 using the Speaker Submission form on the Fastener Fair USA website at www.fastenerfair.com/usa/exhibitors/become-a-speaker.

New for the 2019 show, there will be a special area for bonding and adhesive exhibitors. Bonding and adhesives are growing in importance in modern manufacturing. They provide an excellent addition to traditional fasteners and have become a vital choice in lightweight construction, for example in the automotive and electronics industries. This special area will make it easy for manufacturers to discover and evaluate bonding and adhesive solutions that could potentially enhance their operations.

Additionally, Fastener Fair USA 2019 is now moving to the Cobo Center in Detroit, Michigan. Many of the attendees last year came from Midwestern states like Ohio, Illinois, Indiana, and Michigan, but there were also many that traveled from California, Pennsylvania, New York, and international cities.

"We chose Detroit as our next location to stay close to the Midwest manufacturing region but to also bring the show closer to our automotive and aerospace manufacturers," said Boveak. "Detroit offers more travel options for our international visitors, making it easier for them to attend."

Who Should Exhibit?

For exhibitors, Fastener Fair USA offers a unique platform for meeting new and current customers, finding distributors, identifying engineering opportunities, and networking with fastener and fixing industry professionals throughout the entire supply chain.

Last year, 255 exhibitors from 20 countries showcased products, equipment, and solutions requiring 28,500 square feet of exhibit space. Exhibitors were able to connect with customers representing a variety of industries with the top categories including:

- Aerospace
- Agriculture/Off-Highway Machinery
- Automotive
- Construction

- Distribution
- Energy/Power Generation
- Maintenance/Repair

Fastener Fair USA attracted the types of buyers and decision makers exhibitors were hoping to see. The primary job titles/responsibilities of attendees were:

- Buyer
- Department Head/Senior Manager
- Engineer/Technical Specialist
- Managing Director
- Purchaser/Procurer

Who Should Attend?

For attendees, the show offered a first-hand look at the latest fastener/fixing solutions and technology available in the marketplace, networking events to facilitate relationships with peers, and top-notch educational programs developed and delivered by industry experts.

"From what I have seen, it doesn't matter which industry you are involved with, there is something for everybody here," said attendee Charlie McGrady of Jasper Engines and Transmissions. "No matter what you do, you can find contacts, ideas, or suppliers."

More than 2,000 registrants attended the show in 2018, representing 27 different countries. Fastener Fair USA focused on creating a premier event to bring together manufacturers, distributors, suppliers and end users and then delivered on that goal. The types of visitors included:

- Fastener/Fixing Distributors or Suppliers
- Fastener/Fixing Manufacturers
- Fastener/Fixing Users
- Fastener/Fixing Wholesalers/Suppliers to Resellers

"I was very excited to be a part of Fastener Fair USA, especially for its first year, and experienced one of the busiest shows I have been to in years," said Lori Coar, President of Aluminum Fastener Supply Co., Inc. "I'm definitely looking forward to Detroit in 2019 and again exceeding my sales goals at the show."

The next Fastener Fair USA will take place in Detroit, MI at the Cobo Center on May 22-23, 2019.

For information about Fastener Fair USA 2019 or to exhibit, visit the website <http://fastenerfair.com/usa/>, or contact Show Management at fastenerfairusa@mackbrooks.com or 866-899-4728. 

LIPPINCOTT

SUPPLY COMPANY • SINCE 1948

Wholesale Importer and Master Distributor of Threaded Fasteners

Allthread • Nuts • Bolts • Washers • Self-Drilling • Deck • Drywall Screws

Proud distributor of top brands,
including:

FASTAP

RED HEAD

FastenMaster.

707-552-8633
Toll Free • 800-244-1143
Fax • 707-552-3457

105 Lincoln Rd W
Vallejo, Ca 94590

www.LippincottSupply.com
LippincottSupply@sbcglobal.net

Get in touch with a sales rep today
to find out how we can fulfill your
specialty fastener needs.



DALE

FASTENER SUPPLY

U-BOLTS AND INDUSTRIAL FASTENERS SINCE 1959

U-BOLTS - ANCHOR BOLTS - STUDS

O-RINGS - GASKETS - FLEXLOC NUTS - SOCKET HEAD CAP
SCREWS - PIPE PLUGS - SPIROL PINS - PRO-COAT U-BOLT™
SPRING NUTS - WEDGE ANCHORS - SQUARE WASHERS
THREADED ROD - CLEVIS HANGERS - B7 STUDS

U-BOLTS ARE STOCKED

CARBON STEEL - HOT DIP GALV - ZINC PLATED - PLAIN
FINISH - 304SST - 316SST - TEFLON - PRO-COAT U-BOLT™
SERMAGARD™

Unbrako
THE WORLD LEADER

PRO-COAT U-BOLT

SIMPSON
Strong-Tie

FLEXLOC

DALECOMPANY.COM

6216 NAVIGATION, HOUSTON, TX. 77011

24 HOUR SERVICE

Specials are made to order with short lead times

713-928-3437

Sales@DaleCompany.com

RICHARD HAGAN FASTENER COMPANY ACQUISITIONS COMPLETED DURING THE FIRST HALF OF 2018 from page 26



Contractors & Industrial Supply, Inc.

On January 29, 2018, **NEFCO Corporation** purchased **Contractors & Industrial Supply Inc.** ("CIS"). Founded in 1984 and headquartered in Roanoke, Virginia, CIS is a full-service distributor of mechanical, electrical and plumbing supplies to commercial construction contractors. The CIS product range includes fasteners, mechanical supports & struts, anchoring systems, hand & power tools, pipe fabrication tools and power systems, which are delivered to jobsites in a timely fashion. CIS has two branches located in Harrisonburg, Virginia and Greensboro, North Carolina. Founded in 1981 and headquartered in Hartford, Connecticut, NEFCO is a value-added stocking distributor of electrical, mechanical, HVAC and sprinkler products. The company provides its commercial contractor customers with just-in-time jobsite delivery, along with equipment rental, tool repair and engineering services. A privately-owned company, NEFCO operates seven distribution centers in: Boston, Hartford, Albany, New York City, Philadelphia, Washington and Fort Lauderdale. The CIS acquisition expands NEFCO's growing footprint and product solutions offering to construction contractors up and down the East Coast.

Purchase price: not available



On January 30, 2018, **Monroe Engineering Holdings LLC** ("Monroe") purchased

Spangle Fasteners Inc. Founded in 1974 and located in Fort Wayne, Indiana, Spangle Fasteners is a distributor of fasteners, Class C parts and industrial supplies to general industrial customers. Spangle Fasteners carries a full range of fastener products and focuses primarily on the OEM requirements of industrial customers within a 100 mile radius of Fort Wayne. The company's products are used in the manufacture of commercial garage doors, agricultural pumps, equipment trailers and many more. Established in 2011 and headquartered in Rochester Hills, Michigan, Monroe is comprised of three operating divisions: Monroe Hinge & Hardware; Monroe Aerospace; and Monroe Seals. Monroe is a portfolio company of **Shoreview Industries LLC** ("Shoreview"), a Minneapolis, Minnesota-based private equity firm with \$900 million of committed capital under management. Shoreview completed the purchase of Monroe just 60 days prior to completing the Spangle Fasteners add-on acquisition.

Purchase price: not available



On February 2, 2018, **Etanco S.A.S.** purchased the **Inert Technology Fixing** division ("IT-Fixing") of SIT-AB Sàrl.

Founded in 1999 and located in Alsace, France, IT-Fixing is a developer and manufacturer of unique insulation fasteners used to attach heavy metal structures (staircases, balconies, access ramps, etc.) to the facade of a building. IT-Fixing fasteners utilize resin reinforced with fiberglass - along with an injected expansive foam - to reduce thermal bridges and ensure airtightness. Founded in 1952 and headquartered outside Paris, Etanco develops, manufactures and distributes specialty fasteners for the commercial construction market. The company offers more than 80,000 SKUs focused primarily on three construction applications: the building envelope, the building structure and the building interior. Etanco operates five production sites in France (3), Italy and Poland, along with six commercial offices in Germany, Belgium, the United Kingdom, Czech Republic, Poland and Romania. The company generates annual net sales of approximately €195 million and employs 787 people. Etanco is a portfolio company of **3i Group plc**, a London-based private equity firm with £3.4 billion of assets under management. 3i Group shares are traded on the London Stock Exchange (III.L).

Purchase price: not available



On February 16, 2018, **Colony Hardware Corporation** purchased **Allied Fastener & Tool Inc.** ("Allied").

Founded in 1982 and headquartered in Lake Worth, Florida, Allied is a retailer of professional fastening systems, power tools and hundreds of other construction products. Allied supplies construction contractors with numerous branded product lines including DeWalt, Hitachi, Milwaukee, Senco, Powers and many more. The company has three branches in Orlando, Sarasota and Port St. Lucie, Florida. Founded in 1988 and headquartered in Orange, Connecticut, Colony Hardware is a regional distributor of fasteners, power & hand tools, safety equipment and consumable MRO supplies for commercial construction and general industrial customers. The company provides jobsite delivery services, along with equipment & power tool rental and repair services. Colony Hardware operates 20 stores / warehouses in Michigan (7), New York (3), Illinois (2); Ohio (2), Connecticut, Massachusetts, Rhode Island, New Jersey, Pennsylvania and Maryland. Colony Hardware is a portfolio company of **Tailwind Capital Group LLC** a New York-City-based private equity firm with more than \$3 billion of committed capital under management.

Purchase price: not available

ALUMINUM FASTENER

*For over 35 years, Aluminum Fastener Supply Company has been the USA's **only exclusive** aluminum supplier*



IT'S WHAT WE DO.

1-800-526-0341 | info@alumfast.com | www.aluminumfastener.com

 Follow us on Twitter @AluminumFast

ALUMINUM FASTENER SUPPLY COMPANY

4297 CORPORATE SQUARE, NAPLES, FL 34104 TEL: 239-643-4551 FAX: 239-643-5795

COMPUTER INSIGHTS INC. **HOW GOOD IS YOUR USER SECURITY?** from page 34

The security system controls who can see Quantity, Cost and Price information, who can fax and e-mail information. In addition, it has the ability to limit Document Access, Notes Access and Entry & Deletion Access.

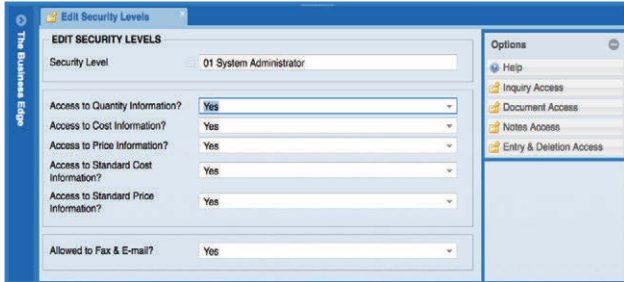

The flags in the Security Level setup contain options that relate to the detailed information that is available after Users are in a particular menu, such as Order & Quote Entry. The first screen below pertains to the values displayed on the screen as well as different Inquiries throughout the system. Inquiries throughout the system do not give the User the ability to change Master File information but the ability to view it. The Inquires in the system are very detailed, all of the open and processed information is available through the Inquiries.

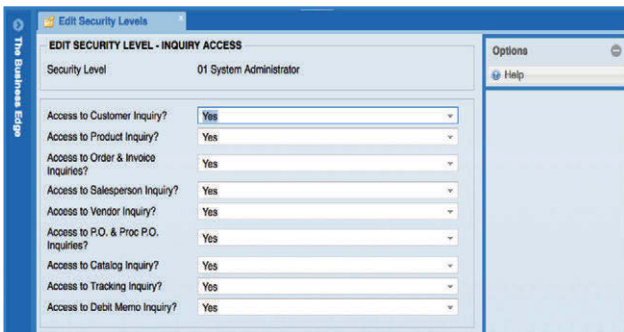

Security Level - Document Access & Output

Throughout the system users have the ability enter, edit and output Orders, Quotes, P.O.s, Invoices, etc. If these flags are set to No for a specific level, they will receive an Access Denied Message if they attempt to enter, change, or fax, or e-mail a document out of the system. Since some users never need this ability, it simply ensures they never accidentally send documents out.

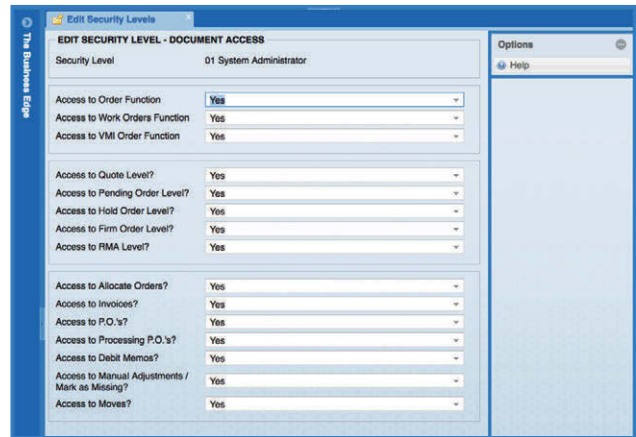

Security Level - Master File Entry & Deletion Access

This screen is available through the Entry & Deletion button. This provides security for entering and editing Master File information and Documents in the system. Once a Customer Product or Vendor has history, Users cannot delete them. Initially if no history is imported, you run the risk of an employee accidentally deleting a record if the access is set to yes on this screen. Entering Customers, Products and Vendors is available through the File Maintenance areas in the system as well as through the Master File option on the Tool Bar.

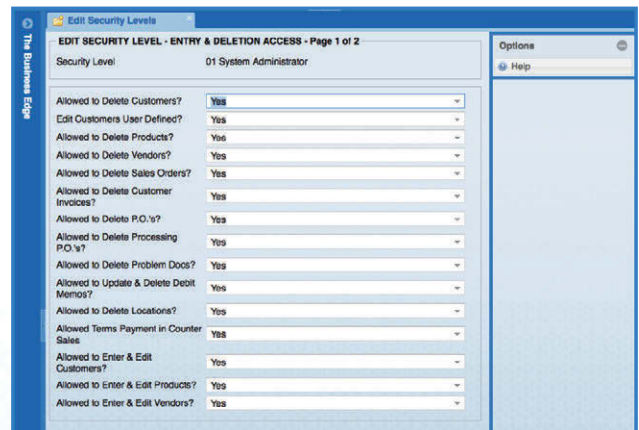

There are similar limitations on costs and prices.

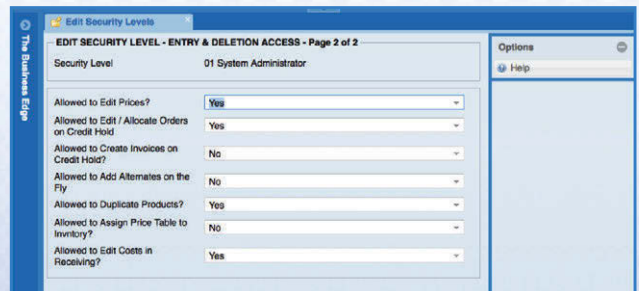

distributornews

Intercorp, an importer and master distributor of professional grade construction fasteners under the Strong-Point® and Strongcon® brands, is pleased to announce their new Strong-Point Razor fastener. This highly engineered product will attach light gauge sheet metal to sheet metal in HVAC applications or any light duty steel attachments.

"Intercorp spent endless hours of R&D on this design because we wanted to give our customers a product that has the potential for very high demand and the engineering to help users be more productive and efficient on the job," said Law Winchester, National Sales Manager. "To do this, we designed a proprietary point to pierce light gauge metal quickly and prevent walking for faster engagement. We then equipped our new fastener with finer threads to draw sheets of metal more closely together, forming a tighter connection to reduce airflow escape in HVAC applications. We believe that users of this fastener are going to be extremely pleased with the overall performance of our new Razor Point screw."

Founded in 1988, Intercorp has established itself as an industry leader in the fastener distribution business.

High quality parts, lowest possible prices

- Over 80 high speed planetary machines
- 2 fully automated U-bolt machines with capabilities to a 1" diameter
- 34 machines to straighten and cut wire
- 62 machines to thread
- 70 machines to bend
- 3 Cold Forging Machines
- Diameters from 10-24 to 1"
- Carbon Steel—C1018 and C1541
- Quench and Temper to Grades 5, 7, 8, 8.8, 10.9
- Stainless Steel—304 and 316
- Silicon Bronze 651



1.800.979.1921 • Fax 1.800.345.9583
 sales@randengineering.com
 www.randengineering.com



Their flagship brand, Strong-Point, is sold by thousands of distributors to construction professionals throughout the

United States. The brand consists of a variety of professional-grade fasteners including: Self-Drilling, Needle Point, Woodworking, Stainless Steel, Drywall, Pole Gripper, Outdoor, Concrete, and Cement Board screws.

For more information on Intercorp and their Strong-Point® brand of fasteners, contact them by phone at 1-800-762-2004 or visit them on the web at www.strong-point.net.

LORRI HUNT THE ISO 9001 TRANSITION IS OVER, NOW WHAT? *from page 40*

To sustain this requirement on an ongoing basis after the transition is complete, organizations should ensure that the process they used to achieve the initial transition is repeatable. This could be through an annual planning process or incorporating the review in the management review by updating a SWOT (Strengths, Weaknesses, Opportunities, Threats) analysis with the management team.

The review should be evident prior to a surveillance audit by the certification body. It is reasonable that this review would occur once a year or if there are significant changes in the industry where adjustments would need to be made before the annual review. Organizations should consider the best timing for this review. Most likely it will not coincide with the timing of your audit, and this makes sense. To add value to the organization, this review should be integrated into the operations of the business.

While documented information is not specifically required for external and internal issues, organizations may find it helpful to achieve that repeatable approach. Management Review (clause 9.3) requires that changes in the external and internal issues in the organization be reviewed. During the transition period, many organizations have misinterpreted this requirement for the requirement from previous versions of the standard which required the organization to analyze changes in the quality management system.

These two things, while similar, are not the same. One is focused more on the strategic direction of the organization (external and internal issues) while the other is more focused on how the changes might affect the organization (new ERP system). To avoid this potential pitfall, organizations should clearly have the language from the Management Review clause inputs (9.3.1) listed in their management review. This can also be helpful to ensuring that all of the requirements of management review are adequately addressed.

Clauses 6.1.1 and 6.1.2 Actions to address risks and opportunities - This requirement is directly related to the requirement for determining the external and internal issues of the organization (clause 4.1). Once these issues are determined, along with considering the needs and expectations of relevant interested parties (clause 4.2), the organization will need to address the risks and opportunities of the organization. Along with this determination, actions to address these risks

and opportunities will need to be identified as well as consideration of whether the actions were effective or not.

During the initial transition, many organizations took an approach where the identified external and internal issues became the risks and opportunities for the organization. While this approach can be acceptable, organizations should analyze whether the issues always translate to risks and opportunities. Another challenge during the transition was the fact that many times the focus was on the risk of products or services (e.g. failure of products) and did not always address risk that would be related to the management system at a higher level (e.g. availability of employees, shortage of truck drivers for delivery). Further complicating the transition is the fact that while organizations did identify risks, there was little consideration of opportunities.

A frequent method of implementation that was used by organizations to demonstrate the requirement included an analysis that showed the potential of the risk and what actions would take to mitigate it. This analysis frequently did not address the effectiveness of the actions taken to address risks and opportunities. Management Review (9.3.1) specifically requires as an input to consider the effectiveness of the actions taken to address risks and opportunities. Therefore, this was a frequent gap.

To ensure an organization adequately addresses this requirement on an ongoing basis, three steps should be taken:

[1] Identify both risks and opportunities. Use the external and internal issues and relevant interested parties to determine the risks and opportunities. Ensure that there is at least one opportunity. This can be growing the business through additional customers or an opportunity to make improvements through the implementation of technology. Either a SWOT analysis or a simple discussion can be used to demonstrate implementation. While clause 6.1.1 does not require documented information of the risks and opportunities, since management review does require this information, a spreadsheet can be used to ensure that the organization has repeatability of implementation.

[2] Determine the actions taken to address risks and opportunities. Use the SWOT analysis or other method to determine these actions. Include information in the documented information that identifies the actions taken.

Why Bet With Anyone Else, . . .



When You Can Win With *Prestige!*

**Prestige
Stamping,
Inc.**

- ψ Fast Delivery
- ψ Competitive Pricing
- ψ Quality -
 TS & ISO Certified
- ψ Reliable Service
- ψ Modern facility
 105,000 sq.ft.
- ψ Finest Prime Material
- ψ Domestic
 Manufacturers of:
 Type 1 & Type 3
 Structural washer to
 ASTM F-436 Specs.
- ψ Through Hardened &
 Standard S.A.E. &
 U.S.S. Washer
 marked with
 Size Pattern
- ψ Belleville & Conical
 Spring Washers
- ψ Special Flat &
 Wave Washers
- ψ Pre-Assembly Sems
 type Washer

23513 Groesbeck Hwy.
Warren, MI 48089
Phone: 586-773-2700
Fax 586-773-2298
www.PrestigeStamping.com

JIM TRUESDELL INFRASTRUCTURE REBOOT CAN'T WAIT! *from page 44*

Democrats seem to go for more direct federal spending and the big job programs that would automatically follow. Republicans argue that the encouragement of private sector development through tax incentives and grants would be more efficient and have longer lasting economic benefits. But the disagreements are not with respect to the larger goals and the urgent need. These variances can and should be resolved by compromise and not allowed to produce a legislative logjam.

On July 23, the House Transportation and Infrastructure Committee Chairman Bill Shuster unveiled a draft of a discussion plan on the topic designed to further the conversation. In the meantime, legislators are already heading to their home districts to campaign. This means the window has closed on action this year, but the topic is on the table and people should be letting their representatives know that fixing the infrastructure should be a key priority. The need is evident in almost all local areas. Delays and rising maintenance of crumbling

systems are holding the economy back. Safety concerns are raised as bridges and roads are structurally deficient and drinking and wastewater systems raise threats to public health. Our computer and internet-based society needs electrical and broadband avenues to carry an ever increasing load of information. Delays caused by traffic congestion, airport inefficiencies, and port and terminal inadequacies are costing jobs and tax revenue. While we still have the world's preeminent economy, our infrastructure is rapidly falling behind European and Asian countries. Our population has doubled since the 1950's and 1960's when most of these systems were put in place.

Our initial building of infrastructure largely took place in the late nineteenth century which set the stage for America's economic dominance in the twentieth century. Some of these hundred year-old plus sewers, bridges, and water mains are still in service. We are overstretched and in need of prompt action. We simply cannot afford delays! 

JIM TRUESDELL

IFE IFE ANNOUNCES 2018 AWARD WINNERS *from page 54*

INTERNATIONAL FASTENER EXPO

Young Fastener Professional of the Year Award Winners



Peggy Hsieh
Brighton-Best International

Peggy Hsieh is the Chief Operating Officer of Brighton-Best International (BBI) where she oversees the operations and IT functions of all 32 BBI branches across 6 countries. BBI has always been at the forefront of using technology to help the fastener industry reduce transactional costs.

Peggy not only manages the IT department but she tries to engrain technology as a philosophy throughout all BBI departments and the fastener industry.



Jun Xu
Brighton-Best International

Jun Xu is the President of Brighton-Best International (BBI), where he is responsible for the strategy and purchasing for all of BBI's locations across 6 countries. Through his leadership and direction, BBI's purpose and role in the fastener industry has been transformed from selling products to focusing on how to help distributors grow and succeed. Jun not only provides the strategic focus within BBI but also serves as a Board of Director member of the NFDA.

Jun and Peggy have been married and have worked together for over 10 years. They live in Los Angeles and have two children together.

As a reminder, a special recognition award ceremony will take place on the show floor in the Sessions Corner at IFE in Las Vegas, NV on Wednesday, October 31, 2018 from 2:30-3:30pm. 

ISO9001 Registered



Beyond control knobs . . . Components and assemblies within your reach.

EHC, your premier manufacturer of Clamp Knobs, Handles, Ratchet Handles, and Custom Assemblies, has the largest selection of Control Products and Industrial Hardware.



*Visit us at the International Fastener Expo at the Mandalay Bay Exhibition Hall, Bayside B-C, Las Vegas, Nevada from October 30 through November 1, 2018. **Booth: 2301***

ELECTRONIC HARDWARE CORPORATION

1.800.752.1680 TOLL FREE

PHONE: 631.752.1950

WWW: ehcknobs.com

EMAIL: sales@ehcknobs.com

MID-WEST FASTENER ASSOCIATION TABLE TOP SHOW ELK GROVE VILLAGE, IL - JUNE 4, 2018







**COMPONENT
PACKAGING**

Whatever It Takes.

- KITTING
- HAND PACKAGING
- ASSEMBLY

- ★ New Look Corporate Logo
- ★ New & Improved Website
- ★ New Equipment incoming, boosting capacity by 30%
- ★ Same Great Quality & Service

TELEPHONE:
417-624-9395

FOR MORE INFORMATION
CONTACT LORI OR NICK:
lorim@componentpackaging.com
nickm@componentpackaging.com

VISIT OUR NEW WEBSITE AT:
www.componentpackaging.com



Our customers make us who we are and that's what drives us to perfection - we are passionate about packaging...it's what we do!



INTERNATIONAL FASTENERS, INC.

Trick or Treat this Halloween at our IFE booth #2841 in Las Vegas!

"The Distributor's Choice"

Quality Construction Fasteners



Make us your choice today!

TEL (888) 241-0203 FAX (888) 241-2096 EMAIL sales@daggerz.com WEB www.daggerz.com

tampa . charlotte . chicago . dallas . los angeles . philadelphia



The 2018 Edition IFI Book of Fastener Standards

The 2018 Edition IFI Book of Fastener Standards is an essential “one-stop” compilation the most commonly used fastener standards for inch fasteners and non-ISO metric fasteners. The book contains 92 separate standard specifications issued by ASTM, ASME, SAE and IFI. More than 40 standards included in the 2018 edition have been updated (or added) since publication of the previous 9th Edition (2014).

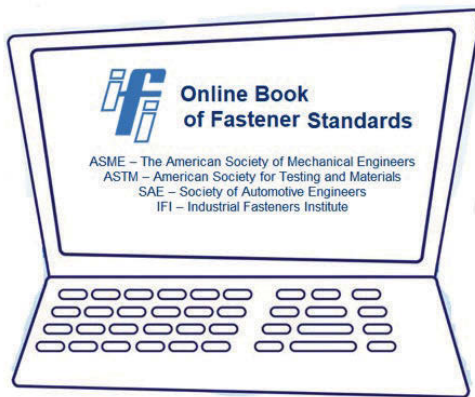
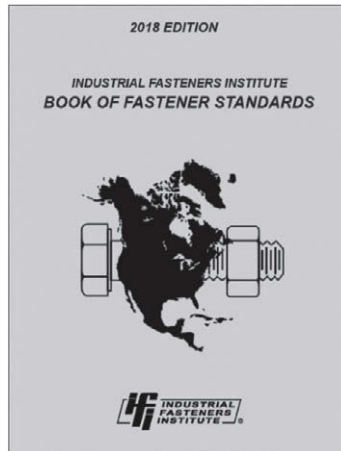

The IFI Online Book of Fastener Standards

The IFI Online Book of Fastener Standards is a digital library that provides access to 92 of the most commonly used fastener standards for inch fasteners and non-ISO metric fasteners issued by ASTM, ASME, SAE and IFI. These are the same standards available in the hardcover 2018 Edition IFI Book of Fastener Standards. The online platform is a convenient an essential “one-stop” collection that is always current, making it the perfect source of the latest standards for an auditable quality management system.

ISO Metric Threads and Fastener Standards

The ISO digital collection is now available thanks to IFI efforts! The Industrial Fasteners Institute (IFI) has been licensed to sell individual ISO metric thread and fastener standards as well as the ISO Screw Thread

and Fastener Handbook for many years. However, the ISO Screw Thread and Fastener Handbook is no longer available through the IFI or any other licensed reseller, because in 2014, ISO decided to altogether stop printing the hardcover collection. Since then, ISO TC 1 and TC 2 standards have only been available for purchase individually at a cost that quickly becomes forbiddingly high if a user needs more than a handful of standards.

After lengthy discussions and pressure by IFI, we are very pleased to announce that an agreement has been reached with ISO and the Standards Council of Canada (SCC) to make available the ISO Fastener Collection as an online digital subscription. The objective of this effort was to make the full fastener collection available to users in North America at a cost that mirrors the old hardcover ISO Fastener Collection.



Standards Council of Canada
Conseil canadien des normes



The collection includes all the standards under the jurisdiction of ISO technical committees TC 1 (Threads) and TC 2 (Fasteners), for a total of 218 standards. The ISO Fastener Collection is now available via the Standards Council of Canada (SCC) using the ISO Online Browsing Platform (OBP), at a very reasonable cost of \$498 CAD per year for one user. Up to 10 user-seats may be purchased for an annual subscription cost of \$1,122 CAD. Same as with the new IFI Online Book of Standards, one of the key benefits of ISO Online Browsing Platform is that the user always has access to the latest revision of any standard in the ISO Fastener collection. The availability of the ISO Fastener Collection is a significant development that will go a very long way to serving the needs of manufacturers, distributors and users of fasteners in North America who have had no way to access ISO Fastener standards in a cost-effective manner since 2014.

A subscription ISO Fastener Collection on the ISO Online Browsing Platform can now be purchased directly from ISO via Standards Council of Canada (SCC) at <https://scc.isolutions.iso.org/obp/ui#iso:pub:PUB200006:en>.

The IFI technical staff encourages all users of ISO Fastener standards to subscribe to this resource.

NAS FASTENERS NATIONAL AEROSPACE STANDARDS SERIES

CUSTOMER DRIVEN. CONTINUOUS IMPROVEMENT.

• **RAF** offers an extensive line of **NAS fasteners**, made to **NAS specifications**, including: **NAS 1829 Male-Female Standoffs**, **NAS 1831 Female Standoffs**, **NAS 42 Spacers**, **NAS 43 Spacers**, **NAS 61 Spacers** & more!

• **Applications include:** aerospace, military, defense, naval vessels, industrial, medical, electronics systems and weapon systems.

• RAF is DFARS, RoHS, ITAR and REACH compliant

• ISO9001:2015 Certified

RAF Electronic Hardware

95 Silvermine Road P (203) 888-2133
Seymour, CT 06483 F (203) 888-9860

www.rafhdwe.com
info@rafhdwe.com



RAF Electronic Hardware is a location of MW Industries, Inc. ©2018 MW Industries, Inc. All rights reserved.



RAF ELECTRONIC HARDWARE

MW Industries, Inc.

THE DISTRIBUTOR'S



THE NATIONAL MAGAZINE FOR FASTENER DISTRIBUTORS

Subscribe

Subscribe to Link Magazine and don't miss an issue!

Yearly subscription consists of 4 issues published quarterly.

United States US \$50.00
Canada and Mexico US \$60.00
Rest of the World US \$70.00

Checks or money orders accepted
No credit cards
Payable to: **Distributor's Link, Inc.**

Your details

Company _____
Name _____
Address _____
City _____
State/Zip _____
Telephone _____ ext _____
Fax _____
Email _____

Additional information

Business type

Distributor Manufacturer
 Representative Other

Position held

President Vice President
 Sales/Buyer Other

How did you hear about us?

Trade Show Internet Search
 Recommendation Other

THE BEST MULTIMEDIA ADVERTISING SOLUTION FOR THE FASTENER INDUSTRY

advertising tracey@linkmagazine.com editorial leojcoar@linkmagazine.com toll-free 800-356-1639 tel 239-643-2713 online www.linkmagazine.com

THE NATIONAL MAGAZINE FOR FASTENER DISTRIBUTORS



FOLLOW US



[3] Service Temperature & Thermal Conductivity

- Solid ceramic fasteners routinely withstand environmental temperatures from 800 to 1650°C (1472 to 3000°F). Solid ceramic fasteners also do not conduct (transfer) heat, possessing very low thermal conductivity. Connecting applications or materials with dissimilar temperature requirements is an example in which low thermal conductivity would be a requirement.

[4] Coefficient of Thermal Expansion - This is the measurement of the fastener's change in size as its environmental temperature is increased. Solid ceramic fasteners possess a low to very low coefficient of thermal expansion. Connections and applications that must remain dust-free, gas tight, or leak free (such as a laser chamber) during changes in temperature are examples in which solid ceramic fasteners are often used.

Other Characteristics

Solid ceramic fasteners are non-magnetic (like a polymer) yet possess a high mechanical strength (like an alloy). They are non-porous and non-outgassing. Ceramco fasteners are made under ISO 9001:2015 certified guidelines in our ITAR registered New Hampshire facility.

Mechanical Properties (Strength)

Strength is accomplished in two ways:

[1] Fully molding the solid ceramic fastener, including the threads to avoid machining, as it is the machining that weakens the ceramic.

[2] Full density firing of the solid ceramic fastener; the ceramic composition determines the length of time it can fired.

Ceramco's alumina and zirconia fastener compositions are fully molded and fired to full density. Solid ceramic fasteners (like all fasteners) have limits to their strength ratings. These characteristics are called: "Mechanical Properties." When not over-torqued, or subjected to impacts, Ceramco's solid ceramic fasteners deliver consistent, reliable and long-lasting performance.



White Paper Available

In October 2017 Ceramco released a comprehensive study of the mechanical properties of their solid ceramic fasteners. The unbiased testing was conducted by a third-party laboratory. Its content is far too in-depth for inclusion in this editorial.

A copy in PDF form may be downloaded from our website at: www.ceramcoceramics.com/report.

Class Dismissed:

You now have a basic understanding of the numerous roles Ceramco's solid ceramic fasteners fulfill. Solid ceramic fasteners are a low volume, high profit item that solves customer problems that other fasteners can't solve.

We know you have questions. Ceramco's engineers and customer support are ready to answer them. Please contact us for immediate, personal assistance. In addition to discounted pricing, stocking distributors are eligible for bonus commissions when annual sales goals are met. Drop-ship arrangements with discounted pricing is also available. 

IDEAL FASTENERS INC.



ISO 9001 and AS9100 Certified



Licensed Manufacturer of
Torx® Drive • Torx Plus® • Torq Set®

Manufacturer of Socket Head Cap Screws

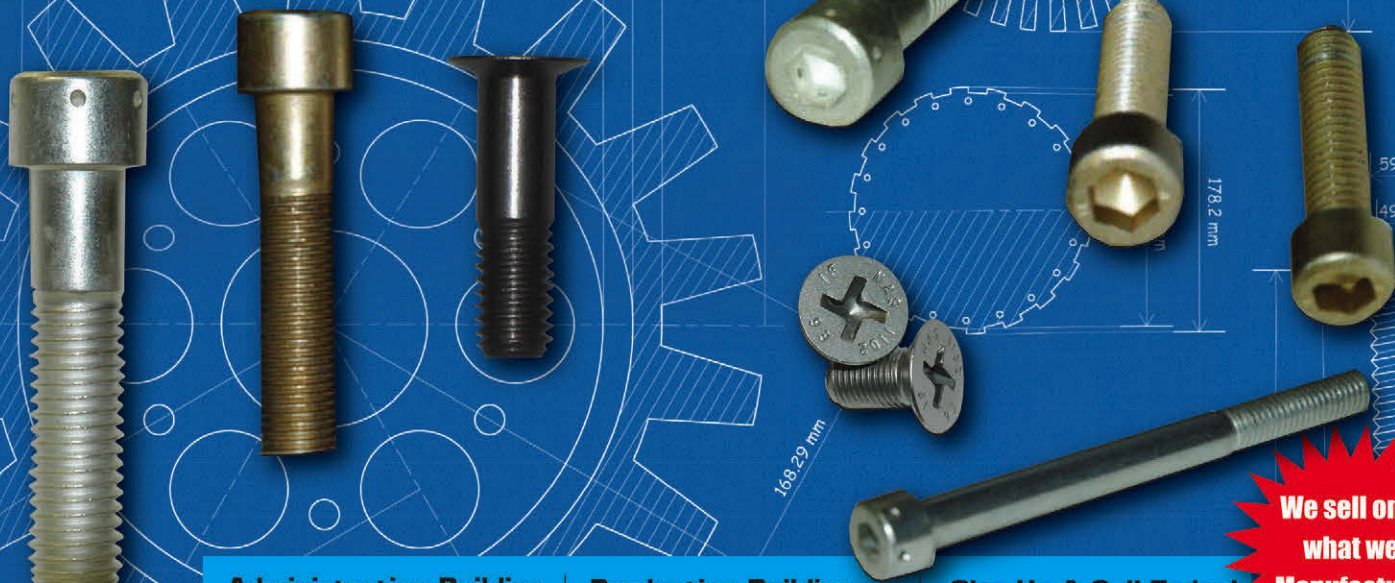

**We sell only
what we
Manufacture!**

Administration Building

3850 East Miraloma Avenue
Anaheim, CA 92806 USA

Production Building

3860 East Miraloma Avenue
Anaheim, CA 92806 USA

Give Us A Call Today!

toll free: 800.821.8540
tel: 714.630.7840
fax: 714.632.3829



www.idealfasteners.com



Representative for New York & New Jersey:

Smith Associates Inc. tel: 973.810.2900 • fax: 973.810.2901 • email: smithfast@aol.com

shear-Loc® THE ORIGINAL INSTANT THUMBSCREW

WWW.SHEAR-LOC.COM



FREE SAMPLES

4 STYLES
INCH

CALL OVER
3000
COMBINATIONS

800-775-5668 FAX 949-768-8705

METRIC

AVAILABLE: IN COLORS, KITS AND A
MULTITUDE OF THREAD OPTIONS

23191 PERALTA DR., LAGUNA HILLS, CA. 92653

distributor news

HellermannTyton's extreme-duty Ratchet P-Clamp has successfully passed validation tests at Underwriter's Laboratory and now carries the UL Listed designation. The unique adjustable wire, cable and hose clamp offers end users a one-of-a-kind solution to route and fasten in a broad range of applications.



"This is important news for product designers, installers and maintenance crews," said HellermannTyton Product Category Manager Missy DeBord. "It will reduce instances of part replacements, and in solar applications, UL Listed components streamline the inspection process."

HellermannTyton offers the fastener with a standard zinc-plated steel base and an upgraded version with a stainless-steel base plate. Stainless steel resists corrosion due to dissimilar metals coming into contact with one another.

All versions of the Ratchet P-Clamp withstand extreme weather and harsh chemicals. Their one piece hinge allows the clamp to open without prying. This means it can be mounted to the work surface before or after the wire, cable or hose bundle has been inserted.

The clamp closes with an interlocking ratchet style mechanism to custom fit the bundle. Four product sizes accommodate any bundle from 1/4 inch to 2 inches in diameter. If removal of the bundle is ever required, the Ratchet P-Clamp can be opened by inserting a small, flat-blade screwdriver without disassembling the clamp from the work surface.

For more information visit the product website at www.hellermanntyton.us/products/featured-products/ratchet-p-clamp.

Manufacturer of the World's Most Secure Fasteners

NEW!

Patented
STICKFIT⁷

Fast, High-Torque, Stick-Fit

A TRUE STICK-FIT!

- Secure! Tamper-proof
- Holds tight
- Will bear weight
- Fast indexing
- Extreme torque
- Non-magnetic
- Available in:

Concrete

Self-drilling

410 hardened stainless

Coated



BRYCE
Fastener

100% American made.

BryceFastener.com

ANNOUNCING

A NEW WINNING COMBINATION



IS NOW AN AUTHORIZED
COATING PARTNER FOR

precote[®] USA

precote[®] products offer optimal solutions for locking and sealing as well as controlled assembly and disassembly. These specially developed products designed for the pre-coating of threads are based on unique microencapsulation technology enabling us to offer many advantages over conventional adhesives. The pre-coated adhesive is inactive until the coated fastener is used. During assembly the adhesive is activated. Able to cure quickly at room temperature, precote[®] coating provides a reliable locking and sealing function.

**FOR MORE INFORMATION
GIVE US A CALL:**

1.800.201.7381

**PLEASE VIEW OUR
NEW WEBSITE**

BRADLEYGOC.COM

LIKE US ON 

PRECOTE[®] 80



PRECOTE[®] 30



PRECOTE[®] 85



U.S. Steelmakers Have Strong Influence

Both Nucor Corp. and United States Steel have objected to 1,600 exemption requests filed with the Commerce Department, the New York Times reports.

"To date, their efforts have never failed, resulting in denials for companies that are based in the United States but rely on imported pipes, screws, wire and other foreign steel products for their supply chains," writes NYT reporter Jim Tankersley.

U.S. companies have filed more than 20,000 requests for steel tariff exemptions, with 639 being denied by the the Commerce Department to date. The majority of those waiver requests await a decision.

Half of those denials came in cases where U.S. Steel, Nucor or AK Steel Holding Corp. filed an objection, a NYT analysis shows. Nearly all of the rest were in cases where the company applying for an exclusion erred in its submission.

Department officials told NYT that they have not granted a single steel exclusion request that drew an objection.

U.S. Fastener Manufacturers Respond

Sara Mallo of Rotor Clip was blunt in her assessment of the 232 tariff waiver process.

"This is a nightmare and a work in process right now," Mallo told FIN. "We will have to pass on to customers if this continues in order to remain a viable source. Steel is our #1 cost driver, so this tariff has had an initial impact on our direct costs," Mark Quebbeman of Semblex Corp. told FIN. "Lead times for alloy steel and carbon steel have had minimal effect for now but this will change if expected material allocation starts to consistently occur."

Regarding passing costs increases on to customers, Quebbeman said: "We are working on this now with our customers and are optimistic we can develop solutions with them. Some of these solutions are already in place and some are pending." Quebbeman said Semblex continues to book "significant" new business. "However, it is still early; the tariff has essentially been in place for only 60 days."

ISSCO, INC/BTM Manufacturing president Jake Davis told FIN he's receiving price increase notifications from prominent suppliers. "This is certainly a very volatile time

within the industry," Davis told FIN. "I have had some tough conversations with a couple of our larger customers, as they are trying to figure our price points for their products as 2019 seems to be right around the corner. "At the moment, the only thing the tariffs have affected is our costs. Lead times remain stable." Davis said most customers are not surprised to see price increases.

US Hikes Section 301 Tariff On Chinese Goods To 25%

The Office of the U.S. Trade Representative announced that the Section 301 duty to be imposed on \$200 billion worth of Chinese goods, including fasteners, will be 25% instead of 10% announced on July 10. The hike in the tariff rate was prompted by President Donald Trump, who directed U.S. Trade Representative Robert Lighthizer to increase it.

"The increase in the possible rate of the additional duty is intended to provide the Administration with additional options to encourage China to change its harmful policies and behavior and adopt policies that will lead to fairer markets and prosperity for all of our citizens," Lighthizer stated.

If implemented, the 25% duty on imports from China would be the third round of Section 301 tariffs on Chinese goods imposed by the Trump administration. Trump has said the tariffs are in response to China's unfair trade practices.

China announced it would hit about \$60 billion worth of U.S. exports with new tariffs in response. "China is fully prepared and will have to retaliate to defend the nation's dignity and the interests of the people, defend free trade and the multilateral system, and defend the common interests of all countries," the Chinese Ministry of Commerce stated. "The carrot and stick tactic won't work."

The U.S. trade deficit hit \$291 billion in the first half of 2018 despite President Trump's efforts to reduce it, and is on track to be the highest in a decade.

Fasteners are listed among the 6,031 tariff codes that would be taxed if the 25% duties are implemented by the U.S. The tariff appears to apply to nearly all fasteners imported from China.

For questions on customs classification of products, contact Traderemedymail@cbp.dhs.gov. 

INTERNATIONAL
FASTENER EXPO
BOOTH #2947

Swageform®

HIGH PERFORMANCE THREAD ROLLING SCREWS

Unique Swageform® design with 3 sets of forming lobes on the tapered lead threads at 120° apart - significantly reducing installation drive torque.

- » Quick and easy installation
- » Elimination of tapping of holes
- » Low drive torques
- » High strip out torques
- » Formed (not cut) threads
- » Elimination of chips



Innovative solution with over 40 years of proven applied applications



ISO 9001-2015
IATF 16949-2016



Swageform® is a Registered Trademark of



think outside the



TEL 800-888-7367 • FAX 815-874-0100 • WEB www.semsandspecials.com



MM DISTRIBUTION LLC

FASTENER DISTRIBUTION SPECIALIST

We are a master importer of standard and specialty fasteners, offering a range of value added services and unrivaled customer service

FLOOR BOARD SCREWS • SOLID & BLIND RIVETS • RAIL BOLTS • DRIVE ANCHORS • LINER SCREWS • DRILL & SCREW BITS
PACKAGING • IMPORTING • ENGINEERING • CUSTOM PARTS • MODIFIED PARTS



MM DISTRIBUTION LLC 218 W. Court Street, Suite C, Washington CH, OH 43160
Tel: 740-335-9136 | Fax: 614-467-3670 | Email: alex@mmfastenersdist.com

www.mmfastenersdist.com

ROBERT FOOTLIK PREPLANNING CAN SAVE YOUR BUSINESS AND YOUR LIFE *from page 56*

Similarly, purchasing 20' x 40' tarps today is cheap and easy. Finding these after a widespread disaster might be impossible. Thousands of dollars and weeks can be saved by having emergency supplies on hand. One tarp spread over the tops of some pallet racks can provide instant shelter for both stock and personnel.

Training And Planning Are The Key To Survival

Exit route plans are useless if no one follows them. The difference between escape and death lies in the training and conditioning that the personnel receive. Sending someone to use a fire extinguisher at a critical moment only works if the individual knows how to use this equipment effectively...while others are notifying the emergency authorities.

Numerous training brochures and aids are available from the Red Cross, local fire departments, your insurance carrier, the National Safety Council and a multitude of online resources. Typically these also offer guidelines for developing a comprehensive program for coping with disaster. Use these as a starting point for creating a plan in your context.

Keep in mind that the effects of even the worst occurrence can be mitigated by having trained personnel following a well thought out "script" using flexible procedures. For a Fastener Distributor serving the construction trades the larger the disaster, the more important it is to get back in operation to support rescue efforts. In this case, you and your company are vital to everyone.

Contact Information

At the very least, develop an internal communications directory that includes not only the emergency information, but also provides subscriber/policy numbers and identification information. Everyone knows how to call 911, but what about insurance carriers, doctors, sprinkler contractors, electricians, utilities, etc.? Distribute this document to key personnel and maintain a copy at your home. Update this regularly and keep both electronic and printed copies in safe, easily accessible locations.

Similarly, customer and vendor contact information should also be kept in both paper and data file formats. In the event of an emergency, when the power is off, communications shut down and time at a premium having this directory available can save precious hours during a recovery effort. Coping this on a flash drive regularly should be mandatory.

Moving Ahead

The following list is a good starting point for initiating the discussions that can lead to a more comprehensive plan. Every company and region has different needs and resources, but with by planning ahead, training everyone, acquiring emergency supplies before a disaster and adding simple tools now lives can be saved and recovery can be accomplished far safer and faster.

Do this now, before disaster strikes.

Topics and Thoughts for Disaster Planning

Sounding an Alarm

- ▣ Phone the fire and police departments.
- ▣ Notify the appropriate company officers.
- ▣ Evacuate personnel in an orderly manner.
- ▣ Meet at a preestablished safe area for a head count.
- ▣ Direct emergency responders to the problem area.
- ▣ Provide firefighters and others with special condition and hazard information.
- ▣ Restore security and fire protection systems after crisis passes.

Dealing with a fire right now

- ▣ Rescue anyone in danger.
- ▣ If trained personnel are available, start putting out the fire.
- ▣ Turn off power, gas and other utilities, but NOT SPRINKLERS and PUMPS.
- ▣ Keep spectators and untrained personnel away from the crisis.
- ▣ Verify the operation of sprinklers and/or other emergency equipment.
- ▣ Coordinate all actions of the internal emergency team and external personnel.
- ▣ Evacuate all personnel, including the company emergency team if necessary.

Fire or an emergency nearby

- ▣ Evacuate to a safe place.
- ▣ Stay out of the way of emergency personnel and vehicles.
- ▣ Clear the path for emergency vehicles (move parked cars, open gates, etc.).
- ▣ Determine if any special hazards are involved and take appropriate steps.
- ▣ Eliminate ignition sources downwind of any nearby burning facilities.

distributornews

Women In The Fastener Industry (WIFI) has announced its annual scholarship and 2nd Annual Awards winner.

Mary Chambers - has been awarded the 2018 Women of the Year. "I feel very fortunate to be in this business. It has given me much to be happy and proud of. I like to think that in some small way my great adventure has helped women in our industry. I applaud all of the women that work in our industry and hope that they are indeed happy and will continue support women as more of us take advantage of the many opportunities that this industry affords us." ~ Mary Chambers Mary has been in the industry since 1972 and she will be retiring next month.

Suzanne Dukes from Hayes Bolt will be receiving the 2018 Women in Business for helping women in her business and community.

John Butler from Olander Company will be receiving the Man up for WIFI 2018 award for supporting women in the fastener industry.

Nikki Sedwick from Brighton-Best International has won the Edith Cameron Scholarship. Nikki will be attending this year International Fastener Expo (IFE) in October in Las Vegas, NV. You will be able to meet Nikke at booth #3757.

Melody Keown from All American Threaded Products has won the Ann Bisgyer Wolz Scholarship she will be attending the Fastener Training Institute fastener week to become a Certified Fastener Specialist.

For more information about WIFI and memberships visit us at www.fastenerwomen.com.

INTERNATIONAL FASTENER EXPO
BOOTH #2916



Your 'one-stop' supplier for grease fittings & accessories





GREASE FITTING THREAD IDENTIFIER

NOW AVAILABLE WITH CUSTOM LOGOS & COLORS

The Perfect Solution



- COUPLERS & HOSE WHIPS
- GREASE FITTING CAPS
- GREASE GUNS
- CUSTOM DESIGNED FITTINGS
- FITTING ASSORTMENTS
- PRIVATE LABELING
- CUSTOM KITTING

STOCKING LOCATIONS IN MUSKEGO, WI & ARLINGTON, TX

TEL 1-800-360-1318 FAX 1-262-789-8640

EMAIL sales@gfdsystems.com WEB www.gfdsystems.com

W160S6381 COMMERCE DRIVE, MUSKEGO WI 53150

NEW ENGLAND FASTENER DISTRIBUTORS ASSOCIATION

PO Box 151, Lake Zurich, IL 60047

TEL 847-370-9022 FAX 847-516-6728 EMAIL nancy@nefda.com WEB www.nefda.com

NEFDA GOLF OUTING A GREAT SUCCESS

by Nancy Rich

This year's NEFDA Golf Outing, held at Oak Ridge Golf Club (in Feeding Hills, MA) was once again a great scholarship fund raiser event. Almost 80 golfers met for what turned out to be a great June day in New England. Lunch, golf, dinner, awards and raffles filled a fun day.

Congratulations To Our Winners

First Place Team

Wayne Wishnew - XL Screw Corporation
Skip Maxfield - Nefco
Harrison Maxfield - Nefco
Alex Maxfield - Nefco

Second Place Team

Jason Webster - North East Fastener
Thomas Burdette - North East Fastener
Rich Kowalczyk - North East Fastener
Carrie Ingham - Specialty Bolt & Nut

Longest Drive

Men Skip Maxfield - Nefco
Women Carrie Ingham - Specialty Bolt & Nut

Closest to the Line

Men Bill Warmer - SB&W
Women Carrie Ingham - Specialty Bolt & Nut

Closest to the Pin

Men Dennis Clark - Beacon Fasteners & Components
Mike Hetwosz - RAF Electronic Hardware
Women Gretchen Grove - Pilgrim Screw

Thank you to the many companies who donated raffle prizes.

A big thank you to Larry Ward - *Distribution One* and Joel Koppe - *Metric & Multistandard Components* for putting the outing together.

It was an awesome event and we invite everyone to mark their calendars for June 13, 2019 for the next NEFDA Golf Outing.

NEFDA Awards Scholarships

The NEFDA is proud to announce their 2018 scholarship recipients.

\$4,000	Meredith Roach	<i>EFC International</i>
\$3,000	Kendyll Smith	<i>Spirol International</i>
\$2,000	Caitlin Rundle	<i>R.W. Rundle Associates</i>
\$1,500	Connor Wiklund	<i>D&B Roberts</i>
\$1,500	Hannah Morrison	<i>Buckeye Fasteners</i>
\$1,000	Kayla Radel	<i>Solution Industries</i>
\$1,000	Kelly Penland	<i>Eurolink</i>
\$500	Hannah Tedder	<i>EFC International</i>
\$500	Emily Gray	<i>W.J. Roberts</i>

Upcoming Events

December 5th Holiday Party
High Rollers Bowling Alley
Foxwoods Resort
Mashantucket, CT

NEFDA New Member

Bolt Depot - Hingham, MA 

NEFDA GOLF OUTING - OAK RIDGE GOLF CLUB FEEDING HILLS, MA - JUNE 7, 2018



STAFDA STAFDA'S PHOENIX CONVENTION & TRADE SHOW RISING TO THE OCCASION *from page 62*

Monday morning's business program, the General Session, features two State of the Industry speakers: STAFDA President, Michelle St. John, Industrial Bolt & Supply, Auburn, WA and Associate speaker, Bill Sisto, G-STRUT, Canton, OH. Keynote speaker, business author and expert, Jon Gordon, will close the program with his insights on how to build a successful company culture, align personal goals with company goals, and how to connect and communicate with colleagues.

STAFDA's Trade Show is open for six hours on Monday and another 5.5 hours on Tuesday, October 30. There are over 35 different product categories in

STAFDA so the array of products on display ranges from abrasives to hand tools, safety equipment to power tools, generators to aerosols, and everything in between! It's a buying show and distributors are there to expand their line card! Also in the Trade Show are two Pavilions: one features business technology and the other showcases STAFDA consultants and endorsed service providers. Specialists in both Pavilions can meet individually with members to help them assess their company's needs, or give them the chance to demo the latest in hardware and software technology.

Spouses/Companions haven't been left out! They have a special workshop Sunday afternoon to build rocking horses for Phoenix Children's Hospital and on Tuesday, October 30, they've got two tour options: a day trip to Tucson or a Phoenix/Scottsdale city tour along with shopping. But whether attendees are in the Trade Show or returning from a tour, the meeting ends with a Closing Party Tuesday night to wrap-up the three day meeting.

The STAFDA Convention & Trade Show is for members-only. For membership information or Phoenix details, please visit www.stafda.org.

SPECIALTY TOOLS & FASTENERS DISTRIBUTORS ASSOCIATION

SOUTHEASTERN FASTENER ASSOCIATION

PO Box 448, Elba, AL 36323 TEL 847-370-9022 FAX 847-516-6728 EMAIL sefa@thesefa.com WEB www.thesefa.com

SEFA IS HEADING FOR THE BEACH IN 2019!!

by Nancy Rich

SEFA ANNOUNCES 2019 SPRING CONFERENCE VENUE...

The Southeastern Fastener Association will be holding its 2019 Spring Conference at the Sandestin Golf and Beach Resort in Miramar Beach, FL. The event will feature informative sessions, supplier exhibits, golf and social events.

The dates for this event are April 29th to May 1st 2019.

This annual event draws many SEFA members as it is a once a year opportunity to network with fellow members and receive current industry information. The 2019 location will be a great spot for attendees to extend their visit and spend a few extra days to relax and explore the area.



SEFA Welcomes New Members

Ace Bolt & Screw Co., Inc. - Buford, GA

Duraswiss LLC - Matthews, NC

Threaded Fasteners Inc - Mobile, AL

Narragansett Screw Co.

Domestic Manufacturer of Quality Cold Headed Fasteners - Made to Industry and IFI Standards



- ❑ **NO MINIMUM ORDER** - No job is too small!
- ❑ #2 thru 3/8" Diameter up to 4" Length
- ❑ Many in-house Secondary Operations including Drilling, Shank Slotting & Trimming
- ❑ **Screw types include:** Machine Screws, Captive Screws, Shoulder Screws, Square Neck and Rib Neck Carriage Bolts, Weld Screws, Flat Socket Cap and Button Socket Cap Screws plus all your standards from Type 'A' and 'AB' to 'U' Drives and Type "TT"
- ❑ We manufacture parts from prints or samples
- ❑ We specialize in stainless steel but also run parts in steel, brass, bronze, copper, monel and aluminum
- ❑ **Expanded capabilities include:** Button Socket Cap and Flat Socket Cap Screws, 6-Lobe Tamperproof, Escutcheon Pins and Metric Fasteners



Narragansett Screw Co.

119 Rowley Street, Winsted, CT 06098
Tel: 860-379-4059 | Fax: 860-738-9234
www.narragansettscrew.com

NARRAGANSETT SCREW CO.

119 Rowley Street, Winsted, CT 06098
TEL 860-379-4059 FAX 860-738-9234
EMAIL sales@narragansettscrew.com
WEB www.narragansettscrew.com

NARRAGANSETT SCREW COMPANY RECEIVES ISO 9001:2015 CERTIFICATION

Narragansett Screw Company was recently issued its ISO 9001:2015 Certification as a manufacturer of Rivets & Threaded Fasteners including Specials in Steel, Alloy, Stainless Steel, Monel, Brass, Bronze and Aluminum. Narragansett Screw is owned and operated by Charlie Rhoades, a veteran of cold heading. Charlie grew up around the fastener industry, learning much from his father who was also a fastener veteran. "My father worked for Pheoll Manufacturing and I have been around cold heading my entire life" said Charlie. After his years with Pheoll, Charlie's father ran a small family-run cold heading operation where Charlie worked for over 20 years. Today, several of Charlie's family members are involved at Narragansett.

Currently, Narragansett is housed on a 35,000 square foot facility. "We have a lot of equipment here" said Jessica Rhoades, Charlie's daughter and customer service manager. "We make a lot of standards but also a lot of specials and made to print parts. We have a lot of secondary capabilities like drilling, shank slotting, trimming and it is all done onsite in our facility."

The Rhoades family is proud that they still supply the market with a quality, domestically produced product. "It does get tough with all the import product out there", said Charlie, "but we feel there is still a market for competitively priced, cold headed products manufactured in the U.S."

Narragansett has remained a strong company by trying to accommodate the needs of its customers and that includes running small orders. "We will run a few thousand pieces of a part if a customer only needs that", said Charlie, "but we can also run a few million pieces and we can be very competitive." 

ANTHONY Di MAIO BLIND RIVET SPECIFICATIONS from page 70

This 2.5 lbs. retention requirement is necessary to ensure the User that the blind rivet will stay assembled during shipment to his location.

The mandrel retention between the rivet body and mandrel before setting is much higher for those blind rivets that are used in conjunction with the Automatic Blind Rivet feed system that are in today's market. In these automatic feed and setting systems, the blind rivet is fed from a vibrating feeder bowl into a compressed air chamber and the compressed air transports the blind rivet at a high speed to the blind rivet setting tool. The blind rivet comes to a rapid stop when it reaches the blind rivet setting tool. If the retention between the rivet body and mandrel is not sufficient, the mandrel will disassemble from the rivet body when the blind rivet comes to a rapid stop.

The IFI-114 specification states that the mandrel point is "POINT STYLE OPTIONAL". Basically there are 3 types of mandrel points that are used by blind rivet manufacturers.



DIAMOND POINT



PENCIL POINT

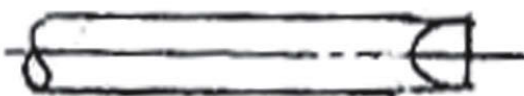

SQUARE POINT

FIGURE 2

Blind rivet manufacturers try to produce mandrels with a dull point because of safety reasons. Sharp points are dangerous when the operator reaches into a bulk carton of blind rivets. It would be a good practice for blind rivet users to request from their blind rivet manufacturer that they want dull mandrel points for safety reasons.

There are also 2 types of mandrel heads that are produced for Open-End blind rivets.

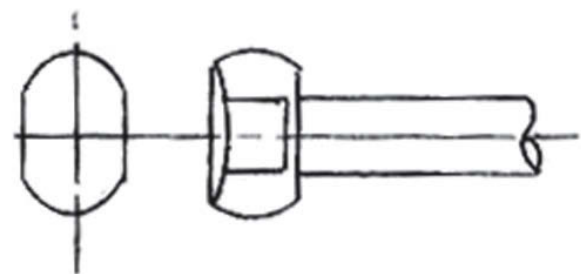

OVAL HEAD

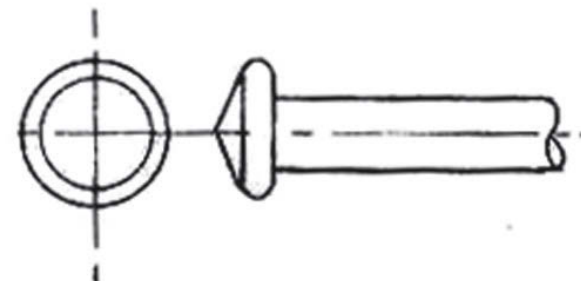

ROUND HEAD

FIGURE 3

Oval Heads are used mostly with blind rivets that have a stainless steel rivet body for greater head retention after setting the blind rivet. The Oval Head is mostly used on steel and stainless steel mandrels that are assembled with stainless steel rivet bodies.

Round Heads is the most popular head configuration and are used for all other alloys and sizes of Open-End blind rivets. 

LARGE & SPECIAL FASTENERS FAST!

- HUGE INVENTORY
- OFF THE SHELF AND QUICK
- JUST-IN-TIME DELIVERIES
- SAE OR ASTM SPECS
- STRATEGICALLY LOCATED
WAREHOUSES NATIONWIDE
- YOUR REQUIREMENTS IN-STOCK
SPECIALS OR STANDARDS
- DEPENDABLE AND TRACEABLE



CORPORATE OFFICE/MAIN WAREHOUSE

Box 2035, 2941 E. 10 Mile Road, Warren, Michigan 48090-2035
586-757-4100 / 800-882-0747 • 586-757-1555 fax • sales@darlingbolt.com

HOUSTON WAREHOUSE

1915 Turning Basin Drive, Suite #506, Houston, Texas 77029
713-673-3971 • 713-672-6642 fax

LOS ANGELES WAREHOUSE

11023 Forest Place, Santa Fe Springs, California 90670
562-946-1458 • 562-946-3268 fax

**DARLING BOLT
COMPANY**

Since 1958

(800) 882-0747
www.darlingbolt.com

fastenerlinks

THE DEFINITIVE WEB DIRECTORY FOR THE INDUSTRY



www.3Q-inc.com



ABBOTT-INTERFAST ISO 9001
QUALITY & INTEGRITY
888-490-9424
www.abbott-interfast.com



Accurate
Manufactured
Products
Group



Shoulder Screws • Mating Fasteners
www.ampg.com

Formed spring steel fasteners
www.e-equal-fast.com



Advanced
Poly-Packaging, Inc.

Solutions driven approach for
bagging fasteners.
www.advancedpoly.com

Ajax Wire Specialty Co., Inc.
Think Springs. Think Ajax!

Toll Free: 855-966-AJAX (2529)
Fax: 516-935-2334
www.ajaxwire.com



www.albanysteel.com

from STOCK

'B', 'F', 'U', '21', TEKS®, SWAGEFORM®
Thumbscrews, Wing Nuts, Screwnails



NOW AVAILABLE FREE IN THE APP STORE

READ NEW ISSUES KEYWORD SEARCH
VIEW ARCHIVES NO WIFI NEEDED



Industrial Cutting Tools
and Abrasives



www.alfatools.com • 1-800-253-2532



Quality producers
of Washers and
Stampings

847-566-9091
www.allamericanwasherwerks.com



**ALLOY &
STAINLESS
FASTENERS**

www.GoASF.com



508-520-4005 • Fax 508-520-4185
www.agmi.com



**ALUMINUM
FASTENER**

IT'S WHAT WE DO.
www.aluminumfastener.com



**A3 AMERICAN
BELLEVILLE**

LES RIGA PERRY BLOSSOM
L.Riga@americanbelleville.com P.Blossom@americanbelleville.com

www.AmericanBelleville.com



jay@discountscrews.com

AMERICAN IMPERIAL

800-431-2391
Over 500 million screws in stock



www.atticaautomation.com



aztec
washer
company

when reliability counts

www.aztecwasher.com



Your Guide to Sensible Machinery Solutions.

**Barbarotto
Int'l Machinery**
Oceanside, New York



BarbarottoMachinery.com/New/Bonotto-Packaging
1-888-988-8703
IFE 2018, Las Vegas Booth# 2808

BRINGING YOU THE FASTENER INDUSTRY IN A CLICK!

www.linkmagazine.com

fastenerlinks

BAR STOCK SPECIALTIES, INC.
 Specialty Steel & Metal Processing
 for Your Custom Bar Requirements
www.GoBarStock.com

Bay Supply
www.baysupply.com

Beacon
 FASTENERS AND COMPONENTS, INC.
 HIGH-LOW TAPPING | SHEET METAL | SEMS | THREAD CUTTING | THREAD FORMING
 AND NEW MACHINE SCREWS!
 800-669-2658 | www.beaconfasteners.com

BIG RED FASTENERS
www.bigredfasteners.com

THE BRADLEY GROUP OF COMPANIES
 Pre-applied adhesives & sealants
www.bradleygroupcoatings.com

BRIGHTON-BEST INTERNATIONAL
 Master Distributor / Importer for all your fastener needs
 BEST Quality, Service, Value Since 1925
 800-275-0050
www.brightonBEST.com

BRIKSEN
 STAINLESS STEEL FASTENERS
www.brikksen.com

BRYCE
 Fastener
 100% American made.
BryceFastener.com

BTM
 MANUFACTURER & DISTRIBUTOR OF U-BOLTS,
 CUSTOM BENT WIRE PRODUCTS AND SPECIALTY THREADED FASTENERS
www.btm-mfg.com

Buckley QC Fasteners
www.bqcf.com

follow us on **twitter**
@OfficialLinkMag

Capital Marketing
 Sales and Marketing from a
 Premier Agency
www.capital-marketing.com

Carver Consulting
 Fastener consulting and CAD services
www.carverem.com/drawings
 1920 Cordell Ct. Ste. 101 El Cajon, CA 92020 Tel: 619-440-5888

CAV CAVALIER
 Industrial Specialties
www.GoCAV.com

Century Fasteners Corp.
 HONORED SUPPLIER OF CHERRY
www.centuryfasteners.com

LOW VOLUME • HIGH MARGINS
Ceramco, Inc.
 603-447-2090 • www.ceramcoceramics.com/linkstock.fasteners@ceramcoceramics.com
SOLID CERAMICS

• Steel Forgings • Wire Forms
Chicago Hardware & Fixture Company
www.chicagohardware.com

COMPONENT PACKAGING
 Whatever It Takes!
www.componentpackaging.com

The Business Edge
 Simple • Focused • Effective
www.ci-inc.com
 Computer Insights, Inc.
 The Best Software For Tracking Your Progress

CONTINENTAL AERO
 The Standard of Excellence Since 1948
www.continental-aero.com

Copper State
Critical Care Fasteners
www.copperstate.com

fastenerlinks



craftech
INDUSTRIES, INC.
www.craftechind.com



CRESCENT MANUFACTURING
PROUDLY MADE IN THE USA
www.crescentmanufacturing.com



The Dale Company
www.dalecompany.com



DARLING BOLT CO.
www.darlingbolt.com
E-mail: sales@darlingbolt.com



THE DECC COMPANY
Your Rack-Spray Coating Specialist
www.decc.com

DISTRIBUTION



ERP SOFTWARE INNOVATIONS FOR
WHOLESALE & DISTRIBUTORS
WWW.DISTONE.COM



DUNKLEY INTERNATIONAL, INC.
MANUFACTURERS OF QUALITY MACHINERY SINCE 1885
www.dunkleyintl.com



DYNACAST
www.dynacast-ip.com



E&T FASTENERS
INDUSTRIAL FASTENERS & COMPONENTS
www.fastenercomponents.com



EHC
www.ehcknobs.com



LINK App
NOW AVAILABLE FREE IN THE APP STORE
READ NEW ISSUES KEYWORD SEARCH
VIEW ARCHIVES NO WIFI NEEDED



EFC INTERNATIONAL
www.efc-intl.com
800.888.3326



Digitalization:
The Future of Distribution
Download eBook
EPICOR



EZLOK
Visit our website today. Complete list
of Thread Inserts/sizes, repair kits.
Request free samples-catalog.
www.ezlok.com



FALL RIVER
Manufacturing Co., Inc.
800-275-6991 / Fax 508-675-8770
WWW.FALLRIVERMFG.COM
Manufacturers of stainless steel
and non-ferrous screws bolts and nuts



FAR
BOLOGNA ITALY
www.far.bo.it



Fascomp
electronic hardware
Standoffs Spacers Jackscrews Shoulder Screws
Thumb Screws Captive Screws Swages
(Tel) 407-226-2112 (Fax) 407-226-3370
www.fascomp.com

For PINS the first choice is:



FASTAR
888-FASTAR5 • Fax 845-369-7989
www.fastar.com



FASTENER FAIR USA
fastenerfair.com/usa
presented by
MACKBROOKS
eBusiness



FASTENER NEWS DESK
@FastenerNews #Fasteners
FASTENERNEWSDESK.COM



FCH 10 YEARS
SOURCING NETWORK FOR THE FASTENER INDUSTRY
www.fastenersclearinghouse.com

BRINGING YOU THE FASTENER INDUSTRY IN A CLICK!

www.linkmagazine.com

fastenerlinks



The #1 source for 410ss screws

www.fordfasteners.com



WWW.GFDSYSTEMS.COM



www.goebel-fasteners.com



www.graphikacreative.com

MARKETING SOLUTIONS FOR THE FASTENER INDUSTRY

DESIGN • PRINT • WEB • EXHIBITIONS • BRANDING • MARKETING



"Quality Service for your Quality Department"



www.growermetal.com



Hanger Bolt

Hangerbolt.com



HANSON RIVET & SUPPLY CO.

866-61-RIVET
(866-617-4838)

www.hansonrivet.com



mw-ind.com

Hi-Performance Fastening System

Hillsdale Terminal & Tool, Inc.

Buy Direct From The Manufacturer

www.hillsdaleterminal.com



follow us on **twitter**

@OfficialLinkMag

ICS Flange

Quality Customer Service
1-800-231-0360

www.innovativecomponentsales.com



www.idealfasteners.com

IDEAL SUPPLY, INC.

Aluminum, Brass, Monel, Silicon Bronze, Stainless, Titanium Fasteners

ILLINOIS Ph. 847.961.5900 Fax. 847.961.8309 Email: idealsupply@idealsupplyonline.net

VIRGINIA Ph. 757.545.8050 Fax. 757.545.8051 Email: va@idealsupplyonline.net

www.idealsupplyonline.net



Industrial Rivet & Fastener Co.

1-800-BUY-RIVET

www.rivet.com



INNOVATIVE COMPONENTS, INC.

for Innovative Solutions

www.knobsource.com



INTERCORP

STRONG-POINT

Get the Point. Strong-Point.

www.strong-point.net

1-800-762-2004



www.interfastgroup.com

INTERNATIONAL FASTENERS, INC.

"The Distributor's Choice"

Quality Construction Fasteners

www.daggerz.com

Make us your choice today!

TEL (888) 241-0203 FAX (888) 241-2096
EMAIL sales@daggerz.com



INTERCONTINENTAL SALES CORPORATION

www.isc-sales.com



If your business is fasteners... your software should be INxSQL.

Effective, Affordable, Efficient

www.inxsql.com • 877.446.9775

fastenerlinks

Johan Smit Fasteners



www.johsmit.com



J.T.D. STAMPING CO., Inc.
www.jtdstamping.com

KEN FORGING

Leader in the Eyebolt Industry

1-888-536-3674 • Fax 440-992-0360
www.kenforging.com

KEY BELLEVILLES, INC.



Tel: 1-800-245-3600
www.keybellevilles.com
email: sales@keybellevilles.com

Kinter is your go-to source for x-mas tree clips — extensive variety and inventory.



Kinter SOLVED
800.323.2369 | kinter.com

LELAND INDUSTRIES INC.

www.lelandindustries.com
1-800-263-3393

FLEXIBILITY VALUE & CHOICE.



BY ANY MEASURE.
www.lindfastgrp.com

NOW OFFERING 133,000 SKUs.

LIPPINCOTT
SUPPLY COMPANY • SINCE 1948

www.lippincottsupply.com

LOCKNUT TECHNOLOGY INC.



WWW.LOCKNUTTECHNOLOGY.COM

Lok-Mor, Inc.

Locknuts
Standards and Specials

www.lok-mor.com
1-800-843-7230

LINKApp

NOW AVAILABLE FREE IN THE APP STORE

READ NEW ISSUES | KEYWORD SEARCH
VIEW ARCHIVES | NO WIFI NEEDED

LUBRICATION COMPONENTS

Your grease fitting source!

www.lubricom.com

MAR-BRO MANUFACTURING
A Fastener Company

P: 602.278.8197 | F: 602.269.1235
MAR-BRO.COM | SALES@MAR-BRO.COM

Mehta Trading International

The Complete Stainless Steel
Fastener Source

www.Mehtati.com
e-mail: Corp@Mehtati.com



Metric & Multistandard Components Corp.

Fasteners • Cutting Tools • Measuring Tools

www.metricmcc.com



MM DISTRIBUTION LLC
FASTENER DISTRIBUTION SPECIALIST

www.mmfastenersdist.com

MW INDUSTRIES, INC.

Manufacturer of custom washers,
fasteners & metal stampings.

www.mwindustries.com

Narragansett Screw Co.

www.narragansettscrew.com



NATIONAL THREADED FASTENERS, LTD.

www.flangescrews.com

phone: 440.350.1430 | fax: 440.350.1676
3705 Lane Rd. Perry, OH 44081
sales@flangescrews.com

ND INDUSTRIES

Advanced Adhesive and Sealant Technologies

www.ndindustries.com • phone: 1-800-471-5000

ISO 9001-2008 AS9100 Certified

NET
NORTH EAST FASTENERS CORPORATION

A Tradition of Precision

WWW.NEFL.COM

Telephone: (860) 589-3242 Fax: (860) 589-6969
8 Tremco Drive, Terryville, CT 06786-0322

BRINGING YOU THE FASTENER INDUSTRY IN A CLICK!

www.linkmagazine.com

fastenerlinks

NOVA
 Complete Stocking Inventory
 Of All Commercial Fasteners
www.novafasteners.com
 e-mail: info@novafasteners.com

 **Offshore Milling
 Services, Inc.**
www.offshoremilling.com

OSSCO
BOLT & SCREW CO.
www.osscobolt.com

 **PINNACLE**
 PINNACLE CAPITAL CORPORATION
www.pinnaclecapitalcorp.com

PIVOTPOINT INC.
 PINS > CABLES > SOLUTIONS
 Award Winning Non-Threaded Fasteners
 Quick Release Pins, Clevis Pins, Cotter Pins
www.pivotpins.com

Prestige Stamping, Inc.
 Phone 586-773-2700
 Fax 586-773-2298
www.prestigestamping.com

PCC
 PRODUCT COMPONENTS CORP.
www.product-components.com

 800-979-1921 • Fax 800-345-9583
www.randrengineering.com

 RAF ELECTRONIC
 HARDWARE
 a Division of MW Industries, Inc.
www.rafhdwe.com
 203-888-2133 • info@rafhdwe.com

W.J. Roberts Company, Inc.
 SPACERS & STANDOFFS
www.wjroberts.com

 follow us on
 twitter
 @OfficialLinkMag

WWW.ROTORCLIP.COM
 Retaining Rings
 Spiral Rings
 Wave Springs
 Hose Clamps

 Designed for Quality

 **MW**
 INDUSTRIES inc.
 Rumco Fastener
mw-ind.com

SCHNORR[®]
 DISC SPRING ENGINEERING
www.schnorr.com

 Tamper-resistant
 screws
www.screwsupply.com
 email: sales@screwsupply.com

 **SEMS and
 SPECIALS**
 Securing the Essentials
www.semsandspecials.com

 **Shanghai Fast-Fix Rivet Corp.**

www.fastfix-rivet.com

THE ORIGINAL
shear-Loc[®]
 **THE ORIGINAL**
 SINCE 1969
 QUALITY
 INSTANT THUMB SCREW
800-775-5668
WWW.SHEAR-LDC.COM
 OR FAX 949-768-8705

www.spacecityscrew.com

SOLUTION INDUSTRIES

 TEL: 866.297.8656
 FAX: 440.816.9501
 EMAIL: sales@solutionind.com
 WEB: solutionind.com
 Your SOLUTION for secondary process
 One call, one price, one shipment, one invoice
 ONE SOLUTION

SPIROL[®]
 Innovative Fastening Solutions.
 Lower Assembly Costs.
WWW.SPIROL.com

BRINGING YOU THE FASTENER INDUSTRY IN A CLICK!

www.linkmagazine.com

fastenerlinks



STELFAST® INC.
 Manufacturer/Importer
www.stelfast.com
 800-729-9779 • Fax 440-879-0044



SUNCOR®
Stainless
www.suncorstainless.com



SUPERIOR
 WASHER & GASKET CORP.
www.superiorwasher.com
 E-mail: swg@superiorwasher.com



SWD
INC.
www.swdinc.com



Tamper-Proof
Screws, Inc.
 California
www.tamperpruf.com
 e-mail: tamperpruf90723@sbcglobal.net
The Ultimate Source in Security Fasteners

Specialists in Studs & Threaded Rods
 See our catalog in the Thomas Register
 and on the Internet at:
www.thomasregister.com
TUTTLE
 MFG. CO. 



UCC
 COMPONENTS
www.uccomponents.com



UMETA
 OF AMERICA INC.
 OEM Quality Grease Fittings
 and Grease Guns
www.umetausa.com



UNICORP
www.unicorpinc.com
 Manufacturer of Precision Electronic Hardware
800 526-1389



UNIQUE
INDUSTRIES, INC.
 Manufacturer of
 Specialty Threaded Items
www.uiind.com • sales@uiind.com



follow us on
twitter
@OfficialLinkMag



USA energy.mw-ind.com
FASTENER
GROUP, INC.
 MW Industries, Inc.



vertex
 DISTRIBUTION
www.vertexdistribution.com



LINK App
 NOW AVAILABLE FREE IN THE APP STORE
 READ NEW ISSUES KEYWORD SEARCH
 VIEW ARCHIVES NO WIFI NEEDED



VAF
VIRGINIA FASTENERS
The Galvanized Source
www.vafasteners.com

VOLT
INDUSTRIAL PLASTICS, INC.
 Finest nylon fasteners in the world.
www.voltplastics.com
www.thomasregister.com/volt
 e-mail: service@voltplastics.com



www.wclco.com
WCL
 "Your Link to Success"



Western Wire Products Co.
www.westernwireprod.com
 E-mail: sales@westernwireprod.com



WILLIE WASHER
 MANUFACTURING CORPORATION
 SPECIAL WASHERS AND STAMPINGS
www.williewasher.com



XL SCREW CORPORATION
www.xlscrew.com
 AMERICA'S FINEST
 QUALITY IMPORTED
 THREADED FASTENERS
 SINCE 1968



www.ZaGO.com
ZAGO
 Sealing Fasteners & Components

BRINGING YOU THE FASTENER INDUSTRY IN A CLICK!

www.linkmagazine.com

distributornews

The Industrial Fasteners Institute (IFI) is pleased to announce the addition of six new members in the last twelve months:

- ▣ *Transvalor Americas Corporation*
- ▣ *Loomis International Ltd*
- ▣ *All Metals Processing of Orange County LLC*
- ▣ *Atotech USA LLC*
- ▣ *Risco Incorporated*
- ▣ *Industrial Rivet & Fastener*

"The North American fastener industry continues to grow despite the challenges manufacturers are facing today," said IFI's new Managing Director Dan Walker. "The addition of these six companies to the institute's ranks is evidence that producers of fasteners, and their suppliers, find tangible value in what the IFI is doing right now. IFI's long history of technical leadership, as well as its commitment to keeping members up-to-date on the happenings in Washington, creates a tremendous amount of value for those that are members."

"We're very excited about the continued growth of IFI and what these new member companies will bring to the table as they get involved in the activities of the institute," said current IFI Chairman Phil Johnson of Agrati. "An organization can only be effective if it has the active support of its membership. IFI's members are very involved, and we're creating things that have real value to manufacturers. That's why we continue to see this kind of growth in our numbers. We're accomplishing amazing things in the areas of technical research, training, government relations and workforce development that no one company could do on its own."

Industrial Fasteners Institute is a trade association of leading North American fastener manufacturers and suppliers of materials, machinery, equipment and/or engineered services. Founded in 1931, IFI members combine their resources to seek solutions that advance fastener application engineering.

IFI welcomes new members, and encourages those who want to learn more about the benefits of institute membership to contact them by tel: 216-241-1482 or visit www.indfast.org.



**SCREW
AND
SUPPLY
INC**



**Not Your
Ordinary
Screw**

**WE STOCK IT SO
YOU CAN LOCK IT!**



TAMPER-RESISTANT SECURITY SCREWS

ALWAYS IN STOCK

IMMEDIATE SHIPMENT

PROUDLY MADE IN THE USA

SCREW & SUPPLY INC
SECURITY FASTENER DIVISION
DON'T SETTLE FOR
ANYTHING LESS!



1712 Church Street, Holbrook, NY 11741
 Toll Free: 800-223-1316 or 631-567-2900 Fax: 631-567-3057
 Email: sales@screwsupply.com Web: www.screwsupply.com

No concessions have to be taken as far as fit/form/function and gaging as there will be no change to the dimension of the part after Kolsterising®. The temperature used in this process is merely used to accelerate the diffusion process, yet is low enough to not initiate any phase changes or risk carbide precipitation causing negative impacts to the corrosion resistance of the base material. Lastly, unlike with common practices mentioned above, there are no foreign materials being applied to the surface of the fastener, so there is no risk of contamination in sensitive environments such as the semiconductor and medical industries, among others. Below we will take a look at recent testing that has been conducted with commercially available F593G hex bolts and comparable hex nuts and its impact on CoF.

The parameters for various test conditions and results can be seen in Table 1. The untreated test conditions S1-S5 allowed us to find the point at which minimal installs could be performed before the surface degradation became so significant that the joint cold welded itself and seized completely. This occurred at 108 ft-lbs (80% of yield strength). It is worth noting that even at 54 ft-lbs (40% of yield strength), which represents the industry-recommended dry installation torque for the ½"-13 stainless steel fasteners, visible thread damage was observed. As reference, carbon steel and alloy steel fasteners recommended installation torque values can be closer to 75-80% of yield strength. For the treated fasteners, S6-S8, we used the 108 ft-lbs as a starting point. As can be seen, we performed 100 installs with a treated bolt and untreated nut and had no signs of galling or thread damage. As the installation torque was continually increased, we ended up in a torque to yield condition (S8), yet there were still no signs of thread degradation. One particular point to highlight is that only the bolt was treated in this test matrix. In instances where the fastener is assembled into a large mating component, these drastic improvements can be achieved by only treating the fastener. Another approach is to treat a nut to be used in conjunction with various lengths of the same diameter and thread pitch bolt.

Fastener Test Results

GALLING TEST RESULTS

Sample ID	Bolt Condition	Torque	% Yield of Bolt	# of Installs	Galling	Description
		(ft-lbs)				
S1	Untreated	54	40	100	Not seized, spins freely	Visible thread damage
S2	Untreated	81	60	100	Not seized, spins freely	Visible thread damage
S3	Untreated	108	80	8	Seized	Visible thread damage
S4	Untreated	94	70	100	Not seized, spins freely	Visible thread damage
S5	Untreated	101	75	100	Not seized, spins freely	Visible thread damage
S6	Treated	108	80	100	Not seized, spins freely	No or minimal damage to threads
S7	Treated	121	90	100	Not seized, spins freely	No or minimal damage to threads
S8	Treated	135	100	100	Not seized, spins freely	No or minimal damage to threads

TABLE 1: THIS TABLE SUMMARIZES THE PARAMETERS AND RESULTS FOR VARIOUS TEST CONDITIONS. THE PROCEDURE WAS TO APPLY TORQUE USING A TORQUE GUN; LOOSEN/BACK-OFF FOUR REVOLUTIONS, REPEAT, AND INSPECT EVERY 25 CYCLES.

A magnified comparison of conditions of S1 and S8 can be seen in Figure 1 and shows the surface degradation that can occur upon subsequent installs. The negative impact that occurs to the thread surface can clearly be seen when installed in a dry condition using industry recommended torque values. Treated fasteners can prevent this from occurring, not only at recommended torque value, but even when torquing to yield conditions.

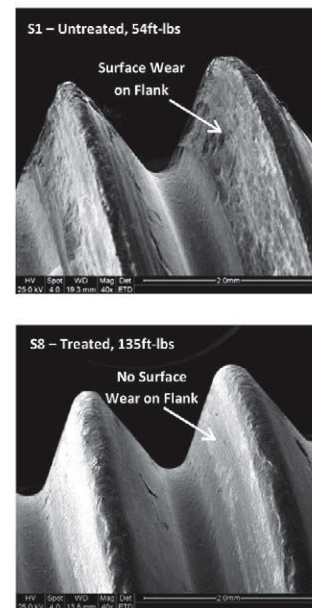

FIGURE 1: THESE SEM IMAGES COMPARE THE INTEGRITY OF THE THREADS BETWEEN UNTREATED AND TREATED TEST CONDITIONS. THE FLANK OF UNTREATED S1 FASTENER DISPLAYS SIGNS OF ADHESIVE WEAR AND POSSIBLE GALLING AFTER REPEATED INSTALLS AT 54FT-LBS. WITH THIS MAGNITUDE OF SURFACE DEGRADATION AT THE FLANK THE FASTENER WILL BEHAVE INCONSISTENT AND NOT BE ABLE TO ACHIEVE THE DESIRED CLAMP LOAD FOR A GIVEN INSTALL TORQUE. WHEREAS THE TREATED FASTENER'S FLANK, WITH REPEATED INSTALLS AT 135FT-LBS, IS SMOOTH AND FREE OF SUCH DEFECTS RESULTING IN A SYSTEM THAT WILL EFFICIENTLY AND CONSISTENTLY TRANSFER TORQUE INTO CLAMP LOAD.



Special Washers & Stampings



- 40,000 Different Special Washers In Stock
- Vast On-Premise Raw Material Inventory
- In-House Tool Room
- Modern CNC and EDM Machines
- Short Production Runs for Prototypes
- Special Sizes and Tolerances
- .062" to 12" O.D.'s in All Shapes and Sizes
- Sheet Materials from .002" to 1/2" Thick

Specials are standard at Willie Washer. You can find over 40,000 different special washers available for same day shipments from Willie's stock. If a special run is what you need, Willie gives you a head start on production with an in-house tool room that has the latest in CNC and EDM machines and a separate short-run division for prototypes and low volume needs. Cap it off with presses that can stamp materials thinner than a sheet of paper, or up to a 1/2" thick, and you'll find the source for your special needs. Look to Willie Washer for quality craftsmanship and flexible production capabilities to make the right size at the right price... right on time!



WILLIE WASHER
MANUFACTURING CORPORATION

SPECIAL WASHERS AND STAMPINGS

MAKING THE BEST WASHERS SINCE 1972

847/956-1344 • FAX: 847/956-7943

HWC AND VERTEX: ALIGNED TOGETHER SERVING DISTRIBUTORS ONLY



The late 19th Century of American history saw the birth of the American Industrial Revolution - and so began the history of Vertex Distribution with the 1881 formation of the Pawtucket Manufacturing Company ("PMC").

PMC began making nuts and bolts for the burgeoning industries that began to dot the landscape of the Northeast. Since this humble beginning in the "horse and buggy" days, PMC eventually grew over the next 135 years to become Vertex Distribution - one of the nation's premier master distributor of corrosion-resistant fasteners.

Many in the fastener industry know Vertex Distribution as "the old Bell Fasteners." However, through a series of growth and acquisitions over the decades (from West-Spec & Zelenda Metric to All Metric Fasteners), Vertex has expanded far beyond its Bell Fastener days.

The Vertex Distribution line now includes a full line of Stainless Steel Inch and Metric Fasteners, Alloy Steel Metric Fasteners, Blind Rivets, Hose Clamps and Security Screws. Vertex has stayed true to its manufacturing roots by making Silicon Bronze and NICU 400 alloy Hex Head Cap Screws at its Attleboro, Massachusetts location.

From its eight stocking locations nationwide, Vertex Distribution provides customers with high quality products, outstanding customer service and superior operational excellence every day with a commitment to quality in every order. From specialized packaging and bar coding to secondary services, mill orders, and stock & release programs, Vertex Distribution delivers a full range of solutions to meet distributor needs.

Expanding product lines to meet the ever-growing needs of distributors, Vertex Distribution has broadened its SKU line with Rivets, Hose Clamps and Security Screws, thus allowing distributors to consolidate vendors and save money in transaction and freight costs.

Recently, Vertex Distribution was acquired by Houston Wire & Cable (HWC). As a leading master distributor in the wire and cable industry, HWC supports continuous improvements at Vertex Distribution through its synergistic alignment of distribution-based selling with an aggressive approach to embracing new technologies across sales, operations, and the ever-changing digital frontier.

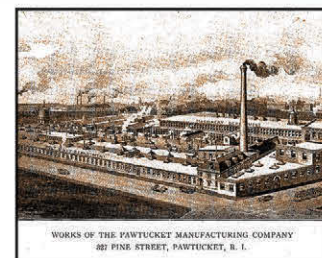

vertex®

DISTRIBUTION

A Division of HWC

www.VertexDistribution.com
Keeping it all together since 1881



RIGHT PRODUCT

Full Line Stainless Steel Inch & Metric
Alloy Steel Metric, Rivets,
Hose Clamps & Security Screws

RIGHT PLACE

Shipping from 8 distribution centers

RIGHT TIME

We deliver when you need it



**VISIT US AT
BOOTH # 3517**



/vertexdistribution



/vertexdist



/vertexdistribution



/vertex-distribution

sales@vertexdistribution.com

Right Product • Right Place • Right Time®

Stainless and alloy steel fasteners

FASTENERS

INCH

METRIC

RIVETS

HOSE CLAMPS

Surface Mount Captive Panel Screw Assemblies

These fastener assemblies in several styles can be installed in boards as thin as .063" / 1.6mm and permit easy removal and reinstallation of boards. They can be provided as a two-piece assembly with a plastic cap or as a spring-loaded, all-metal fastener that is installed preassembled in one piece. The screws can be finger or tool actuated after installation.

Surface Mount Right-Angle Fasteners

These offer an efficient and reliable method to create permanent right-angle attachment points on printed circuit boards as thin as .040" / 1mm. They provide reusable threads parallel to a board to accommodate a component for mounting 90° to the board. They can serve as viable alternatives to conventional angle brackets or threaded right-angle blocks for attaching board to chassis, chassis to board, or component to board.

The shape of right-angle types readily allows the part to be picked up by a pick-and-place machine without requiring a patch. The fastener is presented in the tape and reel with two small pins downward and the flat portion of the fastener's head exposed to the pneumatic finger. The two pins at the bottom act as two very small pilots, providing both stability and locational accuracy during placement.

In addition, a "step" along the bottom allows the solder fillet to be formed along this edge, even while the face of the fastener is flush against an edge of the board. The fastener's rectangular hole reduces the mass and promotes quicker heating to minimize heat draw away from surrounding components on the board.

The rapid rise in attachment applications for compact consumer electronic assemblies has led to extremely small "micro" versions of surface mount fasteners for the jobs.

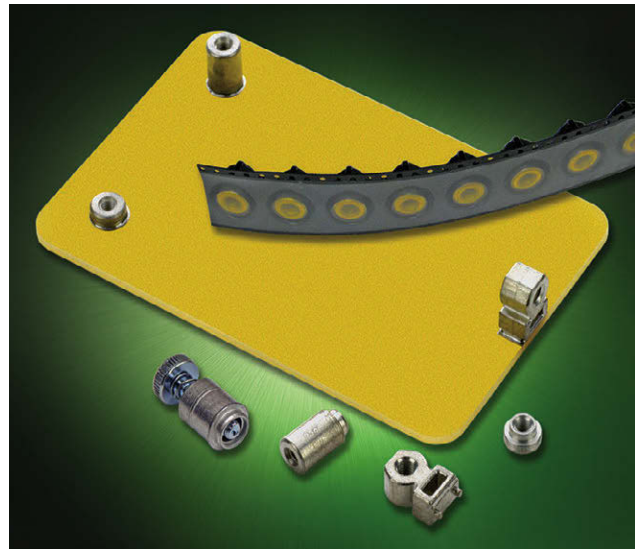

SURFACE MOUNT FASTENERS ARE SUPPLIED ON TAPE AND REEL CONSISTENT WITH SMT AUTOMATED INSTALLATION EQUIPMENT.

Note that micro fasteners are not simply scaled-down versions of their larger counterparts. Special engineering comes into play. As fasteners are "downsized," issues relating to tight tolerances and performance values, among others, become magnified and special features engineered into the fastener often become both critical and essential.

As an example of a special feature, micro versions of spacers, nuts, and standoffs integrate a unique hex-shaped barrel by design to create a larger solder area for enhanced reliability in service. Variations have added even more functionality: Tin-plated brass versions offer superior electrical and mechanical attachment points for a board, in addition to fulfilling requirements for spacing, stacking, mounting, and/or attaching components.

Across the board, surface mount fastening technology can help to streamline production and promote reliable attachment of components.

Michael J. Rossi has more than 30 years of experience in the fastening industry and is Marketing Services Supervisor at PennEngineering®, 5190 Old Easton Road, Danboro, PA 18916-1000 USA. Contact him at mrossi@pemnet.com or 215-766-8853. www.pemnet.com. 



ZAGO MANUFACTURING INC.

21 East Runyon Street, Newark, NJ 07114

TEL 973-643-6700

FAX 973-643-4433

EMAIL info@ZAGO.com

WEB www.ZAGO.com

ZAGO HIGH-TECH SEALING SOLUTIONS & COMPONENTS

For over a quarter century, ZAGO has taken pride in manufacturing high-tech, clean and sustainable sealing solutions and components that exceed fastener distributors' expectations worldwide. And, we're just getting started.

ZAGO's highly-trained team of engineers, client service professionals and manufacturing specialists are up for the challenge, and passionate about crafting high-tech sealant solutions and components that are dependable, reliable and, ultimately, help our clients sleep better at night. ZAGO contaminant-free, green products are returned less than 1% of the time. It's one of the reasons why the world's most innovative and stringent companies, such as Raytheon, Google, GE Energy, SpaceX and the U.S. Army and U.S. Navy choose ZAGO high-tech sealant solutions and components time and time again.

As a provider of a small but critical component, ZAGO's

parts are used in multiple industries such as, aerospace, marine, military, robotics, medical, testing equipment as well as electronic and commercial applications. In today's markets everyone is looking to minimize supply chain delays, economize on cost and maximize efficiency. At ZAGO we are up to the challenge. We have been working diligently to improve all elements of our processes for the past decade. Incorporating the principles of lean manufacturing, we are constantly examining our processes for inefficiencies and waste, focusing on those aspects of manufacturing that provide the most value to the customers. ZAGO's customers recognize the value of working with a company that is lean.

Ready to get on board? ZAGO's team of experts is always available to tackle your engineer's most complex and challenging projects, when competitors say "NO", ZAGO says "YES." 

BUSINESS FOCUS ARTICLE

ZAGO MANUFACTURING INC

Serving a Wide Spectrum of Industries

- Military
- Aerospace
- Electronics
- Food Processing
- Gauges and Meters
- Testing Equipment
- Environmental
- Industrial Equipment
- Instrument Panels
- Marine
- Energy
- Medical Devices
- Robotics



Sealing Fasteners & Components

The Ultimate Seals
on Land, Air & Sea

www.zago.com info@zago.com

+1 973 643 6700

MID-WEST FASTENER ASSOCIATION TABLE TOP SHOW ELK GROVE VILLAGE, IL - JUNE 4, 2018

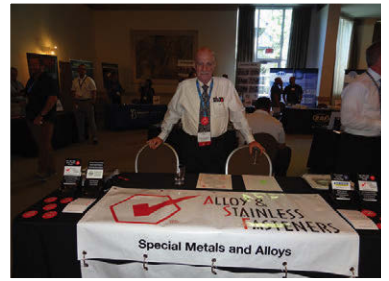

Stamped to Perfection

Every washer, gasket, and stamping we produce meets or exceeds the most stringent specifications. From military specs to your most complex parts, JTD Stamping's Quality, Service and Just-In-Time delivery, are second to none.

Our state-of-the-art tooling and production practices produce the results you expect at costs you can afford. From aluminum to titanium and from in-stock to custom orders, JTD Stamping has provided precision stampings for over 45 years, and with our customers' continued support, we will continue to provide quality stampings for many years to come.

Please do not hesitate to call, write or email us with all your questions and inquiries. We will be happy to quote you on any size order.



J.T.D. STAMPING CO., Inc.

Manufacturers of Washers and Gaskets

ISO 9001:2015 | ITAR Registered
DFARS - RoHS Compliant Product

403 Wyandanch Ave.
North Babylon, NY 11704

Tel: 631-449-7738

Email: quotes@jtdstamping.com
info@jtdstamping.com

www.jtdstamping.com

*J.T.D. Stamping has provided
Precision Stampings for over 45 years*

NEW ERP SOFTWARE BY
SYSPRO COMING 2019



MID-WEST FASTENER ASSOCIATION

PO Box 5, Lake Zurich, IL 60047

TOLL-FREE 1-800-753-8338 TEL 847-438-8338 EMAIL mwfa@ameritech.com WEB www.mwfa.net

GOLF OUTING-FUN NETWORKING FOLLOWING THE MWFA FASTENER SHOW! by Nancy Rich

As in past years, this year's golf outing continued to be a well attended event with 28 golfers teeing off at 7:00 a.m. and another 112 golfers in the afternoon. Almost every hole had a contest allowing many opportunities for golfers to win a prize. Prizes ranged from \$100 to a large flat screen TV.

Congratulations To Our Team Winners

First Place Team

Rich Cavoto - *Metric & Multistandard*
 Jason Bertone - *Fascomp Electronic Hardware*
 Bob Baer - *Abbott-Interfast Corp.*
 Denny Cowhey - *Computer Insights*

Thank you to the team for their prize donation to the Scholarship Fund.

Second Place Team

Tom Bigott - *XL Screw Corporation*
 Weber Huang - *XL Screw Corporation*
 Joe Clark - *Komar Screw*
 Scott Young - *XL Screw Corporation*

Thank You To Our Premium Sponsors

Star Stainless Screw (*Golfers Lunch*)
 XL Screw Corporation (*Cocktail Sponsors*)
 Kanebridge Corp (*Cocktail Sponsors*)
 Nylok (*Cocktail Sponsors*)
 Screws Industries (*Golf Balls*)
 SWD (*Bazooka Sponsor*)

Thank You To Our Skill Contest Sponsors

South Holland Metal Finishing
 Delta Secondary
 Riverdale Heat Treat and Plating LLC
 Big Bolt
 Holbrook
 Central Wire
 Solution Industries
 J&M Plating
 All American Systems

Beacon Fasteners & Components
 Abbott Interfast Corp
 Brighton-Best Int'l
 Fastron Co.
 Kanebridge Corp.
 SWD Inc.
 Morgan Ohare
 Darling Bolt

Thank You To Our Tee/Green Sponsors

Sems and Specials
 INxSQL Software
 Wing-Hamlin Co. Inc.
 SGS MSI
 CSM Fasteners
 FCH Sourcing Network
 EFC Int'l
 Nucor Fasteners
 Distributors Link Magazine
 Continental Aero
 BTM Mfg.
 Fall River Mfg.
 NEF
 Rick Rudolph Assoc.
 Central Wire
 Kanebridge Corp.
 GF&D Systems, Inc.
 XL Screw Corporation
 Allstar Fasteners
 Computer Insights
 Stelfast
 Brighton Best Int'l
 World Washer Mfg.

MWFA sponsored betting holes were won by Bob O'Brien - *Certified Fasteners & Industrial Supply* and Gary Kautz - *Allstar Fasteners*

Ball Drop sponsored by MWFA won by two balls landing in the hole Clayton Allen - *Buckeye Fasteners* and Jim Sullivan - *Abbott Interfast*. 

MID-WEST FASTENER ASSOCIATION GOLF OUTING EAGLEWOOD GOLF RESORT, ITASCA, IL - JUNE 6, 2018





AIRBAGS LIKE THESE FROM TAKATA WERE THE CAUSE OF NUMEROUS DEATHS - MILLIONS OF RECALLED AIRBAGS, AND BILLIONS OF DOLLARS IN FINES. THE CULPRIT - FRAUD.

This ultimately sent shockwaves in brand confidence to Takata's OEMs, which included Toyota, Honda, and many other car manufactures. In the US alone, over 42 million vehicles faced recall. Additionally, Takata was ordered to pay \$1 billion USD in fines related to its fraudulent business practices, with significant damage to the OEMs brand reputation and lots of administrative and logistical nightmares. Just this year, the 112-year old Kobe Steel was in growing hot water for, among many other scandals, falsifying documentation on testing of the strength and durability of its aluminum and copper products. This latest scandal has deep impacts that the OEM level, as large multinationals were affected, such as Toyota, Hitachi, and Subaru.

Fraud Isn't Just A Problem for the Multi-National Giants

With shocking headlines and household OEMs affected, it's easy for the average manufacturer to think that they are immune to these types of supplier complications. Unfortunately, that is not entirely the case. In the US alone, the manufacturing industry is generally highly susceptible to fraud cases, with over 10% of all fraud cases reported to The Association of Certified Fraud Examiners (ACFE) in 2016. Additionally, ACFE estimated that the median loss for manufacturers that fell victim to fraud was \$194,000, in direct monetary

losses. This does not include lost productivity or loss of confidence of consumers. Is this a liability that your company can budget for and bounce back?

How Can The Average OEM Protect Themselves?

Keeping brand trust and avoiding application and end-use failure of safety-critical applications is supremely important in any brand, and OEMs should take the lessons learned from companies like Toyota to heart by demanding accountability and accurate and transparent documentation in order to minimize risk and ensure traceability of their suppliers' products.

LBMC, a Tennessee-based accounting and consulting firm has found that companies who implement relatively inexpensive and painless techniques to fight fraud have experienced losses that were 54% lower and detected fraud in half the time. The techniques referred are things such as management reviews and data monitoring and analysis. If that's the case, why isn't a resolution more widespread through the manufacturing industry? The answer is often times due to complacency and blind trust in most OEM internal practices. We will explore the pitfalls of the existing ways OEMs fight manufacturing fraud and propose improved guidelines to curb this pervasive problem.

Existing Problems That Enable Fraud

Most often, many purchasing departments and OEMs will brush off talk of falling victim to potential fraud by telling themselves it can't happen to them because they have a system of checks in place. We will focus the critique on why existing fraud detection systems break down within OEMs in two major themes. The first reason is due to blind trust in a supplier, as-in reliance on self-reporting in order to meet any set of self-imposed or regulatory manufacturing controls. The second reason is often times a direct result of the former, complacency. The following will discuss the major risks with these two pitfalls, and why you may be at risk of fostering these two practices in your firm, knowingly or unknowingly.

NO NEED TO LOOK OFFSHORE!!!

MASTER SEAL® Bonded Washers are more than just washers

- Features Include: Standard and customized shapes stamped daily.
- Quality elastomerics, meeting the need for elasticity, memory, temperature extremes, chemical, ozone and sunlight-resistance.
- Conical design directs flow of facing materials to form a seal conforming to both fastener and sealing surface.
- Full-face design cushions fragile surfaces and minimizes vibration.
- Inside diameter sizes from 1/4" to 2" and corresponding metric range, choice of many backing materials, various colors, thicknesses, finishes and various facing materials.



aztec
washer
company

PH: (858) - 513-4350 FAX: (858) - 513-4305
www.aztecwasher.com • info@aztecwasher.com

We Manufacture Trust.

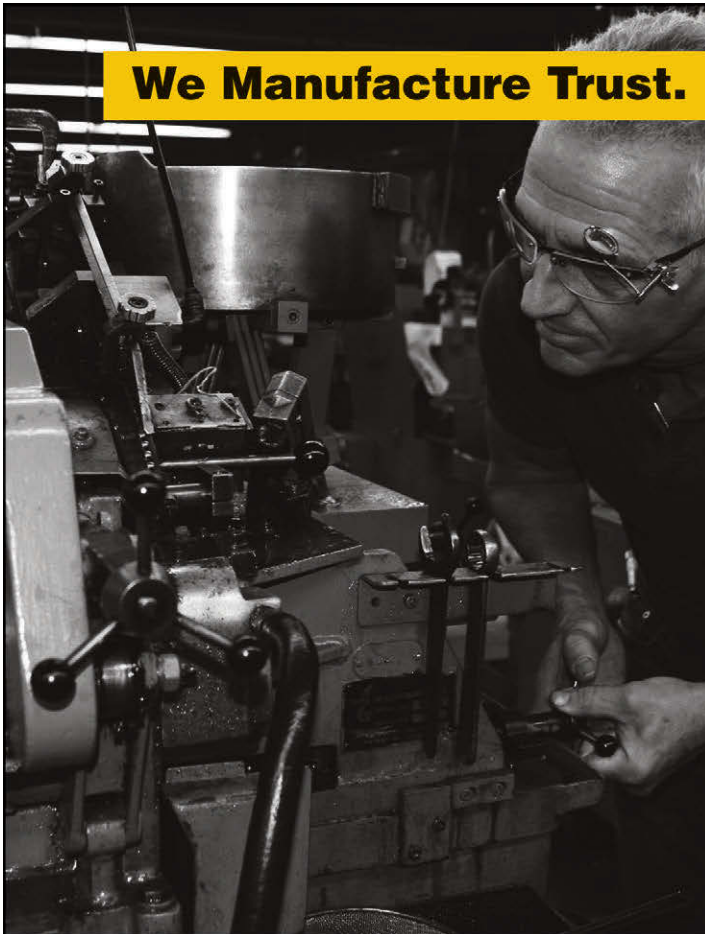

When superior quality is critical and rapid response is a necessity, Crescent is the smart call.

You're up against it—schedule changes by customers, demands for quick quotes and they needed it "yesterday." Who do you call? Crescent. The company you can trust and depend on. We know our product inside out because we only sell fasteners we manufacture—with a range of fastener sizes (now 000-3/8), in various styles and materials. Need standard, military, or specially designed parts by your end users? We have you covered. Our certified AS9100 Quality Program assures you delivery of the quality parts you expect—when you expect them. We also deliver quality with a well-trained, knowledgeable staff—they help solve problems, get answers, deliver fast quotes and provide superior customer service. Since 1960 Crescent has been manufacturing trust—call us at crunch time to see for yourself what we can do—(860) 673-2591 or visit us at www.crescentmanufacturing.com.



CRESCENT MANUFACTURING

700 George Washington Turnpike, P.O. Box 1350, Burlington, CT 06013
phone 860 673 2591 fax 860 673 5973
sales@crescentmanufacturing.com www.crescentmanufacturing.com

SPIROL HOW DEFLECTION RANGE AFFECTS THE PERFORMANCE OF DISC SPRINGS from page 98**Dynamic Load**

Dynamically loaded Disc Springs can be divided into two general categories:

- [1] Limited fatigue life where Disc Springs achieve 10,000 to 2,000,000 cycles
- [2] High fatigue life where Disc Springs are able to withstand more than 2,000,000 cycles.



Processes such as shot peening may be used to increase the fatigue life of Disc Springs. Shot peening induces favorable compressive stress on the Disc's surface reducing crack propagation.

Residual manufacturing tensile stress occurs at the upper inside diameter edge of the Disc, shown as Point 1 in Figure 2:

During operation, this tensile stress changes to a compressive stress. Fatigue life is drastically reduced by this stress reversal. Keeping the Disc Spring under a constant preload at a minimum of 15% deflection eliminates these stress reversals and increases the life of the Disc Spring.

Importance of Pre-Load and Final Load**Pre-Load**

Initial loading of the Disc Spring accomplishes two objectives:

[1] In unloaded Disc Springs, residual tensile stress from manufacture occurs at Point I shown in Figure 2. Pre-loading the Disc changes the tensile stress at Point I to a compressive stress. Keeping the top of the Disc under compressive stress reduces risk of crack propagation. Variation from tensile to compressive stress severely limits the fatigue resistance of the Disc Spring. The Disc Spring must be pre-loaded to a minimum of 15% of total deflection to eliminate tensile stress.

[2] The Disc Spring seats as the initial applied force is distributed evenly about the periphery of the spring. Disc Springs are not 100% symmetrical, so

there is a slight increase in force as they are seated during pre-load. While this increase in force can be anticipated, it is not accounted for in force/deflection calculations.

Final Load

Increasing final load increases the amount of stress in the Disc Spring and results in lower fatigue resistance. As in any structural component, less deflection results in lower stress and longer life. Loading the Disc Spring past 75% of total deflection takes the Disc past the linear section of the performance curve (Figure 1), and stress can increase in a non-linear fashion leading to rapid loss of fatigue resistance. The lower the final load meeting design requirements, the greater the fatigue life. Fatigue life can be increased by decreasing deflection of the Disc Spring. If additional travel is required, Disc Springs may be stacked to provide more deflection without increasing stress on each individual Disc resulting in increased fatigue life.

**Summary**

Deflection range of the Disc Spring determines its predictability and endurance.

In static loading, theoretical stress calculations are not necessary provided deflection does not exceed 75% of full Disc deflection. Higher deflections result in high stress that will result in a loss of spring force. Understanding how deflection range impacts Disc Spring life is the key to determining fatigue life.

The guidelines provided are general in nature; therefore it is recommended that Application Engineers who specialize in designing and specifying Disc Springs be consulted to ensure that the performance requirements are met for each specific assembly. 

BINDER POSTS AND BARREL BOLTS.

SOLVED.



ALUMINUM



BLACK ALUMINUM



STEEL



STAINLESS STEEL



BRASS



RAPID ASSEMBLY PLASTIC

FOR ALL THE BINDER POSTS AND BARREL BOLTS YOU NEED, JUST CALL KINTER. We proudly offer what may be the industry's largest selection, including steel, stainless steel, aluminum, black aluminum, brass and plastic. Take advantage of our huge variety of material, diameters and lengths. And you can always count on us for massive in-stock inventory, low minimum quantities, same-day shipping and low prices. Contact a KinterCare Specialist and find out how easy it can be to source the items you need.

Ask us to send you our new Fastener Distributor Catalog!

Kinter[®]
SOLVED

800.323.2389 | kinter.com

BRICO INDUSTRIES BRIGHT NAME IN MIDWEST MANUFACTURING from page 104

The Business Edge™

Early on, Brico selected one of the premier fastener software packages to help them run their business. As things go, eventually they needed to upgrade to stay ahead of the curve.

When they were looking to upgrade their software program a few years back, they once again wanted to be on the cutting edge. They looked at all the popular choices, and even some custom programs. They chose The Business Edge™ (TBE), by Computer Insights, Inc.

Shop Floor Visibility

One of their key objectives was to enhance their manufacturing by improving visibility into activities on the shop floor. They needed to be able to see history, current production and future orders. Tom Tumbarello, President, explained the objective. He said, "With The Business Edge™ we can make much better decisions, both on buying raw material and on scheduling our deliveries. When buying wire, tooling or other raw materials, we can see all of the items used in each bill of materials and multiple uses for materials and tooling. Having this information available quickly and accurately allows faster decisions and gives us the ability to lower lead times. Our niche in the industry, is to have the shortest lead times. This enables our customers to react to their customers' demands faster and with fewer issues. We at Brico feel that customers can always find things cheaper, but late deliveries and quality issues are costs that customers don't deserve. Now that we have The Business Edge™ we can see all of the upcoming constraints, and make better decisions for better customer satisfaction."

Flexible Screen Formats

Each screen in The Business Edge™ can be tailored by the user to meet their specific needs. Below are a few examples of the way Brico is using these screens to their great advantage.

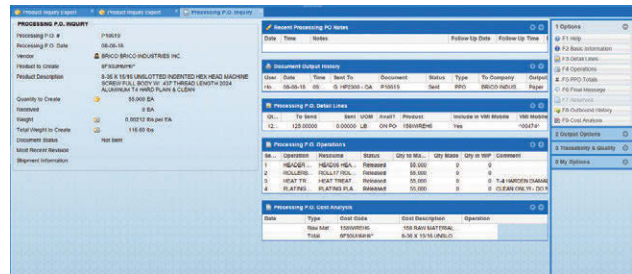

Production Inquiry

The Production Inquiry shows all the open sales and production orders along with the processing cost analysis.

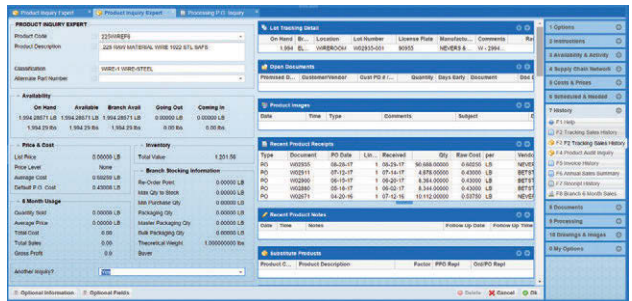

Product Inquiry Expert

The Product Inquiry Expert shows all product on hand by lot number and all commitments.

Product Code	Product Description	Branch Avail	Branch On Hand	Branch In Warehouse	Branch Coming In	Entity Avail
72WIREPK	072 RAW MATERIAL WIRE 1022 STL SAIP	299	299	299	0	0
80WIREPK	080 RAW MATERIAL WIRE 1022 STL SAIP	229	229	229	0	0
91WIREPK	091 RAW MATERIAL WIRE 1022 STL SAIP	0	0	0	0	0
94WIREPK	094 RAW MATERIAL WIRE 1022 STL SAIP	0	0	0	0	0
100WIREPK	100 RAW MATERIAL WIRE 1022 STL SAIP	-123	121	121	0	0
110WIREPK	110 RAW MATERIAL WIRE 1022 STL SAIP	0	0	0	0	0
110WIREPK	110 RAW MATERIAL WIRE 1022 STL SAIP	0	0	0	0	0
113WIREPK	113 RAW MATERIAL WIRE 1022 STL SAIP	0	0	0	0	0
118WIREPK	118 RAW MATERIAL WIRE 1022 STL SAIP	-1,453	887	887	0	0
118WIREPK	118 RAW MATERIAL WIRE 1022 STL SAIP	0	0	0	0	0
120WIREPK	120 RAW MATERIAL WIRE 1022 STL SAIP	0	0	0	0	0
131WIREPK	131 RAW MATERIAL WIRE 1022 STL SAIP	0	0	0	0	0
131WIREPK	131 RAW MATERIAL WIRE 1022 STL SAIP	1,682	1,682	1,682	0	0
132WIREPK	132 RAW MATERIAL WIRE 1022 STL SAIP	0	0	0	0	0
139WIREPK	139 RAW MATERIAL WIRE 1022 STL SAIP	11,841	12,641	12,641	0	0
139WIREPK	139 RAW MATERIAL WIRE 1022 STL SAIP	7,654	7,654	7,654	0	0
140WIREPK	140 RAW MATERIAL WIRE 1022 STL SAIP	-11,254	2,045	2,045	0	0
147WIREPK	147 RAW MATERIAL WIRE 1022 STL SAIP	0	0	0	0	0
147WIREPK	147 RAW MATERIAL WIRE 1022 STL SAIP	0	0	0	0	0
151WIREPK	151 RAW MATERIAL WIRE 1022 STL SAIP	3	3	3	0	0
151WIREPK	151 RAW MATERIAL WIRE 1022 STL SAIP	0	0	0	0	0
155WIREPK	155 RAW MATERIAL WIRE 1022 STL SAIP	1,962	10,527	9,747	0	0
155WIREPK	155 RAW MATERIAL WIRE 1022 STL SAIP	0	0	0	0	0
164WIREPK	164 RAW MATERIAL WIRE 1022 STL SAIP	0	0	0	0	0
164WIREPK	164 RAW MATERIAL WIRE 1022 STL SAIP	8,973	8,973	8,973	1,029	0
172WIREPK	172 RAW MATERIAL WIRE 1022 STL SAIP	0	0	0	0	0
172WIREPK	172 RAW MATERIAL WIRE 1022 STL SAIP	0	0	0	0	0
176WIREPK	176 RAW MATERIAL WIRE 1022 STL SAIP	42	42	42	0	0
176WIREPK	176 RAW MATERIAL WIRE 1022 STL SAIP	0	0	0	0	0
183WIREPK	183 RAW MATERIAL WIRE 1022 STL SAIP	18,725	18,725	18,725	0	0
183WIREPK	183 RAW MATERIAL WIRE 1022 STL SAIP	0	0	0	0	0
184WIREPK	184 RAW MATERIAL WIRE 1022 STL SAIP	0	0	0	0	0
184WIREPK	184 RAW MATERIAL WIRE 1022 STL SAIP	0	0	0	0	0
191WIREPK	191 RAW MATERIAL WIRE 1022 STL SAIP	0	0	0	0	0

Quick Lookup

This quick lookup provides an instant snapshot of all the production orders that are affecting raw material requirements.

distributornews

J.W. Winco, Inc., A Ganter Company, a leading supplier of standard industrial machine components, offers GN 6342 Washers with Axial Friction Bearing, Stainless Steel.

Used in connection with such items as Winco's Adjustable Levers (GN 300 Series) or Wing Screws (GN 835 Series) with threaded studs, the RoHS compliant washers with axial friction bearing almost double the clamping force due to lower area friction. Also, the mounting contact surface acts gently on the piece being clamped.

The washer body is stainless steel, European Standard No. 1.4305 (AISI 303) and the sliding disk is slightly greased, temperature resistant to 250 °F (120 °C), and made from Polyamide 46 glass fiber reinforced technopolymer plastic.

JW Winco offers an extensive selection of inch and metric size adjustable levers, cabinet U-handles, plastic and steel hinges and locking mechanisms, revolving and retractable handles, hand wheels, hand cranks, tube connection and conveyor components, inch and metric construction tubing, shock absorption mounts, leveling mounts, hand knobs, spring, ball and indexing plungers, jig, fixture and fastening components, retaining magnet assemblies, toggle clamps, metric casters and

wheels, universal joints, oil sight glasses, and metric tools for the industrial and commercial equipment industries.

FASTENERS DONE RIGHT



//JACKPOT



Let us help with all your fastener needs
www.wclco.com | 800.331.3816

Proud to be AS9100 Rev. D certified

Knowledge	Integrity	Quality
Creative Solutions	Engineering	Inventory
Supply-Chain Partners	Packaging/Kitting	



JW Winco, which is ISO 9001:2015 certified, is located in New Berlin, Wisconsin, with sales locations in Canada and Mexico.

For more information, contact J.W. Winco at 1-800-877-8351, by fax at 1-800-472-0670 or via e-mail at sales@jwwinco.com. JW Winco's new website, with improved 3D CAD and online buying, is viewable at www.jwwinco.com.

DISTRIBUTION ONE DISTRIBUTOR TOOLS FOR HARNESSING THE POWER OF AMAZON *from page 60*

Warehouse and Inventory

Success on Amazon hinges on the accuracy of your inventory. ERP-ONE+ precisely manages your real-time inventory levels and reconciles changes to stock due to local storefront sales. Having this inventory auto-update capability is crucial to successful marketplace selling as Amazon does not tolerate order cancellation rates over 2.5% due to out of stock items. The flow of accurate information between ERP-ONE+ and Amazon ensures the availability of salable items keeping both Amazon and your customers happy.

Customer Expectations

Customer happiness is key. A positive customer experience is becoming synonymous to online sales growth. In fact, the survey found that 74% of respondents view the impact of Amazon as resulting in customers demanding faster delivery times for orders. Moreover, 97%

of wholesale distributors agree that business process automation allows them to better service customers. With ERP-ONE+ accurately controlling inventory levels, managing orders, reducing turnaround times, and managing shipments, there really is little left to chance for your customers.

Process automation is a profound revenue driver for wholesale distributors. ERP-ONE+ software delivers the reduced costs, decreased errors, and comprehensive functionality needed to successfully expand sales on Amazon. Leveraging the power of online retailers through ERP-ONE+ software connectivity, you too can stand as the next giant in the jungle.

Learn more about ERP-ONE+ and Amazon integration at distone.com/amazon-for-fasteners or contact us at info@distone.com. 

[1] 2017 Berg Research surveyed 409 respondents from medium and large US wholesale distributors and manufacturers to examine the forces of technology and process automation.

DISTRIBUTION ONE

MID-WEST FASTENER ASSOCIATION - FASTENER TECH™ '19

PO Box 5, Lake Zurich, IL 60047 TOLL-FREE 1-800-753-8338 TEL 847-438-8338 EMAIL mwfa@ameritech.com WEB www.mwfa.net

REGISTRATION FORMS & FLOOR PLANS ARE ONLINE by Nancy Rich

FASTENER TECH™ '19

FASTENER TECH™ '19 - the seventh staging of "The All-Fastener-Industry Event in the Heart-of-the-Fastener Industry," is pleased to announce that exhibitor registration is open and forms are available online at www.mwfa.net and www.fastenertech.com/fastenertech.asp. In addition, the official Floor Plan is posted online for booth selection.

The event is scheduled to take place in Rosemont (Chicago), IL, USA, June 3 to 5, 2019 at the Donald E. Stephens Convention Center. **FASTENER TECH™ '19** will offer attendees and exhibitors a valuable, cost-effective and easy-to-attend event that provides benefits to fastener manufacturers, distributors, users and suppliers. **FASTENER TECH™** is a biennial event, and once again in 2019 it will be co-located with SUR/FIN®, the annual conference and exhibition for surface finishing professionals, which is organized by the National Association for Surface

Finishing, Washington, DC, USA, www.nasf.org.

FASTENER TECH '19 will feature an Exhibition, Education Seminars, an All-Industry Reception, and other networking opportunities. Preliminary schedule:

- ▣ Education Seminars: June 3, 4 and 5, 2019
- ▣ Exhibition: June 4 and 5, 2019
- ▣ All-Industry Reception: June 4, 2019

As a trade event, **FASTENER TECH™ '19** will be unique on several fronts, including the following: the relatively low-cost and ease-of-exhibiting at and attending the show, the all-industry focus, the heart-of-the-industry location, and a high level of participation from fastener industry associations.

Additional **FASTENER TECH™** details and a flipbook edition of the "2017 Exhibition Directory" are available at: www.fastenertech.com/fastenertech.asp. Floor plan and registration form for Fastener Tech also available at www.mwfa.net and www.fastenertech.com 

HANGER BOLTS?

Hangerbolt.com of course

What about:

PINS?

STUDS?

DOWEL SCREWS?

Hangerbolt.com of course

800-537-7925

MADE IN THE USA!

BAY SUPPLY

A DIVISION OF BAY FASTENING SYSTEMS

30 Banfi Plaza North, Farmingdale, NY 11735

TEL 516-294-4100

FAX 516-294-3448

EMAIL info@baysupply.com

WEB www.baysupply.com

Bay Supply

BAY SUPPLY IS NOW A FULLY AUTHORIZED DISTRIBUTOR FOR FAR FASTENERS

Bay Supply, the largest engineered fastening supply warehouse in the United States, is pleased to announce it is now an authorized distributor of the entire line of FAR products in the U.S.

Since 1957, FAR has been a leading Italian manufacturer of high-technology fasteners. FAR's headquarters are in Bologna and it operates a warehouse in Milan.

Known for its commitment to reliability, service, quality, and maximum efficiency and performance service, FAR delivers a variety of outstanding fastening products, including:

- **Blind Rivets:** FAR's range of blind rivets covers several hundred standard articles. Special rivets can be manufactured according to drawing upon request.

- **Blind Rivet Nuts:** Offered in steel, stainless steel, and aluminum for many applications, FAR's blind rivet nuts are highly resistant and are of practical and quick use.

- **Riveting Tools:** More than 30 models, including manual, pneumatic, and battery-powered, are available and suitable for fastening blind rivets or blind rivet nuts.

As an authorized distributor of FAR's entire line, Bay Supply is able to offer customers another high-quality option when they consider their fastening needs.

"FAR has a reputation of producing top-of-the-line blind rivets, blind rivet nuts, and riveting tools," said Clifford

Bernard, CEO and President of Bay Supply. "By becoming an authorized distributor of FAR's entire line, we can offer these fine products to customers and build the company's reputation in the United States. We are proud of this partnership and look forward to the benefits it will bring our customers."

Bay Supply offers one of the largest warehouse and inventory management systems in the fastener industry to serve customers with instant order processing and tracking. Every item page on our website, www.baysupply.com, includes important information such as engineering specifications, data sheets, product attributes, tool manuals, manufacturer catalogs, and instruction videos; supplementary info is available in our resource library.

We also offer a helpful blog and two other free resources:

- **The Essential Guide to Blind Rivets:** This e-book details the industries and applications that benefit from blind rivets, specifications, the history of pop rivets, best practices for ordering through a distributor, and more.

- **Rivet Guns: A Comprehensive Guide for Choosing the Right Tool for Your Job:** This e-book details the types of rivet guns available for any application, typical use cases, considerations to make before purchasing a rivet gun, common pitfalls and misuse, maintenance and repair tips, and more. 

DÖRKEN **MAGNI** **YUKEN**
HIGH CORROSION DIP SPIN COATINGS



BLACK OXIDE PASSIVATION ZINC PHOSPHATE
CLEANING PICKLING SORTING PACKAGING

www.swdinc.com



P: (630) 543-3003

F: (630) 543-3028

HOME OF THE
BLACK OX



I told you we should have replaced the washers with Zago Sealing Fasteners.



PCC

PRODUCT COMPONENTS CORP.

The Plastic
Fastener &
Component
Specialists

PCC is a woman-owned and operated supplier of high quality plastic fasteners



- SCREWS
- NUTS
- WASHERS
- SPACERS
- INSULATORS
- PIPE PLUGS
- THREADED ROD
- CABLE TIES
- BALLS
- X-MAS TREE CLIPS
- ...AND MANY MORE

OVER
50
YEARS
EXPERIENCE

Available in a variety of plastics including Nylon, PVC, PTFE, Polypropylene, Acetal, Polycarbonate and other materials.

SEND US YOUR PRINTS - WE QUOTE NON-STANDARD PARTS

825 Arnold Drive, Bay 7, Martinez, CA 94553

Tel: 925-228-8930 | Fax: 925-228-8933

sales@product-components.com

www.product-components.com

call us toll-free **1-800-336-0406**



MENTION THIS AD AND RECEIVE **5% OFF** YOUR NEXT STANDARD CATALOG ITEM ORDER

Hillsdale Terminal

BARE | NYLON | 3PC NYLON | CRIMPING TOOLS | CABLE TIES
WIRE | TERMINAL KITS | HEAT SHRINK TERMINALS

WIRE RANGE: 22-18, 16-14, 12-10, 8, 6, 4, 2



Call for Free Catalog & Pricing

1-800-447-3150

Fax 517-437-0797

www.hillsdaleterminal.com

250 Industrial Drive, Hillsdale, MI 49242

distributornews

Victory Bolt & Specialty, Inc. is proud to celebrate 30 years in business. Since 1988 our customers have chosen Victory Bolt & Specialty for fasteners of all types and material as well as pole line hardware with a high concentration in stainless steel because of the service and quality that we bring to the fastener industry. Victory Bolt & Specialty, Inc. is headquartered in Indian Trail, North Carolina with customers and shipping locations across the US, Mexico, Canada, Europe, Poland, and Brazil.

"It is very surreal and somewhat overwhelming to think back on all the things that have happened over the last 30 years. Both good and not so good. To start this company with no fear and no money is the craziest thing I could have ever done. With an attitude that I could do it and a credit card to max out at \$3,000.00. My journey, THIS journey began. To GOD be the glory without him we wouldn't be here today celebrating this milestone. And remember - if you think you can you can, if you don't you won't." - Renee Breazeale, CEO of Victory Bolt & Specialty, Inc.

"30 years in business in a competitive industry would not be possible without the continued loyalty of our customers, our vendors, all of our amazing staff, and the support of our family." - Ray Breazeale, President of Victory Bolt & Specialty, Inc.

Victory Bolt offers an extensive selection of fasteners for the Construction, Marine, Public Works, Utility, Solar, and Medical industries including anchor bolts, nylon products and cable ties, hex cap screws, nuts, rivets, screws, socket products, studs, washers, poleline hardware, specials and much more. When you need to safely secure anything and everything, shop Victory Bolt for all the fasteners and other products you need to get the job done. Victory Bolt and Specialty, Inc. is the nation's largest stocking distributor of Eagle Shield™, chrome-over-stainless steel fasteners and one of the largest stocking distributors of import and domestic fasteners, with manufacturing capabilities on select items.

For more information, contact Victory Bolt & Specialty, Inc., 4812 Unionville Indian Trail Rd, Indian Trail, NC 28079. Tel: 704-882-8030, Email: info@victorybolt.com or visit www.victorybolt.com.

PAC-WEST FALL CONFERENCE - GROUSE MOUNTAIN LODGE WHITEFISH, MONTANA - AUGUST 8-11, 2018

PHOTOS COURTESY OF
GREG CHRISTENSEN



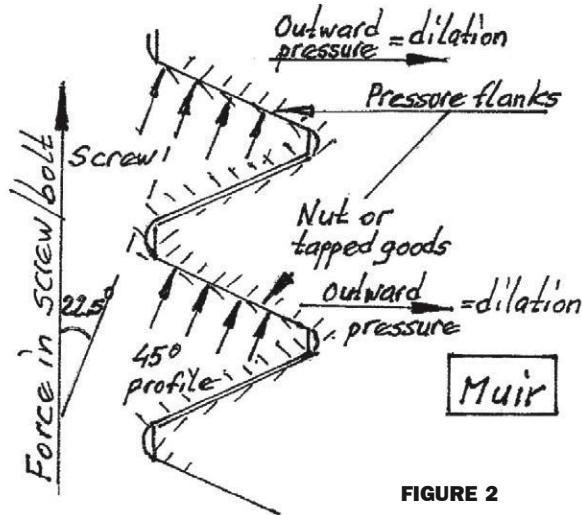

FIGURE 2

As an example of how to lower the risk of dilation, figure 2 shows the Muir profile with a 45° top angle. In this case we still have a dilation effect caused by the pressure on the load bearing flanks. But, since we now have a 22.5° angle to the axis of the bolt/screw it will cause a lesser amount of outward pressure. Keep in mind that this is not a common standard thread and should be very carefully and seriously considered (and probably avoided).

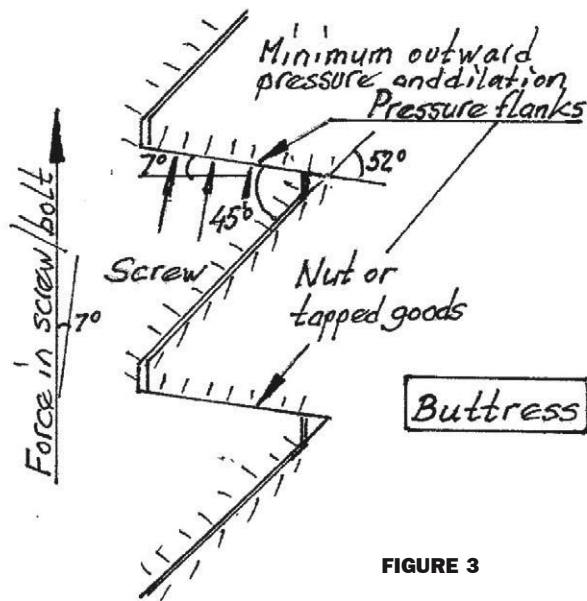

FIGURE 3

For very sensitive materials to be tapped and screwed together, and to add a very minimum of outward pressure we can use the Buttress thread as shown in

figure 3. There is also a “Buttress Special” where the 7° angle is eliminated all together and pressure flank is perpendicular (normal) to the bolt axis. This type of thread is used for very special fasteners in applications like turbines and also lately for medical implants where radial loads must be kept to an absolute minimum amount.

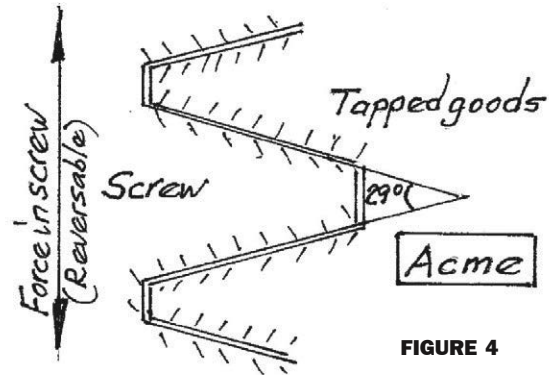



FIGURE 4

The last group I'd like to discuss is the Acme profile. This is not a thread type for fasteners in traditional bolted joints, even if I have seen it being used in that context. Maybe some engineers remembered that the common textbooks in engineering college often combine the chapter (-s) on fasteners with so called “Power-screws” where the Acme type is also included. In my humble opinion, Acme and the various rectangular thread profiles should be used in reversible load application (as power-screws) like closing and opening of valves, as lead screws for various movements and similar cases.

Conclusion

With more and more industries (in all countries) choosing up-to-date thread standards like ISO 68, maybe our grand-children will have an easier time with this chaotic thread family. I hope you remember my Link article about “Thread Mis-matches” a few years ago, keep it handy for the next 30-40 years if you still have it. It is particularly important for the US market since we now have about a 50-50 relationship between using inch and metric fasteners. 



KEY BELLEVILLES, INC.

We are the largest Disc Spring Manufacturer!

- *Complete size range from .236" to 36" O.D. & 3" Thick*
- *Largest Raw Material and Finished Inventory in the World*
- *We manufacture Metric Parts to DIN Specs*
- *Complete Line of Stainless and Inconel Parts*
- *10,000 Different Sizes in Stock*

Call toll free from anywhere in the U.S. and Canada at:

Phone: 1-800-245-3600 • Fax: 1-800-847-1672

Key Bellevilles, Inc.

100 Key Lane • Leechburg, PA 15656-9531 U.S.A.

Phone: 724-295-5111 • Fax: 724-295-2570

www.keybellevilles.com • e-mail: sales@keybellevilles.com

*Visit Our Website
or Call for a FREE
Engineering CD*

The Original.

The Best.

Your source for Serrated Safety Washers,
DIN 6796 Heavy Duty Load Washers,
High Load Safety Washers and DIN 2093
Belleville Disc Springs, since 1908.

SCHNORR[®]
DISC SPRING ENGINEERING

1665 Highland Dr, Suite E
Ann Arbor, MI 48108

P: 734-677-2683
F: 734-975-0408

sales@schnorr.com
schnorr.com



Come see us at
the International
Fastener
Expo
BOOTH 3355



Same day
shipping for
most parts

HAVE YOU VISITED OUR NEW WEBSITE?

GUY AVELLON WHAT FASTENER DISTRIBUTORS NEED TO KNOW ABOUT THE PROCESSING OF STEEL FASTENERS *from page 126*

During the heat treatment process, cap screws are brought to a controlled red hot temperature of approximately 1666°F (908°C) in gas fired ovens. This temperature is usually above the upper critical temperature in order to form austenite. Time and controlled temperatures will produce steel with very high hardness: some steels will achieve a hardness up to 55 HRC (Hardness, Rockwell C scale). As a finished product, this is not desirable as the steel is brittle and further processing is necessary.

Special monitors in the gas fired ovens control the natural gas and oxygen mixture to control the free carbon atmosphere to avoid unintentional carburization or decarburization. Carburization would produce excessive surface hardness from the addition of carbon, while decarburization would rob the threads of their strength by removing carbon from the surface of the thread crests. The importance of exact temperatures, times and cooling

rates are extremely critical, which is why these “thresholds” are called upper and lower critical temperatures. When steel is heated above its critical temperature, its crystalline structure changes to austenite. As the steel parts are withdrawn from the furnace, the parts begin to cool very rapidly. It is when the steel reaches a temperature of 1333°F (732°C) that it becomes necessary to control the cooling rate. This temperature is the ‘lower transformation line’, also known as the Eutectoid Temperature. It is the same for all iron and steels.

The goal of hardening the steel is to produce a fine grain, fully martensitic microstructure, as it is much harder than austenite. Martensite is formed upon cooling. The minimum cooling rate (°F or °C per second) that will avoid the formation of any softer products of transformation is known as the critical cooling rate.

The next phase is the controlled quenching of the steel. 

GUY AVELLON



LINK

IT'S ALMOST THAT TIME OF YEAR...
We look forward to seeing you in Vegas!

MANDALAY BAY CONVENTION CENTER
LAS VEGAS, NV

INTERNATIONAL FASTENER EXPO
BOOTH #3441

OCTOBER 30 THRU NOVEMBER 1

HIT THE JACKPOT

 WWW.LINKMAGAZINE.COM

AMERICAN IMPERIAL SCREW CORP.

PUSH ON HATS (Axle Caps)



Self Treading Locknuts & Washers



Push-On Retainer Fasteners



Regular Lock Nuts



Push-On Bolt Retainers



Wing Nuts



Regular Washer Locknuts

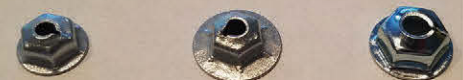

Brass Knurled Thumb Screws

Available

- Plain
- Nickel
- Black

or any color



DISTRIBUTOR FOR:

ITW Shakeproof-SIP Push on Fasteners: Push on Hats (Axle Caps), Push on Retaining Fasteners, Washer Faced Lock Nuts and Self Threading Lock Nuts

Simpson Strong-Tie Anchors: Adhesives, Mechanical Anchors

Call us at 800-431-2391 or Fax 845-354-4377

WWW.DISCOUNTSCREWS.COM • P.O BOX 234, POMONA, NY 10970

I grew to favor the Quarter Pounder. Back then it was easy for me to order, as the menu included a Quarter Pounder (without cheese) and a Quarter Pounder with cheese. I only had to order the non-cheese version to get what I wanted. Fast forward and twenty years ago some bright individual decided that they should drop the no cheese version and just sell the Quarter Pounder with cheese. They could serve individuals like me by simply accommodating my requirement to leave the cheese off. This arrangement suited me fine. Unfortunately, I discovered that about every third time I drove through a McDonalds and placed my special order, I received a burger with cheese on it. This was especially frustrating after I was a mile or more down the road and discovered the mistake. I simply had no good options to remedy the situation.

On about the umpteenth time this happened to me I resolved to no longer purchase Quarter Pounders from McDonalds and I haven't had one in over seven years. Although this is probably better for my health, McDonalds lost a customer, who now has five of his own children, and the potential of being a large and regular consumer of their Happy Meals and, yes, Quarter Pounders without cheese.

When a customer leaves or replaces you because of poor quality it is likely that they will never be a customer again.

The Impact of a Quality Spill

Quality spills will happen from time to time. Even the best distributor needs to understand that they will experience some quality spills and they should be prepared for this inevitability. I cannot emphasize strongly enough, though, that the way your organization handles these spills will determine, at least in part, whether the outcome is a good one or bad one.

Handling a quality crisis is never an easy task. Everyone is on edge so that it is easy for tempers to flare and unreasonable requests to be made. In fact, depending on the nature of the spill, tensions and emotions may be running at all-time highs. Such situations often escalate into a defensive battle between "opponents" when all parties would be better suited working together as "partners" to

resolve and permanently fix the problem at-hand.

At one point in my career I was in charge of our company's quality assurance department. Shortly after taking on this new role we were faced with a significant quality spill. It would take several months and several hundred thousand dollars to resolve the issue. Our customer, a tier to an OEM, experienced significant pressure from their OEM customer to resolve the issue, which they turned around and passed on to us. It is fair to say that this was a defensive and sour incident all the way through. When it was over our customer dumped a large bill on us and demanded that we pay it. Things sort of went south from there and although we were able to come to a resolution that satisfied everyone, our relationship would never be the same and within five years they had entirely replaced us as a supplier.

Fast forward about half a year and, once again, we were engaged in a problem. This one was even more severe, as it involved a potential safety critical part. It was handled, however, entirely differently and both parties worked together with a laser focused goal to resolve the issue and never let it happen again. Unlike the first problem which ended poorly, this spill had every potential of playing out in a similar fashion. However, because of the positive way things were handled, within five years this customer would grow to be our largest.

The moral of the story is that the way an organization handles quality spills will greatly influence the eventual outcome with a relationship to that customer.

Summary

In summary, understanding what quality means to your organization is a key first step in defining how you will allow quality to impact your organization. Clearly, when quality is poor and when response to quality spills is disjointed, slow, and sloppy, it will have a lasting and negative impact. Perhaps worse than the monetary drain that poor quality has on an organization is the loss of reputation and departure of customers to other suppliers. For these reasons fastener distributors can't afford to ignore the importance of quality and do it poorly and instead should set quality as one of the highest company priorities. 

ISC

INTERCONTINENTAL SALES CORPORATION

16 PRODUCT LINES WITH 1 PURCHASE ORDER - YOUR ONE STOP SHOP

WHOLESALE OF FASTENER & BUILDING RELATED PRODUCTS

ANCHORS
CABLE TIES
WASHERS & SCREWS
HANGERMATES™ PIPE SPIKES™ & SAMMY SUPER SCREWS™

CONCRETE SCREWS

CONICAL & EZ ANCHORS & KITS
RIVETS/RIVET NUTS & TOOLS
THREADED ROD & ACCESSORIES
STRUT & ACCESSORIES
GREEN GROUNDING SCREWS
PIGTAILS & WIRE NUTS



YOUR CONCRETE SCREW SPECIALISTS

BLUE & PAINTED | 410 & 304 STAINLESS STEEL
HEX HEAD AND FLAT HEAD



NO MINIMUM | BULK & PACKAGE AVAILABLE
SAME DAY SHIPPING | PRIVATE LABELING

910 SW 12th Ave, Pompano Beach, FL 33069 TEL 800-741-4278 | 954-943-1939 | FAX 800-892-0983 | info@isc-sales.com www.isc-sales.com



for EVERYTHING Stainless

SHACKLES EYE BOLTS
TURNBUCKLES CHAIN
PAD EYES WEBBING
HOOKS & CLIPS RIGGING



Suncor Stainless, Inc. • 70 Armstrong Road • Plymouth, MA 02360
tel. 800 394-2222 • info@suncorstainless.com • www.suncorstainless.com

NATIONAL FASTENER DISTRIBUTORS ASSOCIATION

3020 Old Ranch Parkway #300, Seal Beach CA 90740

TEL 562-799-5509 FAX 562-684-0695 EMAIL nfda@nfda-fasteners.org WEB www.nfda-fasteners.org

KELLY COLE ELECTED NFDA PRESIDENT FOR 2018-2019 by Vickie Lester



Kelly Cole of Hayes Bolt & Supply (San Diego, California), was elected as the 2018 - 2019 president of the National Fastener Distributors Association.

Dan Zehnder of Trinity Logistics Corporation (Waukesha, Wisconsin) will serve as vice president, Bruce Hayes of Sems &

Specials (Rockford, Illinois) as associate chair and Kevin Miller of Bamal Corporation (Charlotte, North Carolina) will remain on the Board as immediate past president.

Four new Board members were elected to serve on the NFDA Board: Adam Derry of Field (Machesney Park, Illinois), Keven Simmer of Wurth DMB Supply (Des Moines, Iowa), Scott Somers of Mid-States Bolt & Screw Company (Flint, Michigan), and Bryan Wheeler of Star Stainless Screw (Wood Dale, Illinois).

Continuing on the NFDA Board are Rich Megliola of Vertex Distribution (Saint Charles, Illinois), Doug Ruggles of Martin Fastening Solutions (Florence, Alabama), and Jun Xu of Brighton-Best International (Santa Fe Springs, California).

The new Board was introduced at the NFDA 2018 Annual Meeting, held June 5-7, in Chicago, Illinois. The annual meeting also included Executive Sales Planning Sessions® and an economic update presented by Alan Beaulieu of ITR Economics.

Tribute was paid during the NFDA annual meeting to retiring Board members Kevin Godin of AFC Industries (Fairfield, Ohio), Adam Pratt of Sherex Fastening Solutions (Tonawanda, New York), Jennifer Ruetz of AIS-All Integrated Solutions (Franksville, Wisconsin), and

Marc Strandquist of Wurth Industry of North America (Greenwood, Indiana).

During the annual business meeting, Kelly Cole gave an update on the association's activities during the past year and plans for the coming year, with a message of inclusion and a goal of reducing fragmentation that currently exists among industry associations.

Thirteen new members were introduced:

- ▣ Aero Space Fasteners & Electronics
- ▣ Applied Design & Fastening Solutions
- ▣ BTM Manufacturing
- ▣ Circle Bolt & Nut Co., Inc.
- ▣ Creative Assembly Systems, Inc.
- ▣ Fullco Industries, Inc.
- ▣ Hagerty Industrial Supply
- ▣ Mack Brooks Exhibitions
- ▣ Management Information Tools
- ▣ MF Supply
- ▣ Midland Metal Manufacturing
- ▣ Parker Fasteners
- ▣ Volt Industrial Plastics, Inc.

Many thanks go to the NFDA 2018 annual meeting sponsors:

Welcome Reception Sponsors

- ▣ Beacon Fasteners & Components
- ▣ Elgin Fastener Group
- ▣ Huron Automatic Screw Co.
- ▣ INxSQL Software
- ▣ Nucor Fastener
- ▣ Star Stainless Screw
- ▣ Vertex Distribution
- ▣ Wurth Industry North America

ALUMINUM FASTENER

For over 35 years, Aluminum Fastener Supply Company has been the USA's **only exclusive** aluminum supplier



Tower Bolts
Bus Bar Bolts
Sign Bolts & Post Clips
VPA 12-Point Screws
Finished Hex Nuts
Beveled Washers
Flat & Lock Washers
Threaded Rod
Threaded Studs

Carriage Bolts
Machine Screws
Wood Screws
Sheet Metal Screws
Thumb Screws
Hex Self-Drill (Tek) Screws
Binding Post & Screws
Hex Head Bolts *(plain and anodized)*
Hex Head Cap Screws *(plain and anodized)*

Stadium Seat Bolts
Machine Screw Nuts
Tamper Proof Nuts
Nylon Insert Lock Nuts
Wing/Acorn Cap Nuts
Square/Flange Nuts
Tamper Proof Fasteners
Standard Items
Special Print Items

IT'S WHAT WE DO.

6500 LINE ITEMS · SAME DAY SHIPPING

ALUMINUM FASTENER SUPPLY COMPANY

1-800-526-0341 | info@alumfast.com | www.aluminumfastener.com

4297 CORPORATE SQUARE, NAPLES, FL 34104 TEL: 239-643-4551 FAX: 239-643-5795

 Follow us on Twitter @AluminumFast

The warning requirement change will catch lot of previously compliant businesses by surprise, and that most likely will be the bounty hunters low hanging fruit starting in September 2018.

For the fastener supplier, regardless of where you are in the supply chain, the decisions regarding what to do about Prop 65 is essentially a risk management strategy. The risk has nothing to do with chemicals or cancer or reproductive harm. It has to do with not getting sued and with not doing something, or failing to do something that may open your supply chain partners to a prop 65 enforcement action.

As you develop your strategy use the available resources. Keep in mind, this article was written by a fastener consultant, not a lawyer. If this is the first you are hearing about Prop 65 or if you have not yet looked at your products and developed a Prop 65 strategy you should get started immediately. Consultation with an attorney or a Prop 65 compliance professional should be considered.

Lawyers will likely take a very conservative view and recommend that you protect yourself from the bounty hunters with warning labels. I take the opposite view. Know your products and your supply chain.

- Remove the Prop 65 chemicals that cause exposure from your products.
- Don't provide a warning for anything that does not actually require a warning.
- Do not use messages on packing slips as warning methods.
- Be sure any warning you provide meets the ironclad "clear and reasonable" Prop 65 form and format.

Here are some thoughts to help develop your Prop 65 Risk Management Strategy:

[1] We are not low-hanging-fruit for bounty hunters. Historically fastener suppliers have not been targets and if we take strong united action we won't be going forward. The Prop 65 website lists every lawsuit and we can research by company and chemical what they go after. So far, since 1986, and since these chemicals

have been listed, 10-20 years, it has not been us. If they were not suing us before they are not going to start now – unless we give them a reason. That reason could be non-compliant labels, not chemicals.

[2] Bounty hunters go after actual violations, either in exposure or labeling or both. They will not waste their time with us, unless we call unnecessary attention to our industry. If one large importer or major distributor decides to say - label stainless steel fasteners for nickel, then why are the others not labeling? That will attract attention and probably a test case.

[3] I do not believe that Californians are exposed to any of the chemicals of concern in any of our fastener products. Of course, that does not preclude a supplier from knowingly or unknowingly including something that is on the list in their products– lead in HDG coatings for example. Not knowing if the content is there or not, or if it actually causes exposure, they will want take a cautious stand and label the product. However, since this supposed possible exposure has never attracted attention before, it should not now unless we draw unnecessary attention to it. However, there is a recent prop 65 enforcement action for lead in HDG anchor bolts that demands our attention.

[4] Bounty hunters know who the vulnerable are and they know who will easily roll over. These are their targets. Any single supplier that is targeted will probably just pay the bill and start labeling or figure out how to stop using that chemical, regardless of actual guilt. If we, as an industry had a well drafted consensus on why those listed chemicals are not Prop 65 players then the bounty hunters will leave us alone.

[5] I propose we establish a coalition of suppliers to fund the deep research to see if my position is the right one or not. This would not be technically difficult and it may or may not involve some laboratory testing. On the other hand, if such testing is inconclusive or actually shows exposure above the safe-harbor limits – which are ridiculously low, then we open a can of worms best not opened.

Carver Consulting

Fastener consulting and CAD services

- Dynamic website content
- Illustrated Parts Breakdown
- Assembly exploded views
- Engineering drawings
- Product animations
- Patent Illustrations
- Technical bulletins
- Solid models
- Inspection
- Testing

We can take your sketch or sample part and provide a manufacturing-ready print in as little as one day.

We can produce a professional engineering drawing that will impress your customers, lower your cost, help your suppliers and keep everyone on the same page as your part gets quoted, sold, manufactured, inspected and shipped.

Don't let the lack of a good blue print hinder your sales opportunities!

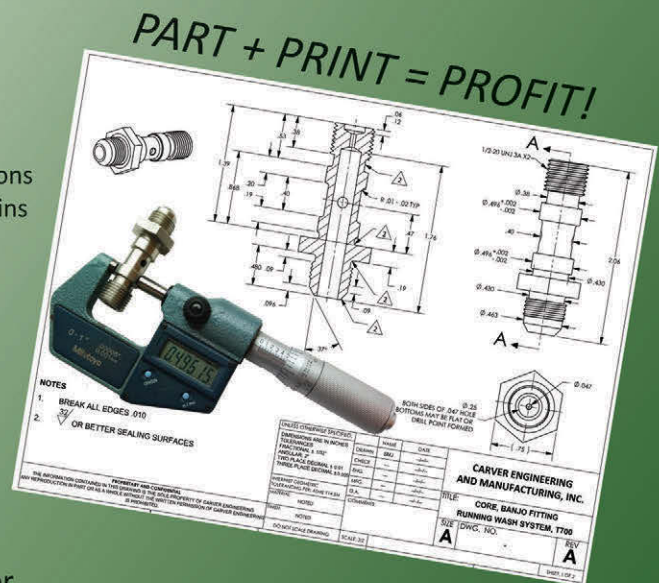

Ask us about an exciting opportunity to learn how to create your *own* models and drawings!

619.440.5888

www.carverem.com/drawings

1920 Cordell Ct. Ste. 101 El Cajon, CA 92020

CARMEN VERTULLO WHAT FASTENER SUPPLIERS NEED TO KNOW ABOUT CALIFORNIA'S PROPOSITION 65 from page 204

These are things the coalition would work out. Chances are there is plenty of research already available and we may not need extensive testing. You should consider testing your products for Prop 65 chemicals if you are unsure of their content.

[6] If you have not ever labeled your products or provided a Prop 65 warning before, and you have a good reason to not have done so you should not start now. If you start warning, and get it wrong, then you will be vulnerable. If you start labeling, then your customers will need to decide to label or not label. Labeling may actually make them more likely to become a target. Don't introduce unnecessary Prop 65 risk to your supply chain partners.

[7] If I were an attorney, I would say label, label, label. I understand their position. If you have an attorney or a compliance professional working on this issue I would be happy to have a conversation with them. Please

consider introducing us.

Through no desire or fault of my own I have become reasonably well informed on Prop 65. I invite conversations and opinions pro and con regarding Prop 65. Through the help of a group of Prop 65 Research Partners we have already made a start in developing Prop 65 strategies for fastener suppliers. There are plenty of resources and an extensive report with attachments, scenarios, strategies and solutions available. If you are struggling with Prop 65 please consider joining us. If you have it figured out especially consider joining us. There are several options on how to participate and there is a cost, but it's nothing like the cost of not being prepared for California's Proposition 65.

For more information contact Carmen Vertullo at Carver FACT Center. Tel: 619-440-5888 office, 619- 204 1543 cell, email carmenv@carverem.com or visit the website at www.carverfact.com. 

RICHARD HAGAN FASTENER COMPANY ACQUISITIONS COMPLETED DURING THE FIRST HALF OF 2018 from page 140



On February 28, 2018, **Consolidated Aerospace Manufacturing LLC** ("CAM") purchased **Moeller Mfg. & Supply Inc.** ("Moeller"). Founded in 1978 and located in Costa Mesa, California, Moeller is a manufacturer of washers spacers and shims for the commercial aerospace and defense markets. The company serves as a stocking manufacturer, maintaining more than 16,000 SKUs of in-stock inventory including NAS, AN, MS and BAC washers. Moeller supplies most of the premier aerospace OEMs including Boeing, Honeywell, Spirit AeroSystems, Lockheed Martin, Northrop Grumman and Bombardier. Established in 2012, CAM is the holding company for five companies which manufacture fasteners, fittings and hardware, predominantly for the aerospace market. The companies are: Aerofit LLC (fluid fittings); 3V Fasteners Company Inc. (externally-threaded fasteners); Bristol Industries Inc. (nuts & gang channels); QRP Inc. (quick release pins, latches and accessories); and Voss Industries Inc. (coupling devices, bulge-formed ducting components and fabricated subassemblies). CAM is a portfolio company of **Tinicum Inc.**, a New York City-based private equity firm with \$1.6 billion of committed capital under management.

Purchase price: not available



On March 1, 2018, **Reliance Steel & Aluminum Co.** ("Reliance") purchased **Dubose National Energy Services Inc.** ("Dubose Energy") and **Dubose National Energy Fasteners & Machined Parts Inc.** ("Dubose Fasteners"). Dubose Energy was founded in 1990 and is located in Clinton, North Carolina. Dubose Fasteners was founded in 2010 and is located in Cleveland, Ohio. Referred to collectively as "Dubose", the companies manufacture and distribute products for the nuclear power industry including utilities, component manufacturers and contractors. Dubose manufactures nuclear-grade bolts, nuts, studs and washers, along with fittings, forgings, fabrications and custom machined parts. The companies also stock nuclear-certified bar, plate and structural parts, including Unistrut® metal framing system products. The combined companies recorded net sales of \$36.3 million in the fiscal year ended June 30, 2017. Founded in 1939 and headquartered in Los Angeles, Reliance is the largest metals service center company in North America. Reliance provides value-added metals processing services and distributes more than 100,000 metal products to more than 125,000 customers. The company operates more than 300 locations in the United States and twelve other countries. Reliance shares are traded on the New York Stock Exchange (NYSE: RS).

Purchase price: not available



On March 1, 2018, **G.L. Huyett Company** purchased the **HANDI-CHEK** business unit of ITW Shakeproof Industrial Products ("ITW Shakeproof"). HANDI-CHEK was founded in the 1970's and is one of the best known packaged fastener brands. The brand originally catered to farm and ranch stores in the upper Midwest. The business was eventually acquired by ITW Shakeproof and is marketed to the industrial supply sector. HANDI-CHEK kits are now sold by many of the fastener industry's leading catalog distributors. Founded in 1906 and located in Minneapolis, Kansas, G.L. Huyett is a master distributor specializing in non-threaded fasteners and grease fittings. The company supplies the industrial distributor market and its product range includes bearing lock nuts, Belleville washers, crescent rings, housing rings, snap rings, cotter pins and many more. Following the transaction closing, G.L. Huyett plans to convert its existing packaged goods lines over to the HANDI-CHEK brand. Furthermore, the operations of HANDI-CHEK were relocated to G.L. Huyett's 65,000 square foot headquarters.

Purchase price: not available



On March 2, 2018, **EDSCO Fasteners Inc.** ("EDSCO") purchased **Tower Support Services Inc.** ("TSS"). Founded in 2011 and located in McKenzie, Tennessee, TSS is a manufacturer and distributor of foundation anchoring systems for critical infrastructure installations including power transmission, cellular, wind energy and lighting towers. TSS operates the only fully integrated anchor bolt facility in the United States and is located near a rebar mill to minimize freight costs. Founded in 1985 and headquartered in Denton, Texas, EDSCO is a manufacturer of foundation anchor bolts and engineered foundation cages for critical infrastructure applications. The company's systems are predominantly embedded in a concrete foundation upon which a large steel structure such as a power transmission pole, pedestrian bridge or a large sign structure pole can be securely attached. In addition to its flagship operation in Denton, EDSCO maintains fabrication and warehouse facilities in Harrisburg, North Carolina and Spanish Fork, Utah. EDSCO is a portfolio company of **LMF Capital LLC**, a Nashville, Tennessee-based private equity firm with \$100 million of committed capital under management.

Purchase price: not available

The Industry Leader in Security Screws



For Over 40 years

Screws Proudly Made in the

USA



Tamper-Proof
Screws, Inc
Paramount, Ca

Enter and Edit User Security

Once you have established the Security Levels, you are now ready to setup the overall security for each User. This is done through Enter & Edit User Permissions in the Security Menu.

You can enter or select a user name. The first question is Security Level; select the appropriate security level for the user you have selected. There are up to eight screens with flags that are based on menu and higher security type options. Access to the System Administrator System should be limited, since users that have access to the System Administrator also have access to the Security System.

There are flags that can be used prevent access to items on the first level of the menu tree. For example, this user cannot access anything within the "General Ledger System" If this user tries to open the "General Ledger System" they will get an "Access Denied" message.

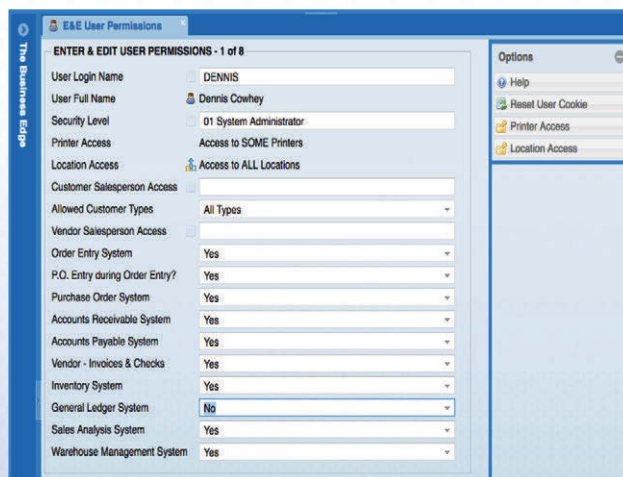
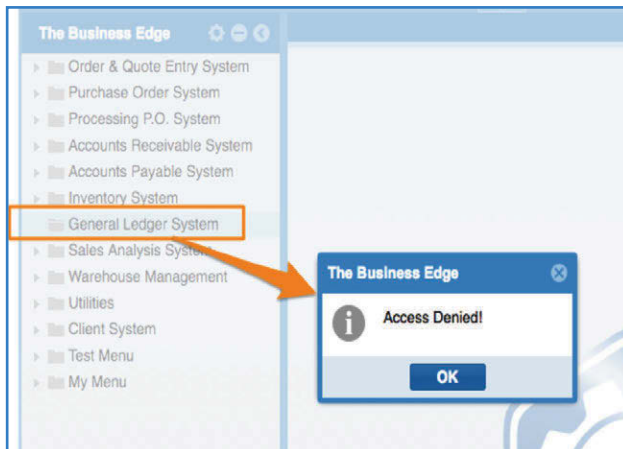

Printer Access

If you would like to limit the use of certain printers to specific employees, you can do so with the Printer Access button. This is an efficient way to isolate certain Printers for specific uses. It will also prevent someone accidentally printing to the wrong printer.

Customer Salesperson Access

This can be left blank to allow access to all of the customers. If a salesperson is selected the user will only be able to see customers that are assigned to that salesperson. The same is true for Vendor Salesperson Access. The Customer Types flag is used when using the CRM Actions module.

In addition to limiting the parts of the system the user can use, the security system can also limit whether or not they can change certain information, e.g. Product Numbers, Customer Numbers, etc., further limitations are very specific, e.g. can change Quote to Order or not. There are other limitations that are too numerous to mention here, but you get the idea.

Management Has Control

Management has complete control of what people can see or do. They can easily change the security parameters as the employee grows with the company and becomes a trusted employee.

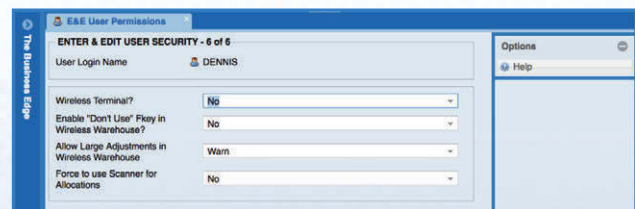
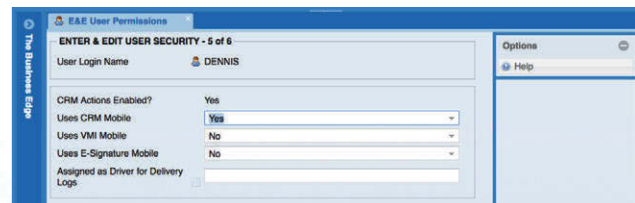

When the user is set to "Limit to My Menu Only" the only item in the menu tree will be "My Menu" and the only toolbar menus that give access to menu items will be My Tasks, Auto Launch, and My History.

distributornews

In the last several months **The DPA Buying Group** is pleased to welcome fifteen new distributor members to its industrial & contractor supply division:

AFC Industries

- Fairfield, OH
headquarters

Altra Rental & Supply, Inc.

- Ontario, NY

Blackfoot Industrial Supply Centre, Inc.

- Calgary, AB

Bradley Tools & Fasteners

- Johnston, IA

Cinega Construction Supply, Inc.

- Ponte Vedra Beach, FL

Davis Industrial Packaging and Supply

- Denver, CO

DES LLC

- Beloit, WI

DNA Tools and Supplies

- Burnaby, BC

Gov Supplies

- Lakewood, NJ

Maintenance Supply & Fastener Co., Inc.

- Memphis, TN

Northwest Industrial Supply LLC

- Bryan, OH

Perkins Hardware Enterprises, Inc.

- Brookhaven, MS

Scorpion Pump and Industrial LLC

- Tecumseh, OK

Troop Industrial (Kelkar LLC)

- Port Neches, TX

headquarters

U-Turn Rentals

- Wichita, KS

AEH All Electronics Hardware

"Whatever It Takes"



www.aehonline.com 1-800-778-7234



The DPA Buying Group is a North American buying and networking organization comprised

of more than 875 distributors and 230 preferred suppliers in the Industrial, Janitorial, Safety, Public Safety, Packaging and Restoration product industries.

For more information about The DPA Buying Group, contact them Toll-free at 1-800-652-7826, Tel: 513-794-3343, Fax: 513-794-3342 or visit them online at www.DPAIndustrial.com.

LORRI HUNT THE ISO 9001 TRANSITION IS OVER, NOW WHAT? from page 144

[3] Determine the effectiveness of actions taken. This is a requirement in management review. Include information in the documented information either through a column in a spreadsheet or description that provides this analysis.

If an organization takes these simple steps, it will be easier to manage this requirement on an ongoing basis.

The final action that the organization needs to ensure is in place to sustain its ISO 9001:2015 implementation is the accountability of top management (clauses 5.1.1 and 5.3). The ISO 9001:2015 revision brought with it a need for a higher level of engagement of management by removing the focus of one person having responsibility for the management system through the assignment of the management representative role and transitioning to requirements that focused on an organization's top management having accountability for the quality management system.

This accountability can be achieved by ensuring that management is involved with those aspects of ISO 9001

that are directly related to the strategic direction of the organization, including the external and internal issues, risks and opportunities, and management review.

To avoid the first-year surveillance blues, organizations should review what they put in place now and not wait until just prior to their next surveillance audit. This review could include the analysis of whether the process that was used for achieving the transition is repeatable. If so, the organization is good to go and can review these new requirements at the time of the next planned review. If not, the organization needs to determine the process going forward to demonstrate that important repeatable aspect of ISO 9001 implementation.

The most important thing to remember is this is what an organization is typically doing already to manage its process. It doesn't require you to do anything new if you have something in place. Organizations just need to create a repeatable framework to make it easy to explain these processes. 

LORRI HUNT

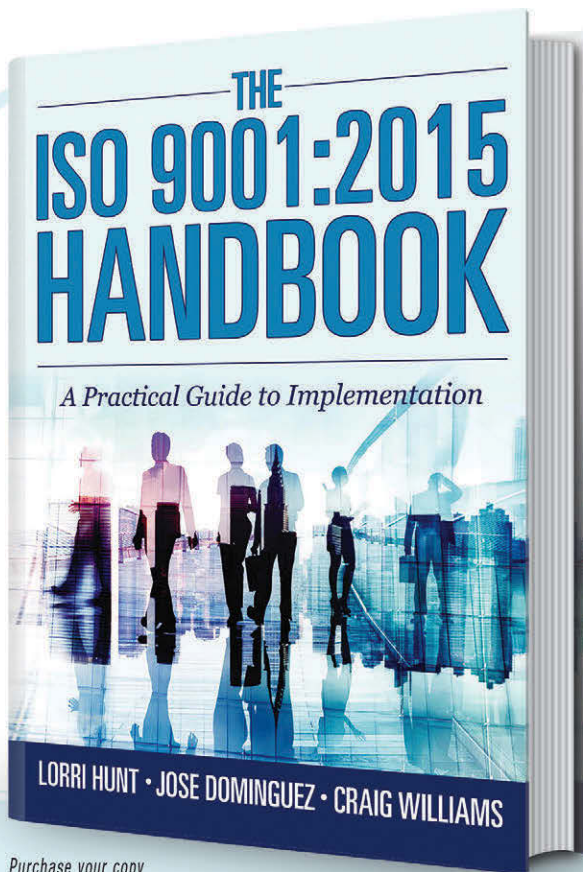

Purchase your copy
now at www.patonprofessional.com

LORRI HUNT & ASSOCIATES INC.

Professional Coaching To Help Your
Organization Reach Its Potential

- * ISO 9001 IMPLEMENTATION
- * GAP ANALYSIS
- * INTERNAL AUDITING
- * PROCEDURE WRITING
- * TRAINING
- * MENTORING / CONSULTING

Kansas City, MO | TEL 816-474-3996
EMAIL lorri.hunt@gmail.com | WEB www.lorrihunt.com

Looking for Flange Bolts & Flange Nuts?

We've got you covered.

Stocking Products



FLANGE SCREWS

Grades 5 & 8
Grades 5 & 8 Serrated
Grade 5 Large Serrated
18-8 Stainless Steel Serrated
Hex Flange Head Lag Screws
12 Point Head Alloy - **NEW!**



FLANGE NUTS

Grades 5 & 8
Grades 5 & 8 Serrated
Case Hardened Serrated
18-8 Stainless Steel Serrated
Case Hardened Large Serrated
Grade G All Metal Top Lock Nuts
Grade F Nylon Insert Lock Nuts



METRIC FLANGE PRODUCTS

Class 8.8 & 10.9 DIN Screws
Class 8.8 Serrated DIN Screws
Class 10.9 JIS Small Head Screws
Class 10 DIN Nuts
Class 10 DIN Flange Lock Nuts
Class 8 DIN Serrated Nuts
Class 10 JIS Nuts
Class 10 JIS Serrated Nuts



PLOW BOLTS

#3 Dome Head Grade 8

CARRIAGE BOLTS

Grade 8 Full Thread - Shaker Screen



WASHERS

USS & SAE "NT" Hardened Flat
USS & SAE "NT2" Thick Hard Flat
SAE "NTX" Extra Thick Hard Flat
1/8" Extra Thick Fender



Services

Package & Bulk Quantities

NEW! Easy Online Quoting & Ordering

Custom Packaging & Kitting

Fastener Refinishing Capabilities

Same/Next Day Shipping

Stock & Release Programs

**EASY ONLINE ORDERING
NOW AVAILABLE!**

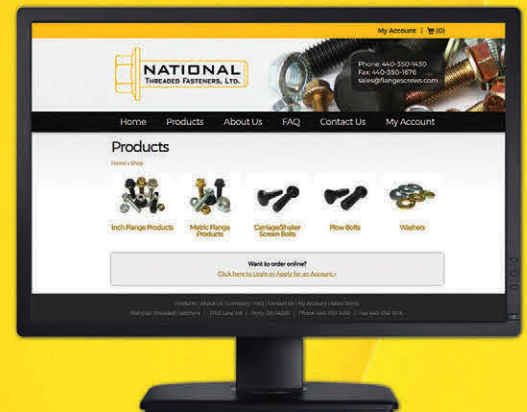

ISO 9000:2015 REGISTERED



Phone: 440.350.1430 | Fax: 440.350.1676 | Email: sales@flangescrews.com

Flood precautions start before the warnings

- ▣ Shut down operations and remove portable critical equipment (computers, hard drive back ups, etc.) to a safer location.
- ▣ Drain or remove any flammable materials, including lubricants, solvents and paint.
- ▣ Move as much inventory as possible to upper storage locations, leaving only expendables and easily replaced stock at floor level.
- ▣ Anchor any large objects (desks, tables, etc.) that could become floating battering rams.
- ▣ Place sandbags, flood shields and other temporary dikes in position.
- ▣ Assemble flood control supplies, water, first aid, pumps, generators and other items to support any personnel who may remain in the building.
- ▣ Establish a temporary safe storage area on high ground for clean up and salvage supplies.
- ▣ Turn off gas, electricity and other utilities.
- ▣ Consider counter flooding the facility with clean water.
- ▣ Be prepared to evacuate and establish a safe route out of the affected area.
- ▣ Provide a means of escape for any personnel left in the building.

Earthquakes, everywhere in the US is a "seismic area"

- ▣ Inspect the building periodically to verify structural integrity and maintain the facility in good repair at all times.
- ▣ Survey the interior for hazards such as loose and unstable items, unsecured bookcases and shelving.
- ▣ Replace old style pallet racks and shelving with new seismic rated storage equipment.
- ▣ Assemble any vital supplies in a relatively earthquake proof area.
- ▣ Designate a "seismic safe" area or exit route.
- ▣ During an after an earthquake:
 - Don't panic.
 - Evacuate and assemble in a safe, prearranged area.
 - Do a head count.
 - Shut off utilities.
 - Fight any fires, if possible.
 - Coordinate with Civil Defense and emergency

personnel.

- Clear paths for emergency vehicles.
- Assess the damage - stay out of precarious structures.
- Be constantly aware of hazards due to downed wired, gas leaks, etc.
- There will be aftershocks, take risks accordingly.

Hurricanes and high winds are predicable

- ▣ Shut down the operations and turn off utilities.
- ▣ Inspect all outdoor areas for loose objects, such as pallets and other storage.
- ▣ Secure, move or dismantle signs, loose downspouts, awnings and outdoor structures.
- ▣ Clean sewers, drains and downspouts to reduce flooding.
- ▣ Brace and/or shore up any structures and doors as required.
- ▣ Close and board up all windows.
- ▣ Remove portable equipment and records to a safer location.
- ▣ Separate primary and backup records at multiple locations.
- ▣ Insure that any personnel who will remain have adequate supplies of food, water, blankets, first aid, flashlights, communications, etc.
- ▣ Take shelter and don't leave the shelter until after the storm passes, not just the eye of the storm.
- ▣ Beware of downed power lines, broken gas mains and other hazards.

Tornados, when every moment counts

- ▣ Open windows and doors on the lee side of the building.
- ▣ Turn off utilities only if this is on the way to shelter or in a sheltered area.
- ▣ Grab only what can be quickly carried, especially cell phones, lap tops or portable communication devices.
- ▣ Evacuate to a predetermined safe interior area.
- ▣ Stay in the shelter until an all clear is sounded.
- ▣ Initiate rescue after the storm has passed.
- ▣ Put out fires and deal with flooding following established procedures.
- ▣ Beware of downed power lines, broken gas mains and other hazards.

MID-WEST FASTENER ASSOCIATION TABLE TOP SHOW ELK GROVE VILLAGE, IL - JUNE 4, 2018



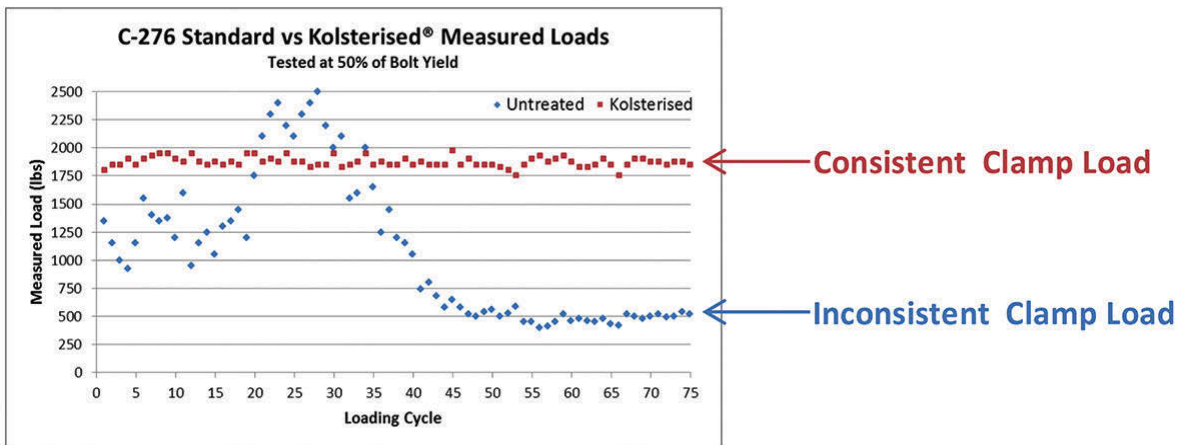

FIGURE 2: THIS PLOT COMPARES THE MEASURED CLAMP LOAD OVER 75 LOADING CYCLES WHEN TORQUED TO 50% OF BOLT YIELD STRENGTH FOR C-276 UNTREATED AND TREATED FASTENERS.

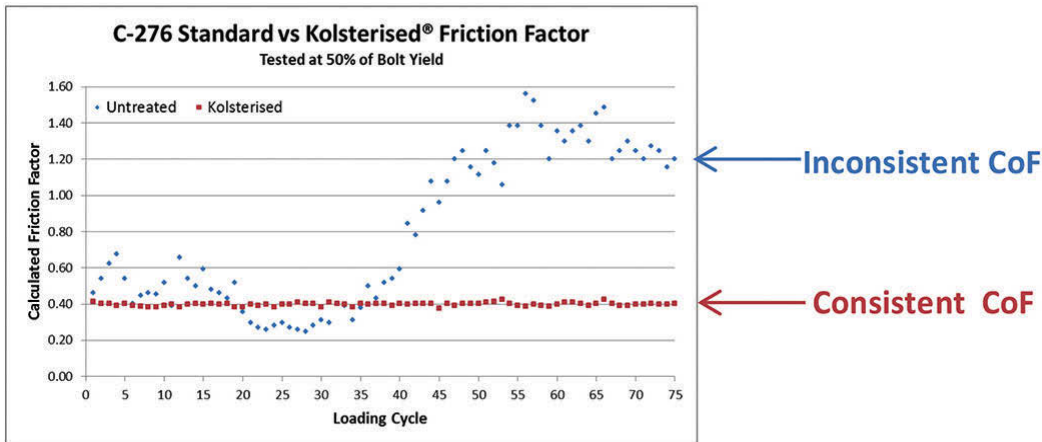

FIGURE 3: THIS PLOT COMPARES THE FRICTION FACTOR OVER 75 LOADING CYCLES WHEN TORQUED TO 50% OF BOLT YIELD STRENGTH FOR C-276 UNTREATED AND TREATED FASTENERS.

While a completely cold welded joint is the worst case scenario, we should also consider the surface condition leading up to this point. This was investigated by K. Clark[1] on various types of fasteners, including B8M Class 1, B8M Class 2, and Hastelloy® C-276 fasteners. It was observed for the untreated conditions that as surface degradation occurs, the CoF increases and, if the same installation torque is being used, the clamp load of the joint can be decreased significantly. Figure 2 shows fluctuation of clamp load over subsequent loading cycles, while Figure 3 shows the translation to CoF over the same loading cycles for Hastelloy® C-276 fasteners. As shown, the behavior of the treated fastener remains constant as the treatment prevents galling and adhesive wear from occurring.

Conclusion

In conclusion, it is a well-known fact that while the fastener may fail, it is typically not the fastener to be identified as the problem but more likely the root cause is due to improper fastener selection or improper installation. Kolsterising® can be a great option to explore when looking to achieve a more consistent clamp load in a joint where stainless steel fasteners are being used. In addition, because the safety factor can be truncated, more than 40% of the fastener's potential can be utilized. This can also be an opportunity to use fewer fasteners or potentially move to smaller fasteners. Both of these can be opportunities for fastener cost savings as well as less drilling/tapping operations in the manufacturing process of the mating components in the joint.

LUBRICATION COMPONENTS

Your grease fitting source!

ISO 9001
Certified Products

SAE J-534/15 &
DIN 71412

JIT Inventory
Program

Same Day
Shipping

Grease Fittings

Relief Fittings

Stainless Steel
Grease Fittings

Grease Fitting
Couplers

ROHS compliant



Lubrication Components, 8572 NW 56th Street Doral, FL 33166
Fax: 305-418-9511 / Phone: 305-418-9510 / Mobile: 312-560-2975
E-mail: sales@lubricom.com / Web site: www.lubricom.com

SRC Special Rivets Corp.

Now has a company representative in the U.S.

Headquartered in Taiwan with two factories in China and a monthly production capacity of 500 million blind rivets. SRC offers break stem blind rivets of various materials and some high strength STRUCTURAL blind rivets. Because of our high production capacity we offer good prices and service. SRC has been supplying blind rivets to some of the largest companies in the blind rivet market.

SRC now has a company representative in the U.S. to serve our customers. Tony Di Maio is well known in the blind rivet industry and he will assist you in every way he can. We appreciate the opportunity to quote your blind rivet needs. Contact Tony for catalogs.

SRC offers the following:

- Quality ISO Approved and Manufactures to IFI Specifications
- Competitive Pricing • Fast Delivery
- Fast, Accurate Communication • Technical Assistance by Tony

Contact: **Tony Di Maio**

6 Hermon Ave. • Haverhill, MA 01832

Phone: 978-521-0277 • Email: tdimai@verizon.net



ISSCO, INC.

405 SE Bailey Road, Lee's Summit, MO 64081

TEL 816-525-8889 FAX 816-525-8790 EMAIL sales@isscoinc.com WEB www.isscoinc.com

EMPLOYEE RECOGNIZED AS TOP 30 IN 30 PARTNER FOR WAREHOUSE1

ISSCO, INC.'s salesperson, Jennifer George, was recognized as a Top 30 Partner in Warehouse1's first 30 years of business. This honor is awarded to Jennifer for her continual efforts to provide exceptional customer service.

The CEO of Warehouse1, Mary Lou Jacoby, speaks about the selection process for the 30 in 30 Partner Awards.

"We spent several weeks pouring over our spreadsheets that list and rank past customers that have been loyal for the last 30 years. Our goal was to recognize and thank the people and companies that have been our customers for decades and tell them how much we appreciate their friendship and

loyalty. And what an honor it has been to share their success and growth and how proud we were to be a small part of it.

Without the best product, delivered on time, at the right cost, with the best advisors on application and use, and the friendship and ingenuity of our suppliers, we would be nothing. We decided that saying thank you to them was as or more important than thanking our customers.

The suppliers are the ongoing asset we should reward. And so the 30 in 30 Partner award was created! We need you every day for the next 30 years and we are proud to share in your success. It was time to let you know how important you are to our success."

The Warehouse1 operations manager, Dennis Delantonas elaborates specifically on Jennifer's work ethic and customer service.

"We have been working with ISSCO for over 10 years to supply our customers with the hardware they need. When we have emergency orders Jennifer and ISSCO have always provided what we need or determined an alternate to make sure the hardware is shipped on time.

Working with Jennifer and the support staff at ISSCO exceeds my expectations of customer service."

ISSCO, INC president, Jake Davis, recognizes Jennifer's hard work and exceptional customer service focus. "From our beginning in 1974, my father's main focus has always been on customer service and I am thrilled to see Jennifer

recognized by one of her customers. She continually exceeds the expectations of her customer base and has full support from the entire team here at ISSCO, INC. Job well-done Jennifer and keep up the great work."

Congratulations Jennifer on this award, and for your continual positive attitude and exceptional work ethic you bring to ISSCO daily!

ISSCO, Inc. was founded in 1974 by the current CEO Joe L. Davis Jr. in the basement of his home. The company was established with one goal in mind: to efficiently and successfully service our customers. After many years of perfecting the distribution of quality fasteners, our product lines and inventory levels continue to reflect our commitment to customers throughout the Midwest. Over 40 years later, the ISSCO team proudly continues to build successful customer relationships with the same goal top of mind. 





7500 NEW HORIZONS BLVD.
 AMITYVILLE, NY 11701
 TEL: 800-645-1234
 TEL: 631-225-6400
 FAX: 631-225-6499
 EMAIL: NOVAFSTNER@AOL.COM
 WEB: WWW.NOVA-ANCHOR.COM

**With a shrinking global sourcing market.....
 Here we GROW again !**

ANCHORS • SCREWS • NUTS • WASHERS • RIVETS • PINS INSERTS • RODS

- Acoustical Lags
- Augers (Zinc/Plastic)
- Chair Seating Anchors/Studs
- Chemical Anchors/Studs
- Coupling Nuts
- Drive Pins
- Drop Ins
- Hammer Drives
- Hollow Wall Anchors
- Lag Shields
- Lead Wood Screw Anchors
- Machine Screw Anchors
- Nylon Nail-Ins



- Plastic & Vinyl Plugs
- Pull Toggles
- Self Drills
- Set Bolt Anchors
- Single/Double Expansion Anchors
- Sleeve Anchors
- Split Drives
- Toggle Wings/Bolts
- Toggles - Plastic
- Wall Hooks
- Wedge Anchors
- Threaded Rod



**• COMPLETE STOCKING
 INVENTORY OF ALL
 COMMERCIAL FASTENERS
 • MILL QUOTES
 WELCOME**



ANCHORS ANCHORS ANCHORS

Conforming to all government specifications....AN, MS, NAS and commercial
 J.I.T. Delivery
 Direct Importing
 In-House and On Line shopping
 Certs on Request
 Full Lot Traceability

Standard and Metric Specials
 All materials, grades & finishes
 Special fabrication
 Bar Coding

PACK IT



BULK IT

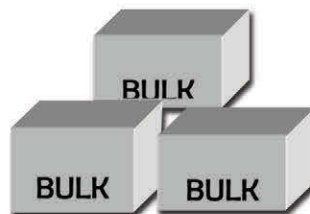

or CONTAINER IT



**REGIONAL WAREHOUSES IN NY, SC AND GEORGIA
 GUARANTEED CUSTOMER SATISFACTION**



Blind Trust

As an OEM, you probably have a list of requirements for your suppliers to guarantee, from ISO certifications to Product Part Approval Processes (PPAPs), to Certificates of Conformance or Origin. Given how widespread various frauds are in the manufacturing industry, we've seen countless examples firsthand of foreign and domestic companies that have forged or faked various documentations, in both direct manufacturers and suppliers. Do you rely on your supplier to self-report on these types of certifications? Is there a reputable third-party auditing or certification agency that is involved? If these are questions that you are asking your suppliers, then you are already one step ahead in awareness of what types of documentation or certification has a higher risk of fraud.

Outside of documentation malfeasance, many OEMs often fall victim to blindly trusting from where their suppliers source their materials. Do you know where and how your suppliers are acquiring their raw materials or parts? How can you guarantee that?

Often times, specifications are crucially important and a supplier must have exacting demands on themselves in order to ensure that a material has been treated properly. Even better if all of this is done in-house, as there is a higher chance that the quality controls are even stronger. Once you've determined the areas that you may

blindly trust your suppliers, the next step is actually doing something about your fraud risks.

Complacency

Even with just a handful (or in a majority of cases, several thousand handfuls) of suppliers, it can easily be overwhelming to maintain a discerning eye to your suppliers; however, this is precisely what keeps fraudulent suppliers in business. They are relying on you to keep your guard down, ask fewer questions, and ultimately give up or grow complacent. This is where vigilance and keeping your eyes on employee, company, and consumer health and safety is crucially important.

When was the last time you asked your supplier for an updated compliance certificate? Have you done your research on the third-party certifying that they are using? What about looking into conducting a facility tour or manufacturing floor tour or audit? While an in-person audit may not all be practical, especially for many smaller operations, these are the types of questions that need to be asked, yet rarely are. A supplier's response to these kinds of questions can indicate deeper concerns. If there is friction with these simple and initial questions, it can often be an indication of a deeper, more serious question below the surface. I've heard from many purchasers that have been refused a facility tour, and then ask no more questions, for fear of being more trouble. This is exactly the moment that you need to start asking more questions.

What To Look For In A Quality Supplier

We will now cover the five key factors when looking for or reviewing existing supplier that you can trust and rely on for your production needs. These five factors are: Vertical Integration, Product Traceability and Accountability, Comprehensive Technical Support and Customer Service, an Open Door policy, and a Wide Range of Product Offerings. Additionally, on the following page, we've included a convenient checklist that you can print out or share with your colleagues.

Become a
**Distributor for
Thread Repair**

Sell to:

- *Oil fields *Mining
- *Aircraft *Automotive
- *Electronics *Marine



Giant sizes in stock

CHRISLYNN
Threaded Inserts
PRECISION



Rock Solid
K-Type



Precision Helical Wire



E-Z Fix/E-Z Lok

****NO MINIMUMS****

****SAME DAY SHIPPING****

Professional Thread Repair

***MEETS MIL-SPECS *DFAR COMPLIANT**
GIANT METRIC up to M64 & GIANT 8-PITCH up to 5" DIA
EXTRA FAST DELIVERIES ON SPECIALS

WWW.CHRISLYNNINSERTS.COM

EMAIL: sales@chrislynninserts.com

PHONE: 800-926-1495

FAX: 888-526-4566

CHRISLYNN
Threaded Inserts
PRECISION

Tel: 1-800-926-1495

Fax: 1-888-526-4566

Email: info@chrislynninserts.com

www.chrislynninserts.com

**BE A
HERO -
SAVE THE
DAY**

Be the one to provide a quick solution to the time-consuming problem of tearing down a piece of equipment just to repair a stripped out threaded hole.

Being a Chrislynn Insert distributor could save your customer the time it takes to tear down and re-assemble, just to repair a worn out thread.

Heroes are available late hours and weekends, and so are we here at Chrislynn.

Heroes have the right tools for every job, and so do we at Chrislynn.

[1] Special sizes

[2] Special thread pitches

[3] Special materials

[4] Special coatings

[5] All popular sizes

Sell a product that could gain you new customers.

**Join our winning team and be
a hero to your customers. ⚙**

BRICO INDUSTRIES BRIGHT NAME IN MIDWEST MANUFACTURING *from page 188*

Document Management

Tom continued, "We also utilize TBE's document connection, for scanning, storing and attaching documents in the system. We have both internal manufacturing prints, as well as customer prints on every item. We also do customer proposal prints, for clarifying the quotes when things are missing and not as clear as needed on quotes. Having all of those items available from multiple screens, allows everyone to be on the same page throughout the company. TBE allows receipts, packing lists, and miscellaneous paperwork to be stored in the system. Having raw material, plating, and heat treat certs available in the system saves time and reduces mistakes. Having a central location for all items, and always at a click of a button keeps the system live all the time."

The Right Choice

Tom is enthusiastic about The Business Edge.™ He said, "Our decision to go with Computer insights as

our vendor, turned out to be one of the best things we have done. Brico was growing at a nice comfortable rate, with success in many areas. We were really hesitant to switch, thinking it was going to be a lot of work, confusion and problems. What really happened was it was easier, smoother and allowed us to grow at a faster rate and it has made Brico stronger. We ended up with a partner in Computer Insights, not just another vendor."

More Information

Brico Industries, Inc. can be reached at 777 North Larch Street, Elmhurst, IL 60126. Contact Tom Tumbarello, President by telephone at 630-833-0700, eMail: tomt@bricoind.com or visit them online at www.bricoind.com.

Computer Insights, Inc. can be reached at 108 3rd Street, Unit 4, Bloomingdale, IL 60108. Contact Denny Cowhey by telephone at 1-800-539-1233, eMail sales@ci-inc.com or visit them online at www.ci-inc.com. 

BRICO INDUSTRIES

NFDA KELLY COLE ELECTED NFDA PRESIDENT FOR 2018-2019 *from page 202*

Breakfast Sponsors

- ▣ Brighton-Best International (NFDA Platinum Partner)
- ▣ AVK Industrial Products
- ▣ Mack Brooks Exhibitions
- ▣ R.L. English Co.
- ▣ Sems & Specials
- ▣ Taiwan Fastener Trading Association
- ▣ TRAMEC Hill Fastener

Lunch Sponsors

- ▣ Rotor Clip Company (NFDA Silver Partner)
- ▣ All American Systems
- ▣ AutoCraft USA
- ▣ AVK Industrial Products
- ▣ Brikksen
- ▣ Distribution One
- ▣ EFC International
- ▣ Sems & Specials
- ▣ Taiwan Fastener Trading Association

General Sponsors

- ▣ AZ Lifting Hardware
- ▣ Computer Insights
- ▣ IFE Americas
- ▣ Midland Metal Mfg.

- ▣ Parker Fasteners
- ▣ R&D Fasteners
- ▣ Spirol Distribution
- ▣ Spring Bolt & Nut Mfg.

Upcoming NFDA Events

September 10-11, 2018

Leadership Academy
Co-Sponsored by Young Fastener Professionals
Holiday Inn, La Mirada, California

March 14-16, 2019

Joint Meeting with NFDA, Mid-West Fastener Association, and Pacific-West Fastener Association
Omni Hotel, San Diego, California

June 10-11, 2019

Annual Meeting
Co-Sponsored by the North Coast Fastener Association
Hilton Netherland Plaza Hotel, Cincinnati, Ohio

For more information about NFDA and its activities, visit www.nfda-fastener.org. 

distributornews

LeJeune Bolt Company is pleased to announce an exclusive partnership with Boulons Plus to become the authorized Canadian distributor of the TNA® Torque + Angle Fastening System. Boulons Plus and subsidiary Precision Bolt will begin marketing and selling LeJeune's patented TNA® Fastening System into the Canadian steel construction market.

With locations in Montreal, Edmonton, and Toronto Boulons Plus is ideally positioned to introduce this revolutionary bolting technology to the Canadian steel construction industry. Jeff Greene, Vice President at LeJeune Bolt says, "After our successful launch of this technology in the United States we set our sites on finding a Canadian partner with the proper infrastructure and technical knowledge to roll out the product line in the Canadian marketplace. After meeting Maxime Cousineau, President/CEO of Boulons Plus, and his expert staff it was clear that this was the right fit. I have a high level of confidence that Boulons Plus is ready for this challenge and will do an excellent job educating the Canadian steel market about this incredible technology."

The TNA® Fastening System is the revolutionary bolting system that uses the exclusive 144ksi ASTM F3148 single-sided spline drive bolt and the dual function Torque and Angle TAE Series installation tools to deliver economical, accurate and repeatable bolting for structural steel construction. Visit www.tightenright.com for info.

LeJeune Bolt Company, headquartered in Burnsville, MN, with a West Coast office in Chino, CA, is an international distributor of structural grade fastening systems, installation tools, and related fasteners for the commercial steel and concrete construction, bridge building, and transportation markets. Our products include; TNA® Torque + Angle Fastening System, Structural Bolts, Anchor Bolts and Threaded Rod, Weld Studs and Equipment, Industrial/OEM Fasteners, and Installation Tools and Equipment.

For more information contact LeJeune Bolt Company at 3500 West Highway 13 Burnsville, MN 55337. Tel: 1-800.872.2658, Email sales@lejeunebolt.com or visit them online at www.lejeunebolt.com.

FASTENER NEWS DESK



YOUR 'FAST' CONNECTION TO:

FASTENERS	WORKFORCE/SKILLS GAP
MANUFACTURING	EVENTS
3D PRINTING	REPORTS
AEROSPACE	MAGAZINES

FASTENERNEWSDESK.COM

 @FastenerNews

 Fastener News

 Fastener News

#Fasteners



Search it.

Source it.

No charge.

fastenersclearinghouse.com

FCH is your go to resource for hard to locate or fill-in items.
Over 1 million listings, thousands of users!



RICHARD HAGAN FASTENER COMPANY ACQUISITIONS COMPLETED DURING THE FIRST HALF OF 2018 from page 206



On March 2, 2018, **Red Hawk Fasteners LLC** (“Red Hawk”) purchased the composite fasteners business assets (the “**Composite Fastener Division**”) of **Kyocera Senco Industrial Tools Inc.** (“Kyocera Senco”). The Composite Fastener Division develops and distributes composite staples and nails for the timber processing, woodworking, millwork, composite fabricating and wood boat building industries. Composite fasteners are made from a blend of fiberglass and resin that can be sanded, shaped and cut without damage to saw blades, sanding belts, router bits and mold knives. Composite fasteners are metal-free so rust and corrosion are eliminated and their mechanical properties can be engineered for specific application requirements. Founded in 2016 and located in Greensboro, North Carolina, Red Hawk develops and distributes composite staples, nails and brads for timber processing, woodworking, millwork and a range of other applications. Red Hawk sells composite fasteners, along with a range of staplers and nailers, through a nationwide network of authorized distributors.

Purchase price: not available



On March 23, 2018, **Trinity Logistics Corporation** (“Trinity”) purchased **Agrisolutions Corporation** (“Agrisolutions”). Founded in 2003 and headquartered in Davenport, Iowa, Trinity is a distributor of fasteners and Class C components specializing in providing customers with advanced supply chain management solutions. Trinity offers vendor managed inventory (VMI) programs, custom packaging, kitting and light assembly services to OEM customers primarily in the farm equipment and general industrial sectors. The company operates nine distribution centers in Wisconsin (2), Iowa (2), North Dakota, Minnesota, Illinois, Kansas and Georgia, with a total of more than 350,000 square feet of warehouse space. Established in 2014 and headquartered in Hamilton, Ontario, Agrisolutions is a global developer and manufacturer of wearable components and accessories for farm equipment manufacturers and agricultural aftermarket suppliers. Through its Bellota, Ingersoll and Rozalma brands, the company produces a broad range of product solutions for tillage, seeding, planting and fertilizing. Agrisolutions operates six manufacturing plants in Spain (2), Canada, the United States, Brazil and India. The company markets its products worldwide including in China, Russia and the Ukraine.

Purchase price: not available



On April 2, 2018, **Endries International Inc.** (“Endries”) purchased **Branam Fastener Systems Inc.** (“Branam”). Founded in 1986 and located in Cleveland, Ohio, Branam is a value-added distributor of fasteners and Class C parts to the OEM and distribution markets. The company provides its general industrial customers with advanced supply chain management solutions. Branam has particular expertise in the stud welding product category and these products are sold to end-users and other distributors. Founded in 1970 and headquartered in Brillion, Wisconsin, Endries is a distributor of fasteners and Class C parts, specializing in providing customers with advanced supply chain management solutions. The company provides its customers with robust bin-stocking programs including automatic electronic ordering based on RFID technology. In addition to the Wisconsin flagship location, Endries operates eight distribution centers in the United States (6), Canada and Mexico. The company employs approximately 700 people and generates annual net sales of around \$250 million. Endries is a portfolio company of **Nautic Partners LLC**, a Providence, Rhode Island-based private equity firm with \$3.3 billion of committed capital under management.

Purchase price: not available



On April 2, 2018, **Stanley Black & Decker Inc.** (“Stanley”) purchased **Nelson Fastener Systems** (“Nelson”). Founded in 1939 and headquartered in Elyria, Ohio, Nelson is a diversified manufacturer of fasteners for the automotive, truck, power generation, heavy equipment, aerospace and general industrial markets. Formerly known as Doncasters Fastener Systems, Nelson is comprised of seven business units: i) Nelson Stud Welding Inc.; ii) The Ferry Cap & Set Screw Company; iii) Specialty Bar Products Company; iv) Automatic Screw Machine Products Co. Inc. v) TOG Manufacturing Co. Inc.; vi) Erie Bolt Corporation; and vii) Bulldog Barrels LLC. The acquisition does not include Nelson’s automotive stud welding business. Founded in 1843 and headquartered in New Britain, Connecticut, Stanley is a global provider of hand tools, power tools, engineered fastening systems, mechanical access solutions and commercial electronic security & monitoring systems. In calendar 2017, Stanley recorded net sales of \$13.0 billion and employed more than 57,000 people. Nelson will be integrated into the Stanley Engineered Fastening division. The seller of Nelson was **Doncasters Group Limited**, which manufactures and markets engineered components for the aerospace, industrial gas turbine, specialist automotive, petrochemical and general industrial markets.

Purchase price: \$430.4 million

Buckley QC Fasteners

Conversion Specialists of Threaded Fasteners

BRASS TIP • NYLON TIP • NYLON PELLET INSERT



- Inch and Metric •
- Standards and Specials •
- Miniatures •
- Prototype and High Volume •
- Complete and Process Only •

Free Samples Available
for Your Evaluation

YOU Decide It...
WE Can Provide It

Buy Quality With Confidence

3874 California Road, Orchard Park, NY 14127
Phone 800.344.3874 • 716.662.1490 • Fax 716.662.0669

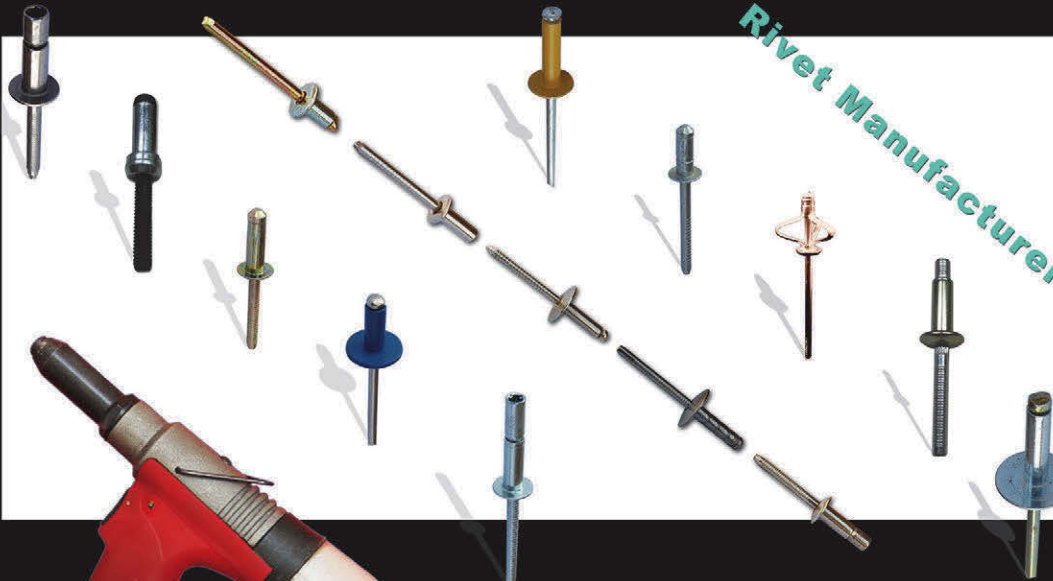

Rivet Manufacturer In China



Shanghai Fast-Fix Rivet Corp.

NO. 1151, Lian Xi Road, Shanghai, P.R. China 201204
T: 0086-21-58912860 (sales) F: 0086-21-58912793 (sales)
E-mail: sales@rivet-china.com
URL: www.fastfix-rivet.com

Factory: JiangSu Fast-Fix Fastener Co., Ltd.
Jing Jiang Fast-Fix Rivet Manufacturing Co., Ltd.

www.fastfix-rivet.com

High Quality in China

NATIONAL FASTENER DISTRIBUTORS ASSOCIATION

3020 Old Ranch Parkway #300, Seal Beach CA 90740

TEL 562-799-5509 FAX 562-684-0695 EMAIL nfda@nfda-fasteners.org WEB www.nfda-fasteners.org

JIM RUETZ AWARDED NFDA'S 2018 FASTENER PROFESSIONAL OF THE YEAR AWARD by Vickie Lester



The NFDA is pleased to announce the 2018 recipient of its Fastener Professional of the Year award is Jim Ruetz of AIS (Franksville, Wisconsin).

The Fastener Professional of the Year award was created by NFDA to honor individuals and companies

that make a substantial positive impact on people's lives. The inaugural award in 2017 was presented to Robbie Gilchrist of Capital Marketing (High Point, North Carolina).

The award recognizes:

- An individual from a fastener distributor or supplier company who makes exceptional contributions to their company and to the industry
- Also, partners or consultants who demonstrate exemplary support of the fastener industry

In his nomination of Jim to receive this award, Robert Ward of IFE Americans said, "Jim has been a giant in the fastener industry. He is a long time NFDA member and has been a great leader in the association and in his company, taking All Fasteners through tremendous growth and transitioning it to private equity ownership to become AIS. Jim has been a mentor and a role model to many in the fastener industry."

Jim Ruetz has spent more than 40 years in the OEM fastener and industrial MROP distribution markets. He began working full time in the family business, All Tool Sales, in 1978, putting together the company's first

catalog and tying it into the customer direct order entry system. In 1980, the company separated its fledgling fastener sales into All Fasteners, and for the next seven years, Jim served dual roles as All Tools marketing and IT manager, as well as general manager and sales for the new fastener division. "I really enjoyed the challenges of wearing a number of different hats as we grew," said Jim. In 1989, he began to focus his efforts on All Fasteners and developing the OEM VMI business. By the mid-'90s All Fasteners was predominately an OEM distributor, supplying customers with Vendor Managed Inventory systems.

In 2013, the Ruetz family sold All Tool Sales and All Fasteners to Highroad Capital Partners (HRCP). HRCP had acquired Accurate Components a year earlier. In January of 2015, Jim took on the CEO role for the companies and merged Accurate Components and All Tool/All Fasteners together to form All Integrated Solutions (AIS). The next year HRCP also acquired Great Lakes Fasteners, which was added to the AIS team. AIS consists of three divisions, located in Minneapolis MN, Grand Rapids MI, and Franksville WI. The AIS group also operates distribution centers in Fargo ND, Cedar Rapids IA, Traverse City MI, and Connersville IN. Today, AIS combines management of OEM fasteners with production MRO management and assembly tools to be one of the few distribution companies with the expertise in all three areas.

In May 2018 AIS was sold to MSC Industrial Supply Company, a \$3 billion North American leader in metalworking and maintenance, repair and operations products and services. AIS operates as a stand-alone OEM division of MSC.

VIRGINIA FASTENERS

THE GALVANIZED SOURCE



TIMBER BOLTS
HEX BOLTS
ANCHOR BOLTS
SQUARE HEAD BOLTS
LAG BOLTS

CARRIAGE BOLTS
TIE RODS
HEX NUTS
SQUARE NUTS
FLAT WASHERS

OGEE WASHERS
DOCK WASHERS
SQUARE WASHERS
ALL THREAD ROD

**Huge Inventory of Hot Dipped Galvanized Hardware
Take Advantage of Our Attractive Freight Allowances**

1-800-368-3430

P.O. Box 3108 Chesapeake, VA 23327 www.vafasteners.com

Phone 757-436-1717 Fax 757-436-1460

E-mail sales@vafasteners.com

NFDA JIM RUETZ AWARDED NFDA'S 2018 FASTENER PROFESSIONAL OF THE YEAR AWARD from page 224

Jim holds a bachelor degree in geography from the University of Wisconsin-Parkside, an associate of science in oceanographic technologies from the University of Florida Institute of Technology, and an MBA from the University of Chicago.

Jim served on the Board of Directors of the National Fastener Distributors Association from 1998-2001 and as president of the association in 2001. He served as a Board member of the Central States Industrial Distributors Association (1986-1988), president of the Wisconsin Industrial Distributors Association (1984), third district alderman for the City of Oak Creek WI (2012-2015), and as the adjunct professor at Carthage College (2016 to present).

Jim is an avid motorcycle rider, logging more than 40,000 miles in the past seven years. Some of the rides have been dedicated to the Cure Duchenne charity, which is focused on finding a cure for Duchenne

muscular dystrophy (www.cureduchenne.org).

Since 2011, supporters of Jim's rides have donated more than \$30,000 to help find a cure for Duchenne muscular dystrophy.

Jim has been married to Karen for 35+ years and has two children, Jennifer and Jason. Jennifer recently served a three-year term on the NFDA Board of Directors and is the AIS director of marketing. Jason works for Harley Davidson and never misses an opportunity to chide his dad about the fact that Jim rides a BMW motorcycle.

Jim will be presented his award at the NFDA/Mid-West Fastener Association/Pacific-West Fastener Association joint meeting in San Diego, March 14-16, 2019.

Nominations for the next Fastener Professional of the Year award will be open in January 2019.

For more information about NFDA and its activities, visit www.nfda-fastener.org. 

RICHARD HAGAN FASTENER COMPANY ACQUISITIONS COMPLETED DURING THE FIRST HALF OF 2018 from page 222



On April 3, 2018, **Ramco Specialties Inc.** ("Ramco") purchased **Copa Tool Inc.**

Founded in 1978 and located in South Lyon, Michigan (outside Detroit), Copa Tool is a machining company that manufactures high volume precision components for the automotive industry. The company specializes in powertrain components such as transmission tubes and fluid control mechanisms for Tier 1 automotive suppliers. Copa Tool generates annual net sales of approximately \$14 million and has 45 employees. Founded in 1977 and located in Hudson, Ohio, Ramco is a Tier 1 supplier to the North American automotive industry, specializing in manufacturing internally-threaded fasteners, engineered assemblies and stampings. Ramco operates from a newly-constructed 185,000 square foot manufacturing and warehouse facility and employs 175 people. The privately-owned company generates annual net sales of approximately \$100 million. With the addition of Copa Tool's screw machining capabilities, Ramco expands its product offering to automotive customers and enhances its business model as an engineered solutions provider to the Tier 1 automotive industry.

Purchase price: not available



On April 5, 2018, **Trifast plc** purchased **Precision Technology**

Supplies Limited ("PTS"). Founded in 1988 and located in East Grinstead, England, PTS is a distributor of stainless steel fasteners and precision turned parts. The company sells to other distributors and OEMs in the electronics, medical equipment, robotics, defense and petrochemical sectors. PTS operates a fully-integrated commercial website which lists more than 43,000 SKUs for sale. Based on its expertise and product depth in stainless steel and micro fasteners (along with the online store), PTS currently sell into 80 countries. PTS has 27 employees and reported net sales of £5.11 million in the 12 months ended March 31, 2017. Founded in 1973 and headquartered in Uckfield, England, Trifast is a global manufacturer and value-added distributor of industrial fasteners and Class C components. The sectors supplied by Trifast include: automotive (33% of sales), domestic appliances (22%), general industrial (19%), electronics & technology (16%) and distributors (10%). Trifast operates seven manufacturing plants and 24 distribution centers across Europe, Asia and North America. Thirty percent of Trifast's net sales are derived from manufacturing and 70% are derived from distribution (sales of product not manufactured in-house). Trifast has approximately 13,000 employees and recorded net sales of £197.6 million in the 12 months ended March 31, 2018.

Purchase price: £11.0 million (£8.5m cash/£2.5m earn-out).



On April 20, 2018, **Fastener Distribution Holdings LLC** ("FDH") purchased **Blue Sky**

Industries Inc. ("Blue Sky"). Founded in 2010 and located in Monterrey Park, California, Blue Sky is a distributor of fasteners and Class C components to the commercial aerospace and defense markets. The company supplies parts to both OEM and MRO customers and maintains a branch warehouse in Birmingham, England. Headquartered in Marina del Rey, California, FDH is a distributor of aerospace fasteners and is comprised of two business units - Aircraft Fasteners International LLC ("AFI") and Arlington International Aviation Products LLC ("AIAP"). Founded in 1964 and located in Marina del Rey, AFI is a stocking master distributor of aerospace nuts, threaded inserts, wire thread inserts and key-locking studs. Founded in 2002 and located in Arlington, Texas, AIAP is a full-line distributor of aerospace fasteners and consumable hardware, supplying commercial and military OEMs and their subcontractors. AIAP also provides customers with kitting and customized packaging services. FDH is a portfolio company of **Audax Group**, a diversified investment firm with three business platforms - private equity investments, mezzanine finance and senior debt finance. Audax Group is based in Boston, Massachusetts and manages more than \$11.5 billion of committed capital.

Purchase price: not available



On April 23, 2018, **MW Industries Inc.** purchased **LaVezzi Precision Inc.**

("LaVezzi"). Founded in 1908 and located in Bloomingdale, Illinois, LaVezzi manufactures machined components for cardiovascular devices, orthopedic & dental implants, surgical drills and components for laparoscopic & surgical devices. The company specializes in machining titanium and stainless steel components for applications requiring extremely tight tolerances. LaVezzi operates from a 50,000 square foot facility and employs around 120 people. Founded in 1973 and headquartered in Rosemont, Illinois, MW Industries manufactures a diverse range of engineered mechanical components including springs, precision stampings, wire forms, threaded inserts, metal bellows, medical devices, specialty fasteners and precision machined parts. The company is comprised of 24 business units (after the LaVezzi acquisition) spread across the United States. MW Industries is a portfolio company of **American Securities LLC**, a New York City-based private equity firm with \$23 billion of committed capital under management. American Securities purchased MW Industries just last September from another private equity firm.

Purchase price: not available

distributornews

Intercorp., an importer and master distributor of professional-grade construction fasteners under the Strong-Point® and Strongcon® brands, has revamped their product packaging, giving it a brand new look and feel that is much bolder and appealing across all of their product offerings. The new packaging will start hitting store shelves throughout the U.S. this week.



“Intercorp has a great reputation for providing high-quality products throughout the construction industry and we wanted our packaging to reflect the quality of the products inside the box,” said Director of Marketing, David Harlan. “After doing our homework, we came up with a design that we feel is one of the most eye-catching designs on the market for commercial fasteners. It is one that conveys to anyone who uses our products, that they are going to perform at a very high level.”

The new packaging design covers all of their product families including their bulk, 5lb. and 1lb. packaging. This high-impact design gives continuity and ease-of-recognition across the Strong-Point and Strongcon brands. Without a doubt, when you see these boxes, you will know the fasteners inside are of the highest quality.

Founded in 1988, Intercorp has established itself as an industry leader in the fastener distribution business. The brand consists of a variety of professional-grade fasteners including: Self-Drilling, Needle Point, Woodworking, Stainless Steel, Drywall, Pole Gripper, Outdoor, Concrete, and Cement Board screws. Strong-Point® and Strongcon® fasteners are available through construction distributors throughout the United States.

For more information on Intercorp and their Strong-Point® brand of fasteners, contact them by phone at 1-800-762-2004 or visit them on the web at www.strong-point.net.

Do You Bag Fasteners?

We have solutions for low and high volumes!

Tabletop Bagger/Printer



- ☑ Smaller Quantities
- ☑ “Next Bag Out” printing
- ☑ Options to fit your application

Hardware/Kit Bagging System

- ☑ Net-Weigh/ Counting Scale
- ☑ Designed for kit packaging
- ☑ LEDs indicate which part to load



Parts Counting/Bagging System

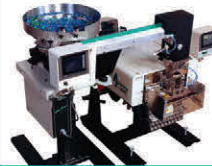

- ☑ Vibratory parts counter
- ☑ Piece Count
- ☑ Quick and Accurate

Bulk Count/Weigh Bagging System

- ☑ Vibratory Parts Counter
- ☑ Check-Weigh Scale
- ☑ Net-Weigh Counting Scale



Rotary Check/Weigh Scale

- ☑ Fast Check/Weighing
- ☑ Exceptional accuracy
- ☑ Flips to accept or reject bin

Bags!

- ☑ Custom Bags
- ☑ Dozens of stock sizes
- ☑ Blanket prices (saves money!)



Advanced Poly-Packaging, Inc.

1331 Emmitt Road • Akron, OH 44306 • USA: 330-785-4000 • fax 330-785-4010
1-800-754-4403 • sales@advancedpoly.com • www.advancedpoly.com

COMPUTER INSIGHTS INC. HOW GOOD IS YOUR USER SECURITY? from page 208

Below is an example of a User's screen with "Limit to My Menu Only" set to Yes. They are only given access to the exact functions needed for their Warehouse position.

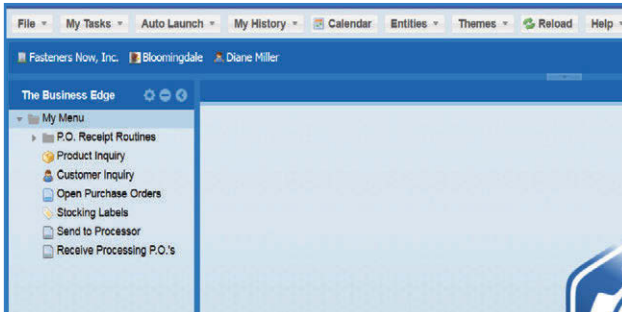

When removing access to something a user previously had access to it is important to remember clear their My History list.

Clearing a User's history takes away their access to it but leaves it in the system for Administrators to see. An employee cannot do something and hide the fact that they did it.

User Inquiries

Another important aspect of security is being able to see what people are actually doing. Reviewing User History is often an eye-opening experience.

Management has access to information detailing what menu items users were in. The User History Inquiry shows by user, the Programs they were in by Date and Time.

The Report History Inquiry will show every report that was generated by User, Date and Time.

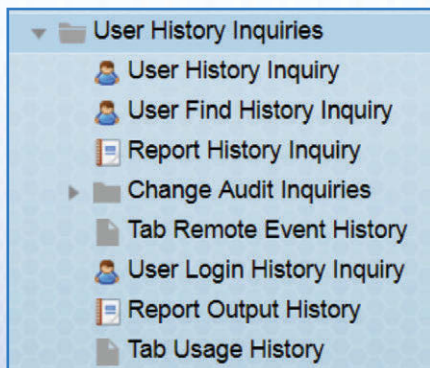

The Business Edge

In the Change Audit Inquiry Menu shown below, management can view changes made to Master Records and Documents. If someone is wondering how re-order points were changed in Inventory they can easily find that information for a single part or a range of parts within a date range. There are also Audit Inquires available through the standard Inquiries from the Tool bar.

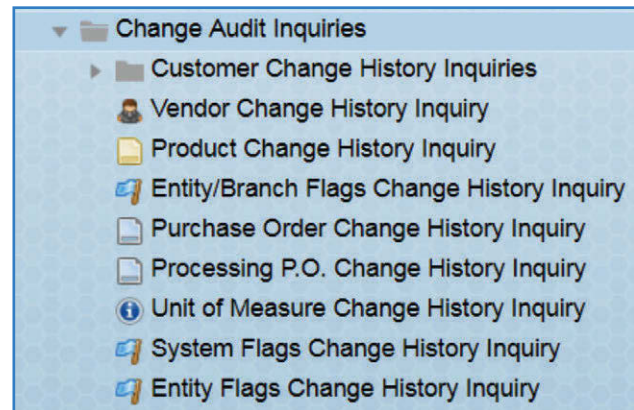









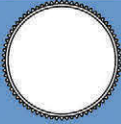
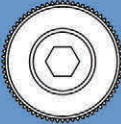
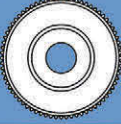
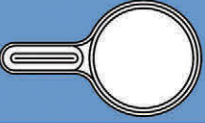
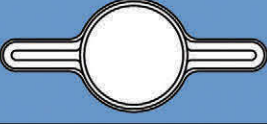
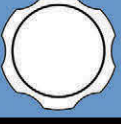
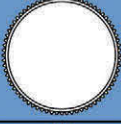
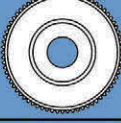

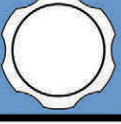







No Perfect Answer

There is no perfect answer to how user security can be controlled. Trusted employees can find themselves under pressure and do things that they normally wouldn't do. However, when it comes to security, the more you know, the better off you are. Controlling access to sensitive information in the first place is the best answer.

Also, if employees are guided through what they are expected and allowed to do by your software itself, you will not be needlessly tempting them to do the wrong thing. It is good to review how tight (or loose) your security is and take action if it is not serving your best interests. 

shear-LOC[®] QUICK REFERENCE GUIDE

INCH SERIES		KNURLED SERIES MALE THREAD #4 THROUGH 5/16. Available knobs only, assemblies and in kits. This style offers the most common knob for light locking applications.
		KNURLED SERIES WITH KEY DRIVE MALE THREAD #4 THROUGH 5/16. Available assembled only. This is the same style as the above series but allows for dual hand or hex wrench locking and adjustments.
		KNURLED SERIES FEMALE THREAD WITH ALUMINUM INSERTS #4 THROUGH 5/16. Available assembled only and in kits. These match the above series for design uniformity.
		L-SERIES MALE THREAD #10 THROUGH 5/16. Available knobs only, assemblies and in kits. This style is useful in close quarter applications.
		TEE SERIES MALE THREAD #10 THROUGH 3/8. Available knobs only, assemblies and in kits. This style allows for a little extra torque.
		ROSETTE SERIES MALE THREAD 1/4 THROUGH 3/8. Available knobs only, assemblies and in kits. This style offers a more decorative look.
METRIC SERIES		KNURLED SERIES MALE THREAD M3 THROUGH M8. Available knobs only, assemblies and in kits.
		KNURLED SERIES FEMALE THREAD WITH ALUMINUM INSERTS M3 THROUGH M8. Available assembled only and in kits.
		TEE SERIES MALE THREAD M5 THROUGH M10. Available knobs only, assemblies and in kits.
		ROSETTE SERIES MALE THREAD M6 THROUGH M10. Available knobs only, assemblies and in kits. <i>NOTE: All knobs for male thumbscrews are cold formed onto standard socket head cap screws.</i>
LASER	INFO GUIDE SERIES STANDARD OR CUSTOM Knobs are black acetal resin with white engraving	
	     	        

TECHNICAL SUPPORT GO TO WWW.SHEAR-LOC.COM OR CALL 800-775-5668

ROBERT FOOTLIK PREPLANNING CAN SAVE YOUR BUSINESS AND YOUR LIFE *from page 212***Regroup**

- Designate someone to take charge immediately, provide them with the authority, responsibility and budget to proceed as previously planned.
- Guard the area against looting, further damage and unauthorized entry.
- Organize internal teams for salvage, repair or other tasks.
- Obtain outside help and services as required.
- Re-establish communications using cell phones, wireless internet (from a neighbor, coffee shop, library) and other means.
- Communicate with all personnel with regular updates on decisions and goals.

Notify

- Insurance carriers.
- Appropriate utilities
- Employees and their families

- News media
- Vendors-wholesalers, manufactures reps and other suppliers
- Customers

Rebuild

- Start salvage operations and evaluate the inventory that is damaged as well as intact.
- Decide what to salvage and how to mitigate additional damage with tarps, tents, etc.
- Find replacement facilities, equipment, computers, pallet racks, shelving and other vital hardware.
- Arrange for the needs of your people, including food, water, chairs, desks/tables and supplies.
- Set up liaisons with suppliers, competitors, and others as early as possible.
- Purchase emergency equipment to deal with after effects.
- Restore security and fire protection systems. 

ROBERT FOOTLIK

DEREK DANDY BOLTED JOINT CONSISTENCY WITH STAINLESS STEEL FASTENERS *from page 214***Other Uses**

In addition to the advantages in threaded joints, Kolsterising® has also been utilized to improve fatigue strength due to the high compressive stresses generated through the diffusion process. The compressive stresses created through Kolsterising® will be more significant and consistent to those created through shot peening, regardless of part geometry. The improvements to fatigue strength and fatigue life have been of interest to those in the spring industry as it is a challenge they have to work with on a daily basis. Kolsterising® had its first success in a type of high point stress sealing application. The high surface hardness, coupled with the ductility of the hardened layer, provided the only solution to that particular market's pain point. This application can be closely related to how a set screw functions. There is potential to increase the holding power due to the increased "biting" effect into a mating shaft. This increased "biting" effect can then lead to less set screws required or moving to smaller set screws. As mentioned previously, this can lead to savings with the fasteners themselves as well as in machining operations.

[1] K. Clark (2017), *The Effects of Low Temperature Carbon Diffusion Treated Fasteners on Thread Galling Resistance*, 2017 ASME Vessel and Piping Conference, Hawaii, 2017.

Customer Testimonial

"Since we have started Kolsterising our stainless steel nuts, bolts, and screws, we are no longer concerned about hardware breaking or galling. Because of this, we have seen a rise in efficiency and productivity. Our assemblers love the ease of use and feel that it would be a benefit in every application."

North Park Metalworkers – Rhinebeck, NY

About The Author

Derek received his B.S. in Material Science & Engineering from Rutgers University in 2000. He then spent 10+ years in the fastener industry prior to joining Bodycote in August 2016 with a strong focus on further developing the fastener market here in North America. Derek can be reached by email: derek.dandy@bodycote.com, by phone: 848-213-1484 or visit our website at www.bodycote.com/s3p 

UMETA

OF AMERICA INC.

UMETA of America offers the highest quality grease guns, grease fittings and all the accessories to address your lubrication needs. We are the leading global provider of over 1,500 grease fittings in standard and non standard sizes. UMETA is also prepared to create custom parts according to buyer specifications.



- British Standard
- Metric DIN 71412
- J I S
- OEM Quality
- ISO 9001 Certified
- Military Specified
- SAE
- Stainless Steel 303 & 316
- Zinc plated Industrial grade steel
- Brass

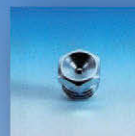

Erin Cave
 General Manager
 800-595-5747
 USA@UMETA.COM

WWW.UMETA.COM

147 Bluewing Lane Mooresville, NC 28117

We make it move.



News Plus More.



- Feature Articles
- Fastener Stocks
- Product News
- Fastener History
- Classifieds
- Daily Quiz
- FIN Calendar
- Association News
- Trade Shows
- Fastener Quality
- Archives

GLOBAL
 FASTENER NEWS.COM

Tel 503 335-0183 E-mail FIN@GlobalFastenerNews.com
 2207 NE Broadway #300, Portland, Oregon 97232-1608 USA

Vertical Integration

Delivering quality products should always be a top priority, especially when dealing with safety-critical applications. Vertically integrated manufacturing processes generally lead to tighter process controls and process optimizations, and often times, many less hands touching the product. This can help guarantee stricter controls, and not to mention products that have shorter lead times and lower costs. Additionally, with a vertically integrated manufacturing system, you have a higher chance of product customizations that won't blow your budgets or project timeframes either.

Product Traceability and Accountability

Make sure that your vendor stands fully behind the product they provide to you by offering proper product lot traceability and documentation. The security provided by a traceable lot is unparalleled if a problem ever arises that requires records of the manufacturing process. Look for traceability back to the production lot, the material and processes used in its production. This provides you as the OEM with the correct and proper tracking records and liability maintenance back to the supplier. If a supplier does not know where the raw materials came from, or cannot provide you with product formulation or material or finish treatment documentation, you must question whether you can risk continuing to rely on this supplier.

Comprehensive Technical Support and Customer Service

Along the same lines as the previous factor, you want a supplier that is proud of and willing to fully support the products they are offering to you. Not only will this help expedite things if a problem were to ever arise in regards to faulty products or a recall, but down the line, if you will ever need help identifying additional solutions

for your needs, need product certifications or installation advice. Think about the downstream impacts when looking for a supplier, as many suppliers tend to cut the quality of their customer service teams in an effort to save on costs. A quick test can be as simple as calling your current suppliers to see how long it takes to get to a human representative.

An Open Door Policy

This factor can be the make-or-break rule. See if your supplier is hesitant to give you a plant tour or to see how your products are being made. If there's more than a moment of hesitation, you have identified a potential red flag. Oftentimes companies will put these rules in place that help to obfuscate the truth. This may be done intentionally, or not; however, you must demand full transparency to the production process in order to fully guarantee the above.

The Ultimate Checklist to Audit and Select a Supplier.

We know how difficult it is to properly vet, manage, and continually audit all of your regular suppliers. We created this guide for you to make your life a little bit easier by boiling down the complexities of what to look for in a trusted and quality supplier to these top factors.

Vertical Integration

Vertically integrated manufacturing leads to tighter process controls and process optimizations. This also helps to guarantee strict controls due to less hands touching the final product and these types of processes have shorter lead times and lower costs in the majority of cases. More customization is often also available.



Product Traceability

The security provided by a traceable lot is unparalleled if a problem ever arises that requires records of the manufacturing process. Look for traceability back to the production lot, the material and processes used in its production. This provides you as the OEM with the correct and proper tracking records and liability maintenance.



Comprehensive Support

You want a supplier that is proud of and willing to fully support the products they are offering to you. A quick test can be as simple as calling your current suppliers to see how long it takes to get to a human representative.



Open Door Policy

See if your supplier is hesitant to give you a plant tour or to see how your products are being made. If there's more than a moment of hesitation, you have identified a potential red flag. You must demand full transparency to the production process in order to fully guarantee the above.



Wide Range of Products

Seeing as how stringent and potentially tough it is to properly vet and clear suppliers, look for suppliers with a wide array of products that you can feel good about purchasing. This will limit the overall risk your company takes in future purchases if a company that you fully trust supplies you with a range of products.



PAC-WEST FALL CONFERENCE - GROUSE MOUNTAIN LODGE WHITEFISH, MONTANA - AUGUST 8-11, 2018

PHOTOS COURTESY OF
GREG CHRISTENSEN



RICHARD HAGAN FASTENER COMPANY ACQUISITIONS COMPLETED DURING THE FIRST HALF OF 2018 from page 226



On April 27, 2018, **Colony Hardware Corporation**

purchased **Cook Iron Store Company Inc.** ("Cook Iron Store"). Founded in 1907 and located in Rochester, New York, Cook Iron Store is a distributor of a full range of MRO supplies for construction and general industrial customers. The majority of the company's customers are located within a 150 mile radius of Rochester, but the company also maintains an online store named www.heavydutystore.com. Founded in 1988 and headquartered in Orange, New York, Colony Hardware is a regional distributor of fasteners, power & hand tools, safety equipment and consumable supplies for the commercial construction and general industrial markets. The company provides jobsite delivery services, along with equipment and power tool rental and repair services. With the addition of Cook Iron Store, Colony Hardware now has 25 stores / warehouses in eleven states. Colony Hardware is a portfolio company of **Tailwind Capital Group LLC** a New York-City-based private equity firm with more than \$3 billion of committed capital under management.

Purchase price: not available



On April 30, 2018, **MSC Industrial Supply Co.** ("MSC Industrial") purchased

All Integrated Solutions Inc. ("All Integrated"). Founded in 1962 and headquartered in Franksville, Wisconsin, All Integrated is a distributor of fasteners, Class C parts and general industrial supplies. The company specializes in providing customers with advanced supply chain management solutions. All Integrated supplies a diverse range of OEM and MRO customers and operates eight warehouses located in Wisconsin (2), Michigan (2), Minnesota, Iowa, Indiana and North Dakota. The company recorded net sales of \$66 million in calendar 2017 and employs 135 people. Founded in 1941 and headquartered in Melville, New York, MSC Industrial is a direct marketer and distributor of a broad range of metalworking and MRO supplies. The company operates through a network of twelve customer fulfillment centers (8 in the United States, 3 in Canada and 1 in the United Kingdom) and 100 branch offices (99 in the US and 1 in the UK). In the 12 months ended September 2, 2017, MSC Industrial recorded net sales of \$2.9 billion and employs more than 6,500 employees. The seller of All Integrated was **High Road Capital Partners LLC**, a New York City-based private equity firm with \$470 million of committed capital under management.

Purchase price: \$86 million



On April 30, 2018, **Colony Hardware Corporation** purchased **Brinker Brown Fastener & Supply Inc.**

("Brinker Brown"). Founded in 1985 and located in Fort Myers, Florida, Brinker Brown is a distributor of fasteners, power & hand tools, generators and a broad range of brand name construction supplies and equipment. The company's customer base consists primarily of commercial construction contractors, along with the mechanical, electrical, roofing and plumbing trades. Brinker Brown maintains a 30,000 square foot store / warehouse in Fort Myers and a branch located in Naples. Founded in 1988 and headquartered in Orange, New York, Colony Hardware is a fast-growing distributor of fasteners, power & hand tools, safety equipment and consumable supplies for commercial construction and general industrial customers. The company specializes in just-in-time jobsite delivery, along with equipment and power tool rental and repair services. Brinker Brown is Colony Hardware's third acquisition this year and the company now has 27 stores / warehouses in eleven states. Colony Hardware is a portfolio company of **Tailwind Capital Group LLC** a New York-City-based private equity firm with more than \$3 billion of committed capital under management.

Purchase price: not available



On June 4, 2018, **Ideal Tridon Holdings Inc.** ("Ideal-Tridon") purchased **Clamp**

S.r.l. Founded in 1983 and headquartered in Milan, Italy, Clamp is a manufacturer and distributor of clamps, clips and cabling products for the industrial market in Europe. Clamp began as a distributor and in 1997 it began developing and manufacturing its own products in a factory outside Milan. Today approximately 40% of net sales are derived from its own manufacturing plant and the company employs approximately 30 people. Founded in 1913 and headquartered in Smyrna, Tennessee, Ideal-Tridon is a designer and manufacturer of specialty clamps, couplings and strapping. The company's diverse product range is utilized by the automotive, heavy truck, petroleum, chemical, marine, plumbing, irrigation and general industrial sectors. Ideal-Tridon's fastening and sealing products are manufactured and distributed globally, with ten facilities in the United States (4), Mexico (2), Poland, India, Japan and China. Ideal-Tridon is a portfolio company of **Snow Phipps Group LLC**, a New York City-based private equity firm with \$2.4 billion of committed capital under management.

Purchase price: not available

MID-WEST FASTENER ASSOCIATION TABLE TOP SHOW ELK GROVE VILLAGE, IL - JUNE 4, 2018

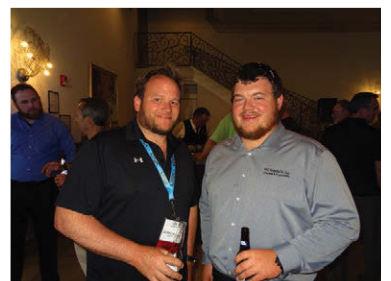

RICHARD HAGAN FASTENER COMPANY ACQUISITIONS COMPLETED DURING THE FIRST HALF OF 2018 from page 234

M.F. INOX S.R.L.

On June 7, 2018, **Vimi Fasteners S.p.A.** purchased **M.F. Inox**

S.r.l. Founded in 1992 and located in Albese con Cassano, Italy, M.F. Inox is a manufacturer of hot-forged and machined bolts, nuts, eyebolts and fittings produced from stainless steel and "exotic" high nickel alloys. The company's fasteners are used for oil & gas refining, chemical processing, shipbuilding, pumps & valves, energy production and infrastructure projects. In the 12 months ended December 31, 2017, M.F. Inox recorded net sales of €6.4 million and employed 20 people. Approximately 67% of the company's sales are to customers outside Italy. Founded in 1967 and located in Novellara, Italy, Vimi Fasteners manufactures externally-threaded fasteners predominantly for automotive, heavy truck, agricultural equipment, marine and general industrial applications. The company specializes in critical applications such as engine bolts, manifold bolts, powertrain components and braking systems. Vimi Fasteners generated net sales of €43.4 million in calendar 2017 and employs approximately 190 people. A privately-owned company, Vimi Fasteners shares were listed on the Italian Stock Exchange (Borsa Italiana) on August 2, 2018 (symbol: VIM.MI).

Purchase price: not available

TUCKS O'BRIEN

IRELAND'S PREMIER TOOL DISTRIBUTOR

On June 11, 2018, **Dormole Limited** purchased **Tucks O'Brien Ltd.** and its sister company, **Tucks Fasteners & Fixings Ltd.**

(referred to collectively as "Tucks"). Founded in 1877 and located in Dublin, Ireland, Tucks O'Brien is a distributor of hand tools, power tools and general MRO supplies. The company is an authorized distributor for Makita, Stanley, Irwin, Bahco and other premier power tool manufacturers. Founded in 1979 and also located in Dublin, Tucks Fasteners is an independent wholesale distributor of packaged fasteners, along with a range of consumable hardware and supplies for end-users and distributors. Both companies supply customers across Ireland, including general construction, electrical wholesalers and hardware retailers. Founded in 1974 and headquartered in Kent, England, Dormole is a privately-owned holding company for six companies in England and France. Those companies are: i) Toolbank Ltd. (tooling distribution); ii) Home Hardware Distribution Ltd. (hardware distribution); iii) BIZ Power Tool Ltd. (power tool distribution); iv) Olympia Tools Ltd. (hand tool and workwear distribution); v) Forgefix Ltd. (fastener distribution); and vi) Denuzière S.A.S. (tool manufacturer and distributor in Lyon, France).

Purchase price: not available



On June 15, 2018, **Optimas OE Solutions LLC** ("Optimas") purchased **Circle Bolt & Nut Co. Inc.** ("Circle Bolt").

Founded in 1979 and headquartered in Kingston, Pennsylvania, Circle Bolt is a distributor of fasteners and Class C components. The company offers customized vendor managed inventory (VMI) programs, along with custom packaging, light assembly and engineering / technical support. Circle Bolt operates seven full-service branches in: Atlanta, Georgia; Charlotte, NC; Tupelo, Mississippi; Bristol, Indiana; Oklahoma City, Oklahoma; Phoenix, Arizona; and Portland, Oregon. The company supplies both OEM and MRO accounts. Optimas was formed in July 2015 when American Industrial Partners L.P. ("AIP"), a New York City-based private equity firm, purchased the Anixter Fasteners division of Anixter International Inc. (NYSE: AXE) and changed the name to Optimas. Headquartered in Glenview, Illinois, Optimas is a manufacturer and distributor of fasteners and Class C components. The company specializes in providing advanced supply chain management services to customers in the automotive, heavy truck, agricultural machinery, recreational vehicle and power generation industries. Optimas operates 60 distribution service centers in 16 countries and employs more than 1,600 people. Optimas generates annual net sales of approximately \$885 million and is still owned by AIP.

Purchase price: not available



On June 25, 2018, Automotive Vehicle Company, doing business as **Auveco Products**,

purchased **Marli Manufacturing Inc.** ("Marli"). Founded in 1980 and located in Binghamton, New York, Marli is a distributor of fasteners and mechanical components to the North American automotive aftermarket. The company's product range includes engine head bolts, intake manifold bolts, exhaust hardware, pipe plugs, oil drain plugs & gaskets and many more. Marli supplies more than 1,000 aftermarket components to distributors, engine remanufacturers and quick lube chains across the country. Founded in 1916 and located in Cold Spring, Kentucky, Auveco Products distributes a broad range of fastener products to the auto body repair aftermarket and to the general industrial MRO market. Auveco Products sells through a network of master distributors who subsequently service hundreds of thousands of collision centers, repair shops and dealerships. The acquisition of Marli expands Auveco Products' product range and expands its customer base into engine remanufacturers and quick lube centers. Auveco Products is a portfolio company of **Tenex Capital Management L.P.**, which purchased the company in January of this year.

Purchase price: not available



MFDA AWARDS 2018 SCHOLARSHIPS EAST RUTHERFORD, NJ - JUNE 14, 2018





Campbell Fittings

On June 27, 2018, **Ideal Tridon Holdings Inc.** (“Ideal Tridon”) purchased **Campbell Fittings Inc.** Founded in 1957 and headquartered in Boyertown, Pennsylvania, Campbell Fittings develops and manufactures fittings, couplings and clamps for the industrial hose connection market. The company’s broad product range is used for applications such as air, steam, petrochemical, chemical processing and well water. Campbell Fittings sells to both distributors and end-users (OEMs). The company has a distribution warehouse in Houston, Texas. Founded in 1913 and headquartered in Smyrna, Tennessee, Ideal Tridon is a designer and manufacturer of specialty clamps, couplings and strapping. The company’s diverse product range is used by the automotive, heavy truck, petroleum, chemical, plumbing, irrigation and general industrial sectors. Ideal-Tridon’s fastening and sealing products are manufactured and distributed globally with ten facilities in the United States (4), Mexico (2), Poland, India, Japan and China. Ideal-Tridon is a portfolio company of **Snow Phipps Group LLC**, a New York City-based private equity firm with \$2.4 billion of assets under management.

Purchase price: not available



On June 27, 2018, **Intermediate Capital Group Inc.** (“ICG”) purchased **Etanco S.A.S.** Founded in 1952 and headquartered outside Paris, Etanco designs, manufactures and distributes specialty fasteners for the commercial construction market. The company offers more than 80,000 SKUs focused primarily on three construction applications: i) the building envelope (roofing, waterproofing, cladding and facade); ii) the building structure (anchors, chemical adhesives and wood solutions); and iii) the building interior (anchors, chemical adhesives and electrical solutions). Etanco

operates five production sites in France (3), Italy and Poland and maintains six sales offices in Germany, Belgium, the United Kingdom, Czech Republic, Poland and Romania. In calendar 2017, Etanco recorded net sales of €195 million and EBITDA of €35 million. Sixty percent of net sales are to customers in France, with the balance exported to more than 20 countries across Europe. Founded in 1989 and headquartered in London, ICG is a diversified asset manager with €32.9 billion of assets in third party funds and proprietary capital. ICG made an equity and mezzanine debt investment in Etanco, along with senior management. ICG is listed on the London Stock Exchange (ICP.L).

Purchase price: €400 million



On June 29, 2018, **Primary Capital Partners LLP** (“Primary Capital”) purchased **VJ Technology Limited** (“VJT”). Founded in 1995 and located in Ashford, England, VJT is a distributor of fasteners and consumable supplies to the commercial construction and civil engineering markets. The company stocks more than 13,000 SKUs and specializes in providing jobsite delivery and technical / engineering support to customers. In the 12 months ended December 31, 2017, VJT generated net sales of £31.0 million and EBITDA of £4.1 million. Primary Capital is a private equity firm which invests in growing companies alongside entrepreneurial management teams. Primary Capital has offices in London and Manchester, England and typically invests in companies with enterprise values between £20 million and £100 million. The seller of VJT was **SIG plc**, a building products distributor specializing in three core product areas: insulation products, roofing products and non-residential interior products (ceilings, partitions, dry lining, floor coverings, etc.). SIG recorded calendar 2017 net sales of £2.9 billion and its shares are traded on the London Stock Exchange (SHI.L).

Purchase price: £29.7 million 



reach new heights.

ALL COMMUNICATIONS WILL BE HELD IN THE STRICTEST OF CONFIDENCE

Pinnacle Capital Corporation
has been serving the Investment Banking
needs of the Global Fastener Industry since 1993.

- * BUSINESS SALES & DIVESTITURES
- * ACQUISITIONS & ACQUISITION SEARCHES
- * STRATEGIC INVESTMENTS & JV PARTNERSHIPS
- * DEBT & EQUITY FINANCINGS
- * BUSINESS VALUATIONS & FAIRNESS OPINIONS

PINNACLE CAPITAL CORPORATION | TEL 212-267-8200 | WEB www.pinnaclecapitalcorp.com

ROTOR CLIP HOW TO CHOOSE A QUALITY SUPPLIER *from page 232*

A Wide Range of Product Offerings

Seeing as how stringent and potentially tough it is to properly vet and clear suppliers, look for suppliers with a wide array of products that you can feel good about purchasing. This will limit the overall risk your company takes in future purchases if a company that you fully trust supplies you with a range of products.

In Conclusion

Now that we've gotten through the risks of not properly vetting your suppliers and how that may impact your production line or bottom line, we hope that you have a better idea of what to look for when shopping for suppliers.

If you are looking for a retaining ring supplier that you can rely on and trust, give Rotor Clip a call. Rotor Clip

is 100% vertically integrated manufacturing facility, with everything produced in our facilities in the US and EU. We employ a large team of dedicated Engineers, Technical Salespeople and Customer Service Agents, so help and support is only a phone call away. Rotor Clip is also the only manufacturer that produces a full line of Inch, DIN, ANSI metric and JIS retaining rings to world standards, as well as a complete line of Tapered Section, Constant Section and Spiral Retaining Rings, wave springs and self-compensating hose clamps. There are over 50 different styles and over 1000 part numbers to fit virtually every application, and if one of those doesn't work, we'd be happy to work with you on a custom solution. We would love the chance to prove ourselves to you and convince you that Rotor Clip is the smart choice when it comes to retaining rings, wave springs, and hose clamps. 

advertisers index

#

3Q, INC. 64
Split Lock Washers – large diameter.
Tel (630) 405-8492

A

ABBOTT INTERFAST 116
Screw machine products, CNC high precision, cold headed specialist, custom & standard knobs. Global sourcing, direct import/customers clearance. Large global supply base.
Tel (888) 490-9424
Fax (847) 459-4076

ACS MANUFACTURING, INC 109
Formed spring steel fasteners
Tel (888) NUTS-R-US
Fax (847) 695-6336

ADVANCED POLY-PACKAGING 227
Quality baggers, parts counters, scales, bags and conveyors for affordable fastener packaging.
Tel (330) 785-4000
Fax (330) 785-4010

AJAX WIRE SPECIALTY CO., INC. 97
Wire spring manufacturer. Short and long runs, all sizes, all lengths.
Tel (855) 966-AJAX (2529)
Fax (516) 935-2334

ALBANY STEEL & BRASS 63
Specialty Tapping Screws - Swageform
Tel (312) 733-1900
Fax (312) 733-9887

ALFA TOOLS® 23
For over 40 years, Alfa Tools has partnered with Fastener Distributors to supply cutting tools, threading tools, fastener driving tools, and abrasives made in the USA.
Tel (800) 253-2532

ALL AMERICAN WASHER WERKS 112
Quality producers of washers and stampings
Tel (847) 566-9091
Fax (847) 566-8381

ALL ELECTRONICS HARDWARE 209
Designer, manufacturer and supplier of high quality plastic hardware to the fastener, electronics and electrical industries. Circuit board supports, card guides, cable clamps and clips, cable ties, wire routing devices are featured.
Tel (800) 778-7234
Fax (847) 658-4006

ALLOY & STAINLESS FASTENERS 82, 83, 84
Supplies special metal fasteners in over 150 material grades and over 25 coatings and platings. ASF utilizes over 250 machines with a 10,000 ton inventory with emergency 24-7 on call service.
Tel (713) 466-3031
Fax (713) 466-9591

ALPHA-GRAINGER MFG. CO. 25
Electronic hardware, captive screws, shoulder screws, spacers & standoffs
Tel (508) 520-4005
Fax (508) 520-4185

ALUMINUM FASTENER SUPPLY 141, 203
The only exclusive aluminum fastener supplier of made in the USA products. 6,500 line items in stock with same day shipping. It's what we do.
Tel (800) 526-0341
Fax (239) 643-5795

AMERICAN BELLEVILLE 131
Belleville Washers, Belleville Springs, Disc Springs, Flange Washers, precision-machined custom components. Contract manufacturing services – stamping, CNC lathe and mill machining, grinding, heat treating.
Tel (440) 721-8350
Fax (440) 266-0704

AMERICAN IMPERIAL SCREW CORP. 199
Push on hats, push on bolt retainers, locknuts, self-treading locknuts and washers, regular washer locknuts, push-on retainer fasteners and wing nuts, adhesives and metal anchors.
Tel (800) 431-2391
Fax (845) 354-4377

AMPG 7, 55
Domestic manufacturer of shoulder screws, button head sex bolts, flat head sex bolts, prairie bolts, non-standard flat washers, and machined specialties from stock. Print to part in 7 days.
Tel (317) 472-9000
Fax (317) 472-9010

ATTICA AUTOMATION 89
Leading designer and manufacturer of vision inspection and automation equipment for multiple industries. Each machine is custom designed according to the customer's needs.
Tel (248) 236-2454

AZTEC WASHER COMPANY 185
Master Seal® Washers are more than just washers. Features include: Standard and customized shapes stamped daily.
Tel (858) 513-4350
Fax (858) 513-4305

B

BAR STOCK SPECIALTIES, INC. 86
Metal bar processing; drawing, peeling, grinding and cutting. Long length stainless bar up to 60 foot.
Tel (713) 849-0055
Fax (713) 466-3583

BARBAROTTO INTERNATIONAL MACHINERY 97
New and used machinery for the fastener and wire industry including new and used Automatic Packaging Equipment for hardware. Weigh-count and bagging is a specialty.
Tel (516) 594-1300
Fax (516) 594-1311

BAY SUPPLY 3
Fastener & Tooling Super Warehouse. Top brands at bottom prices. Ship to over 200 countries.
Tel (516) 294-4100
Fax (516) 294-3448

BEACON FASTENERS AND COMPONENTS, INC. 119
Thread forming screws, DIN 7500 metric thread forming screws, thread cutting screws, SEMS screws, high-low tapping screws, sheet metal screws and specials.
Tel (800) 669-2658

BIG RED FASTENERS, INC. 103
Now stocking Xylan and Clear Cad B7 studs and nuts. Your full-service stocking distributor of all bolts, nuts, studs, washers, machine screws, tapping and self-drilling screws. USA Products. We are on the Williams Pipeline AML.
Tel (918) 251-7291
Fax (918) 251-7311

BRADLEY GROUP OF COMPANIES 155
Preapplied Adhesives and Sealants. Loctite Dri-Loc, 3M Scotchgrip, Nylon Patch, Tec-Flon Thread-Masking, Plastisol, Head Identification Marking, and Casting Impregnation. Authorized Coating Partner for Precote® USA.
Tel (800) 201-7381

BRIKSEN STAINLESS 121
Master distributor of inch and metric stainless fasteners. Competitive pricing. 24hr turnaround.
Tel (800) 962-1614
Fax (321) 233-8665

BRIGHTON-BEST INTERNATIONAL OUTSIDE BACK COVER
Socket & square head set screws, hex keys, L-Nine products, Grade 8 hex head, shoulder bolts, pipe plugs, dowel springs, nuts & metrics, hand tools and full stainless line.
Tel (800) 275-0050

BRYCE FASTENER 154
Premium, high-torque fasteners. The largest variety of proprietary, tamper-proof fasteners on the market. 100% American made.
Tel (800) 558-1082

BTM MANUFACTURING 93
Leading manufacturer of bent and threaded products. U-bolts, J-bolts, studs, anchor bolts, eye bolts and bent/threaded product manufactured to custom specifications. Quality, value, and reliability for more than 50 years.
Tel (800) 369-2658
Fax (816) 331-0473

BUCKLEY QC 223
Self-locking fasteners
Tel (800) 344-3874
Fax (716) 662-0669

THE SPECIALISTS IN STUDS & THREADED RODS



● **THREADED RODS**

0-80 TO 3 1/2" Diameter
Lengths to 20 Feet
Right or Left Hand Thread

● **SPADE BOLTS**

6-32 to 3/4-10 Diameter
With or Without Holes

● **CUSTOM BENT BOLTS**

U-Bolts - Rnd & Sqr Bend
J, L, V & Eye Bolts
Anchor & Hook Bolts

● **MATERIALS**

Carbon Steel (All Types)
Alloy Steel: 4037A, 4140, 8620
B-7, B-16, Stainless Steel
Copper, Brass, Bronze, Nickel
Alloys, Monel, Aluminum

● **STUDS**

0-80 to 3 1/2" Diameter
Continuous Thread
Single End Thread
Double End Thread
Roll or Cut Thread
Right or Left Hand Thread
UNC-Course Thread
UNF-Fine Thread
UNEF-Extra Fine Thread
Special Pitch Threads
Acme Threads
Metric Threads
End Slotted
Turned Down Diameter

● **SCREW MACHINING**

● **CNC PRECISION MACHINING**

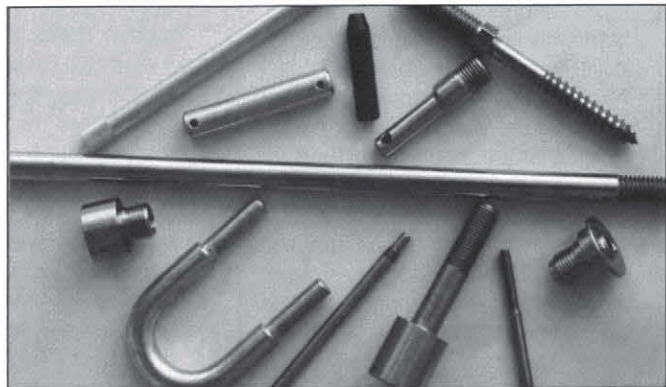

TUTTLE
MFG. CO.



A Division of Arlington Fastener Company
1032 W. Northwest Hwy, P.O. Box 590 Barrington, IL 60010
(847) 381-7713 ph • (847) 381-9450 fx

Visit us at thomasregister.com to view our catalog

advertisers index

C

- CAPITAL MARKETING 64**
Sales & Marketing strategies from a premier agency serving North Carolina, South Carolina, and Virginia.
Tel (336) 906-9401
- CARVER CONSULTING 205**
Fastener consulting and CAD services. Sketch or sample to mfr-ready print in one day.
Tel (619) 440-5888
- CAVALIER INDUSTRIAL SPECIALTIES 85**
Manufacture acorn, dome, flat and radius cap styles - small and large diameters. Custom fasteners. Our manufacturing processes include forging, turning, milling, drilling, slotting, broaching, grinding, and roll threading. Emergency 24-7 service.
Tel (713) 983-0055
Fax (713) 983-0058
- CENTURY FASTENERS CORP. 27**
Authorized stocking distributor of Cherry Aerospace parts and is an ISO9001:2000 and AS9120 Rev. A certified company.
Tel (855) 332-4445
- CERAMCO, INC. 51**
Ceramco solid ceramic fasteners and custom components overcome high temperatures, corrosive environments and non-corrosive and hold a vacuum. ISO 9001 and ITAR. Made in America.
Tel (603) 447-2090
Fax (603) 447-3906
- CHICAGO HARDWARE & FIXTURE CO. 77**
Mfrs of Wire Rope and Chain Fittings, Industrial and Marine Hardware and Allied Products
Tel (847) 455-6609
Fax (847) 455-0012
- COMPONENT PACKAGING 149**
Contract packager specializing in the fastener industry - automated or hand bagging, shrink packaging and order assembly.
Tel (417) 624-9395
Fax (417) 624-2303
- COMPUTER INSIGHTS 19**
Offering "The Business Edge," a complete integrated system for fastener distributors
Tel (800) 539-1233
Fax (630) 893-4030
- CONTINENTAL-AERO 71**
Locknuts - metric, all-metal, nylon insert flange, all-metal flange locknuts. Aero-Flex - the all-metal prevailing torque locknut and floorboard screws.
Tel (866) 419-5084
- COPPER STATE BOLT & NUT 47**
Domestic manufacturer of structural bolts. Standard and metric sizes available. 45 years of quality products - made in the USA.
Tel (800) 528-4255
Fax (602) 272-3316
- CRAFTECH INDUSTRIES 133**
Manufacturer of high-quality parts at competitive prices. Crafttech serves a variety of industries including semiconductor, aerospace, medical, telecom, chemical, electronics and more. Capabilities include injection molding, mold building, screw machining and CNC machining. Standard and custom parts are manufactured from low volume to high volume runs.
Tel (800) 833-5130
Fax (518) 828-5130
- CRESCENT MANUFACTURING 185**
Specializing in miniature fasteners
Tel (860) 673-2591
Fax (860) 673-5973
- CHRISLYNN THREADED INSERTS 219**
Professional thread repair. Same day shipping, no minimums.
Tel (800) 926-1495
Fax (888) 526-4566
- CURE DUCHENNE 39**
Tel (949) 872-2552 - To Donate: www.CureDuchenne.org
- D**
- DALE FASTENER SUPPLY 139**
U-bolts, anchor bolts, studs, O-rings, gaskets, Flexloc nuts, socket head cap screws, pipe plugs, spiro pins, Pro-Coat U-Bolt™. 24 hour service, specials are made to order with short lead times since 1959.
Tel (713) 928-3437
- DARLING BOLT 165**
Large and special hex cap screws & socket products in additional to 12-point flange screws
Tel (800) 882-0747
Fax (586) 757-1555
- THE DECC COMPANY 127**
DECC is a rack-spray coating applicator of Magni, Doerken and Whitford coatings for components that cannot be dip-spun, like flat washers and large bolts.
Tel (616) 588-2850
Fax (616) 245-8865
- DELTA SECONDARY 137**
Cut off & chamfer, cut threading, cross drilling, tapping, turning, milling, slotting, grooving.
Tel (630) 766-1180
Fax (630) 766-1285
- DISTRIBUTION ONE 61**
ERP Software for Fastener Distributors capable of running the entire operation, efficiently & profitably.
Tel (856) 380-0629
Fax (856) 222-0061
- DISTRIBUTOR'S LINK 247**
Tel (800) 356-1639
Fax (239) 643-5220
- DUNKLEY INTERNATIONAL, INC. 102**
Research, design, software development, welding and fabricating, manufacturing, and distribution of the high-speed sorting/inspection machine, and related services.
Tel (269) 343-5583
Fax (269) 343-5614
- DYNACAST INDUSTRIAL PRODUCTS 95**
Standard lines of electrical, electronic, hardware and construction fasteners. Also offer design and tooling for custom die castings, stampings, investment casting, custom rubber and plastic.
Tel (800) 811-7841
Fax (704) 927-2791
- E**
- ELECTRONIC HARDWARE CORPORATION 147**
Premier manufacturer of clamp knobs, handles, ratchet handles, and custom assemblies, has the largest selection of control products and industrial hardware.
Tel (631) 752-1950
- EFC INTERNATIONAL 79**
Global provider of specialty engineered component parts including clamps, panel fasteners, specialty nuts and more! A proven market leader in assembly innovation, Offers the most comprehensive line of specialty metal, plastic and electrical components
Tel (314) 434-2888
Fax (314) 434-2902
- EPICOR 113**
Business software is built for the everyday business processes of fastener distributors - including order entry, eCommerce, vendor-managed inventory, lot tracking, tagging, and landed costs.
Tel (800) 776-7438
- E & T FASTENERS, INC 75**
Molded, machined, and stamped plastic fasteners - uts, bolts, washers - Kynar, Teflon, PVC, Nylon, and Polypropylene. Low minimums.
Tel (704) 933-5774
- E-Z LOK 105**
Thread inserts for metal, wood and plastic
Tel (800) 234-5613
Fax (310) 353-4444



Creative marketing solutions for the fastener industry

*Don't settle for cookie-cutter designs, when **GRAPHIKA** has been offering custom, tailored solutions to fastener distributors and manufacturers for the last 15 years.*

With it's strong industry background, Graphika has built it's reputation by offering one-on-one customer service, producing exquisite designs, effective marketing and quality products - with exceptional results.

 224.489.9533
 info@graphikacreative.com
 www.graphikacreative.com



DESIGN



PRINT



WEB



EXHIBITION



BRANDING



MARKETING



your off-site, in-house comprehensive marketing department.

advertisers index

F

- FALL RIVER MFG CO., INC.** 29
Manufacturers of Stainless steel & non-ferrous fasteners
Tel (800) 275-6991
Fax (508) 675-8770
- FAR SRL** 101
Manufacturer of blind rivets, blind rivet nuts and tools. Made in Italy since 1957.
Tel +39 051 6009591
Fax +39 051 768284
- FASCOMP ELECTRONIC HARDWARE** 35
Male-female standoffs, female standoffs, male-male standoffs, spacers, shoulder screws, captive screws, thumbscrews, swage standoffs and spacers, handles and ferrules
Tel (407) 226-2112
Fax (407) 226-3370
- FASTAR, INC.** 91
Coiled and Slotted spring pins, dowel pins, cotter pins, taper pins, grooved and special pins
Tel (845) 369-7990
Fax (845) 369-7989
- FASTENER FAIR USA** 31
Fastener Fair USA will take place May 22-23, 2019 at the Cobo Center in Detroit, MI, bringing together manufacturers, distributors, suppliers and end users in this unique fastener, fixing, and joining technology exhibition. www.fastenerfair.com/usa
Tel (312) 809-9260
- FASTENER WEBSITE LINKS** 166
- FASTENER NEWS DESK** 221
- FCH SOURCING NETWORK** 221
- FORD FASTENERS, INC.** 15
410 stainless steel screws, sheet metal, self-drillers, thread cutters, self-piercing, EPDM sealing washers.
Tel (800) 272-3673
Fax (201) 487-1919

G

- GF&D SYSTEMS** 159
Your 'one-stop' supplier for grease fittings and accessories. Couplers and hose whips, great fitting caps, grease guns, custom designed fittings, assortments, private labeling and custom kitting.
Tel (800) 360-1318
Fax (262) 789-8640
- GLOBALFASTENERNEWS.COM** 231
- GOEBEL FASTENERS, INC.** 67
Innovative fastener solutions: blind rivets, self-tapping/drilling screws, toggles, strapping, wing seals, tools & safety equipment and insulation accessories.
Tel (713) 393-7007

- GRAPHIKA CREATIVE** 243
Creative marketing solutions tailored for the Fastener Industry. Supplier of design and finished materials for web, digital, email marketing, exhibitions, point of sale and corporate branding. Graphika - your off-site, in-house comprehensive marketing department. info@graphikacreative.com
Tel (224) 489-9533
- GREENSLADE & COMPANY, INC** 33
World's leading supplier of fastener inspection equipment, innovative gage design, and dimensional calibration.
Tel (817) 870-8888
Fax (817) 870-9199
- GROWERMETAL S.R.L.** 117
Specialized manufacturer in the production of security washers, blanked parts according to customer specifications and spring washers for railways.
Tel (973) 425-0769
Fax (973) 425-0762

H

- HANGER BOLT & STUD CO.** 191
USA Hanger bolts, studs, dowel screws, pins.
Tel (800) 537-7925
Fax (800) 994-2658
- HANSON RIVET & SUPPLY CO.** 53
Rivets, threaded inserts, riveting tools, riveting machines, washers
Tel (866) 61-RIVET (617-4838)
Fax (323) 221-5300
- HI-PERFORMANCE FASTENING SYSTEMS** 46
Leading manufacturer of specialty and proprietary cold headed fasteners serving the distribution, heavy truck, tiered automotive, agriculture, lawn & garden, appliance, consumer electronics, construction, renewable energy and off-road/emergency vehicle markets. With a wide range of capabilities, internal engineering services, external direct sales and application field support, indirect or direct end user support and an internal sales team we assist you.
Tel (630) 860-7766
- HILLSDALE TERMINAL** 194
Solderless terminals (vinyl, nylon & heat shrink). Instant tap connectors, wiring accessories
Tel (800) 447-3150
Fax (517) 849-9516

I

- ICS FLANGE** 41
Stocks flange bolts and nuts in Grade 5, 8, 8.8 and 10.9 in steel and stainless in any finish.
Tel (800) 231-0360
Fax (800) 586-2461

- IDEAL FASTENERS INC.** 153
Manufacturer of Socket Head Cap Screws
Tel (800) 821-8540
Fax (714) 632-3829
- IDEAL SUPPLY, INC.** 87
One of the largest Monel® fastener inventories in the world to meet your customer's military & commercial requirements to ASTM/MIL-SPEC.
Tel (847) 961-5900
Fax (847) 961-5300
- INDUSTRIAL RIVET & FASTENER CO.** 21
One name, one number, one source for rivets and RivetKing FreeSet Series.
Tel (800) BUY-RIVET
Fax (201) 750-1050

- INNOVATIVE COMPONENTS INC** 57
Manufacturer of plastic clamping knobs, quick release pins, wire rope lanyards, thread identifiers, and custom injection molding tools.
Tel (800) 566-2774
Fax (847) 885-9005

- INTERCORP** 1
Premium self-drilling, drywall, needle-point, pole gripper, stainless steel, outdoor, concrete, cement board, woodworking and special application.
Tel (800) 762-2004
Fax (714) 744-4672

- ISC - INTERCONTINENTAL SALES** 201
Fastener and Building Related Products. No minimum, same day shipping, free private labeling.
Tel (800) 741-4278
Fax (954) 943-6662

- INTERFAST GROUP** 123
Distributor/importer of drywall, deck, self-drilling and self-piercing screws.
Tel (800) 605-1233
Fax (909) 930-2183

- INTERNATIONAL FASTENERS, INC.** 149
Daggerz™ quality construction fasteners. Self-drill, drywall, deck, wood, concrete, clip, needle point screws, post frame screws, aluminum industry screws, EPDM bonded washers, bits & threaded rod.
Tel (888) 241-0203
Fax (888) 241-2096

- INxSQL** 111
Providing distribution ERP solutions designed for fastener distributors. Quality software, affordable price, industry leading support.
Tel (877) 446-9775

J

- JOHAN SMIT FASTENERS HOLLAND** 87
Manufacturer and supplier of steel nuts in the energy, petrochemical & steel construction.
Tel +31(0)786230088
- JTD STAMPING CO.** 181
Mfrs of washers and gaskets for over 45 years.
Tel (631) 449-7738

YOUR SOURCE

For Standard And Specialized Fasteners

Cotter pins, hitch pin clips, spring pins, clinch pins and more pins. Pins for industry. Pins for agriculture. Pins for OEM. Pins for every purpose and much, much more. From lock washers, D-rings, key rings and S-hooks. We offer our products in various sizes, shapes, materials and finishes. Check out our website for complete product details.

When applicable and specified, our pins conform to federal specifications. Supporting material test reports are kept on file.

As a proud USA manufacturer, we produce an extensive line of standard and specialized fasteners. Give us a call and let us show you why people have been relying on Western Wire Products since 1914.

And Let Us Give You A Hand With Customized Wire Shapes & Forms

If one of our standard parts will not meet your needs, we would be glad to give you a quote on a customized shape, stamping, or form made to your specifications.



Western Wire Products Co.
Since 1914

770 Sun Park Drive • Fenton, MD 63026 • 800-325-3770 • FAX 636-305-1119
e-mail: sales@westernwireprod.com www.westernwireprod.com

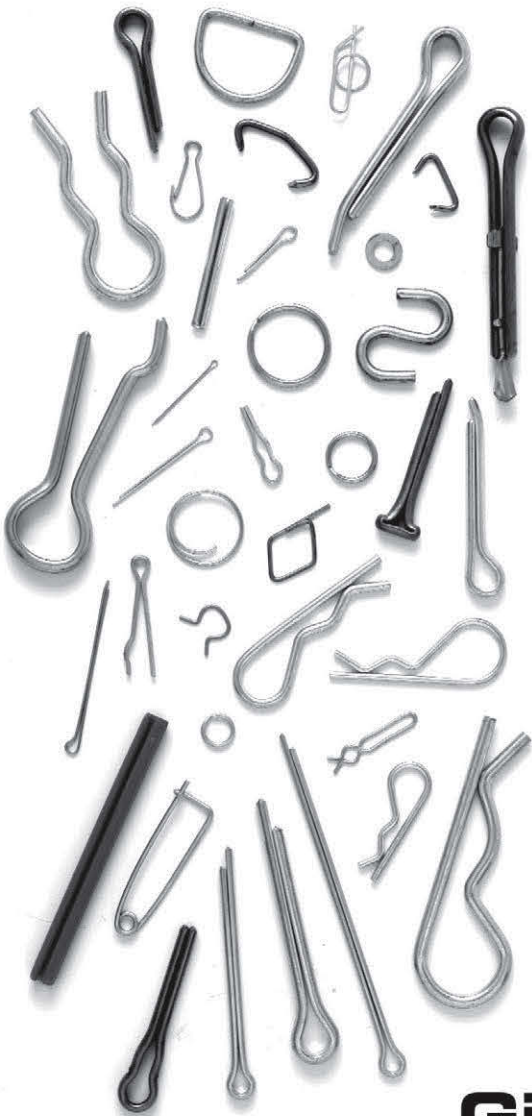

advertisers index

K

KEN FORGING 42, 43

Domestic manufacturer of eyebolts, nut eyebolts, rod ends, turnbuckles & fittings, eye nuts, pad eyes, D-rings, c-clamps & screws, swivel hoist ring. Custom forgings up to 250 lbs. Tel (888) 536-3674 Fax (440) 992-0360

KEY BELLEVILLES, INC. 197

Key Belleville disc springs - designed for your application. The best technology and materials providing the greatest possible economy. Tel (800) 245-3600 Fax (800) 847-1672

KINTER® 187

X-mas tree clips, binder posts and screws, binder rings, steel barrel bolts and screws, wall anchors, Tel (800) 323-2389 Fax (847) 623-0105

L

LELAND INDUSTRIES INC 135

Domestic manufacturer of bolts, nuts, screws in carbon or stainless. Custom threading and specials. Wire bending, threading to 4". Bolts to 6" x 3/4" dia, U-Bolts and Anchors. Tel (800) 263-3393 Fax (416) 291-0305

LINDSTROM 2

Industry's deepest metric component selection, small pack/custom packed fasteners and class C items, fabricated specials, and specialty inch standards Tel (800) 328-2430

LIPPINCOTT SUPPLY COMPANY 139

Importer and Master Distributor of threaded fasteners since 1948. Allthread, nuts, bolts, washers, self-drilling, deck and drywall screws. Tel (800) 244-1143 Fax (707) 552-3457

LOCKNUT TECHNOLOGY, INC 81

Manufacturer of All-Metal Prevailing Torque Locknuts and Flextop™ Locknuts. Tel (630) 628-5330 Fax (630) 628-5331

LOK-MOR, INC. 129

American-made locknuts at competitive prices. Tel (800) 843-7230 Fax (817) 453-2923

LORRI HUNT & ASSOCIATES 210

Professional coaching to help your organization reach its potential. ISO 9001 implementation. Tel (816) 474-3996

LUBRICATION COMPONENTS 215

OEM quality grease fitting manufacturer. Largest JIT inventory program in North America. Your grease fitting source! Tel (305) 418-9510 Fax (305) 418-9511

M

MAR-BRO MANUFACTURING 69

Domestic manufacturer of standards, specials, MS and NAS fasteners. Specializing in A286, 12 pt flange and hex flange fasteners. Tel (602) 278-8197 Fax (602) 269-1235

MEHTA TRADING INTERNATIONAL 112

The complete MILL stainless fastener source. Tel (972) 642-1012 Fax (972) 642-1244

METRIC & MULTISTANDARD 13

Providing quality metric industrial products and exceptional customer service since 1963 Tel (800) 431-2792 Fax (914) 769-5049

MM DISTRIBUTION, LLC 157

Stocking master importer of standard and specialty fasteners including floor board screws, solid rivets, blind rivets, rail bolts, drive anchors and liner screws. Value added bar coding, secondary process, kitting and small packaging. Tel (740) 335-9136 Fax (614) 467-3670

MW INDUSTRIES, INC - TEXAS 107

Washers, special fasteners and metal stamping for 35 years. ISO 9001:2008 cert. Tel (800) 875-3510 Fax (281) 233-0449

N

NATIONAL THREADED FASTENERS 211

Flange Bolts, Flange Nuts, Carriage Bolts, Plow Bolts and Washers. Online ordering. Package and bulk available. Importer and master distributor. Tel (440) 350-1430 Fax (440) 350-1676

NARRGANSETT SCREW CO. 163

Domestic manufacturer of Quality Cold Headed Fasteners - IFI Standard & ISO 9001:2015 Tel (860) 379-4059 Fax (860) 738-9234

ND INDUSTRIES INSIDE FRONT COVER, 45

Self-locking and self-sealing fastener processing, fastener inspection & sorting, chemical blending, bottling, and A2LA Lab testing. Tel (248) 655-2503

NORTH EAST FASTENERS (NEF) 11

AS9100 certified, supplying IFI, ANSI, MS, NAS, NASM, AN, DIN, JIS, JICIS high quality fasteners for commercial, military and aerospace. Tel (860) 589-3242 Fax (860) 589-6969

NOVA FASTENER CO. 217

Full line screws, nuts, bolts, washers, and fence related parts. Tel (800) 645-1234 Fax (631) 225-6828

O

OFFSHORE MILLING SERVICES, INC. 59

One-Stop for factory-direct fasteners, High quality, great service, on time delivery. Tel (503) 244-1516 Fax (503) 452-9855

OSSCO BOLT & SCREW CO., INC. 109

Distributor of nuts - full range Tel (800) 367-2688 Fax (401) 461-6970

P

PINNACLE CAPITAL CORP 239

Business Sales/Divestitures; Acquisitions and Acquisition Searches - since 1993. Tel (212) 267-8200

PIVOT POINT 73

Pins - clevis, cotter pins, quick release, locking - wire rope lanyards, stock and specials and award winning inventions Tel (800) 222-2231 Fax (920) 349-3253

PRESTIGE STAMPING 145

Manufacturer of washers & small stampings Tel (586) 773-2700 Fax (586) 773-2298

PRODUCT COMPONENTS CORP. 194

Machined and molded fasteners in many types of plastics including Nylon, PTFE, Acetal, PVC, Polypropylene, Polycarbonate and more! Woman-owned and operated; specializing in excellent customer service, competitive pricing, quick delivery and small minimums. Tel (925) 228-8930 Fax (925) 228-8933

R

RAF ELECTRONIC HARDWARE 151

Domestic standoffs, spacers, male-females, swage, male-male and modified parts. NAS fasteners. Tel (203) 888-2133 Fax (203) 888-9860

W.J. ROBERTS CO. 53

Spacers and standoffs. Hex and rounds 3/16 to 5/8 diameter. Standoffs in brass, aluminum, steel and stainless steel. Tel (781) 233-8176 Fax (781) 231-1456

ROTOR CLIP® INSIDE BACK COVER

Manufacturers of retaining rings, spiral rings, snap rings, wave springs and hose clamps. Tel (732) 469-7333 Fax (732) 469-7898

R&R ENGINEERING CO. 143

Bent bolts, wire forms. Quality craftsmanship. Tel (800) 979-1921 Fax (800) 345-9583

THE
DISTRIBUTOR'S

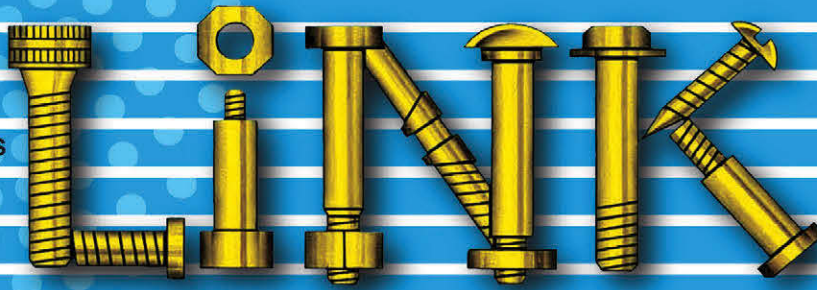

THE NATIONAL MAGAZINE FOR FASTENER DISTRIBUTORS

1

MAKE ADVERTISING YOUR PRIORITY FOR 2019

START WITH LINK MAGAZINE'S FIRST ISSUE OF THE NEW YEAR

MORE EXPOSURE. MORE OPPORTUNITIES. MORE VALUE.

EDITORIAL DEADLINE
November 17, 2018



ADVERTISING DEADLINE
November 28, 2018

TOLL-FREE 800-356-1639 TELEPHONE 239-643-2713

ADVERTISING tracey@linkmagazine.com EDITORIAL leojcoar@linkmagazine.com WWW.LINKMAGAZINE.COM

advertisers index

R

RUMCO FASTENER 72
Leading cold-heading manufacturer for over 30 years. Specializing in SEMS and custom fasteners including 2, 3 and 4- piece assemblies in ferrous and non-ferrous materials.
Tel (847) 364-5000

S

SCHNORR CORPORATION 197
An ISO 9001 & TS16949 certified manufacturer and distributor of disc springs, k-springs, safety washers, and load washers.
Tel (734) 677-2683
Fax (734) 975-0408

SCREW & SUPPLY CO. INC 173
Tamper-resistant security screws made in USA.
Tel (800) 223-1316
Fax (631) 567-3057

SEMS AND SPECIALS 157
Domestic fastener manufacturer with distribution smarts.
Tel (815) 874-0000
Fax (815) 874-0100

SHANGHAI FAST-FIX RIVET CORP 223
Rivet Manufacturer in China.
Tel 0086-21-58912860
Fax 0086-21-58912793

SHEAR-LOC PRODUCTS 154, 229
The original instant thumbscrews. The ultimate socket head cap screw accessory
Tel (800) 775-5668
Fax (949) 768-8705

SOLUTION INDUSTRIES 32, FOLD-OUT
Zinc plated socket products, hard to find items, specials from print or sample, semi-standards. Secondary processes. Blanket orders.
Tel (866) 297-8656
Fax (440) 816-9501

SPACE CITY SCREW & MFG. 125
Exotic and specialty bolts, nuts and washers. Duplex and super-duplex, 17-4ph all conditions. ISO 9001:2015 certified. Member ASTM.
Tel (281) 689-1081
Fax (281) 689-1086

SPIROL 99, 120
Coiled and slotted spring pins, solid pins, disc springs, alignment dowels and bushings, spacers, compression limiters, machined nuts, threaded inserts and shims.
Tel (800) 321-4679
Fax (860) 774-0487

SRC SPECIAL RIVETS CORP. 215
Blind Rivets. Company Rep: Tony DiMaio.
Tel & Fax (978) 521-0277

STAR STAINLESS SCREW CO. 49
Stainless fasteners - Inch, metric, standards, non-standards, import, domestic.
Tel (800) 323-1034
Fax (630) 595-3533

STELFAST INC. 65
Full line master distributor of inch and metric nuts, bolts, washers, screws, anchors, threaded rod, and studs. All platings available.
Tel (800) 729-9779
Fax (440) 879-0044

SUNCOR STAINLESS, INC. 201
Manufacturer of a complete selection of stainless steel hardware - industrial, marine, architectural, commercial, government and OEM markets.
Tel (508) 732-9191
Fax (508) 732-9798

SUPERIOR WASHER & GASKET CORP. 37
The single source supplier for all you washer and gasket needs. Made in the USA.
Tel (631) 273-8282
Fax (631) 273-8088

SWD INC. 193
Specializes in Black Oxide, Passivation, Phosphating, Dip Spin Coatings, Fastener Sorting and Packaging. Licensed applicator of Doerken, Magni and Yuken Organic Coatings.
Tel (630) 543-3003
Fax (630) 543-3028

T

TAMPER-PRUF SCREW, INC 207
Leader in Security Screws for over 40 years.
Tel (562) 531-9340
Fax (562) 531-2464

TORTOISE FASTENER CO 59
Specialty source for slow moving hex heads. Stainless, brass, silicon bronze, aluminum, nickel-copper and alloy 20 hex heads.
Tel (800) 697-8894
Fax (303) 371-0877

TUTTLE MANUFACTURING 241
Anchors, bent bolt specials, spade bolts, acme threaded bars
Tel (847) 381-7713

U

UC COMPONENTS 135
Vented, coated, plated and polished screws. RediVac® clean-packaged screws and O-rings. Custom products and prototypes.
Tel (408) 782-1929

UMETA OF AMERICA 231
Supplier of OEM quality grease fittings and guns
Tel (800) 595-5747
Fax (704) 799-1923

UNICORP 123
Manufacturer of American Standard and Metric Precision Electronic Hardware, fasteners and handles since 1971.
Tel (973) 674-1700

UNIQUE INDUSTRIES 127
Manufacturers of specialty threaded items
Tel (205) 668-0490
Fax (205) 668-0431

USA FASTENER GROUP, INC. 136
Founded in 2002, USA Fastener Group established itself as a recognized leader in the fastener industry. Located in Houston, TX
Tel (713) 641-4600

V

VERTEX DISTRIBUTION 177
National leader in fastener distribution. From stainless to metric and from inch to mill orders - Since 1881.
Tel (508) 431-1120

VIRGINIA FASTENERS 225
Specializing in HDG timber, hex, carriage, lag bolts, tie rods, nuts and washers.
Tel (800) 368-3430
Fax (757) 436-1460

VOLT INDUSTRIAL PLASTICS, INC. 9
American-made plastic fasteners, all types & quantities, custom molding since 1992.
Tel (800) 844-8024
Fax (870) 453-8707

W

WCL COMPANY 189
Specializing in reliable low-cost, engineered high-performance fasteners, fittings, plastic components, washers, nuts, and a wide array of fastener components - for over 60 years
Tel (800) 331-3816

WESTERN WIRE PRODUCTS 245
Cotter pins, custom wire forms, spring pins, d-rings, s-hooks, hitch pin clips, hog rings, key rings, and lock washers.
Tel (800) 325-3770
Fax (636) 305-1119

WILLIE WASHER MFG. 175
Special washers, stampings & prototypes.
Tel (847) 956-1344
Fax (847) 956-7943

X

XL SCREW CORPORATION FRONT COVER, 16
Importer of standard fasteners including hex cap screws, bolts, nuts, locknuts, thread forming screws, sheet metal screws, self-drilling screws, machine screws, washers and anchors, metrics and mill shipments.
Tel (847) 383-2300
Fax (847) 383-2345

Z

ZAGO MANUFACTURING CO. INC 179
Sealing fasteners and components - sealing screws, nuts, bolts, and swith boots. Providing MS3212/MS3213, NASM82496 parts for military and aerospace industries.
Tel (973) 643-6700
Fax (973) 643-4433

Hit Your Design Targets with Spiral Retaining Rings

from Rotor Clip

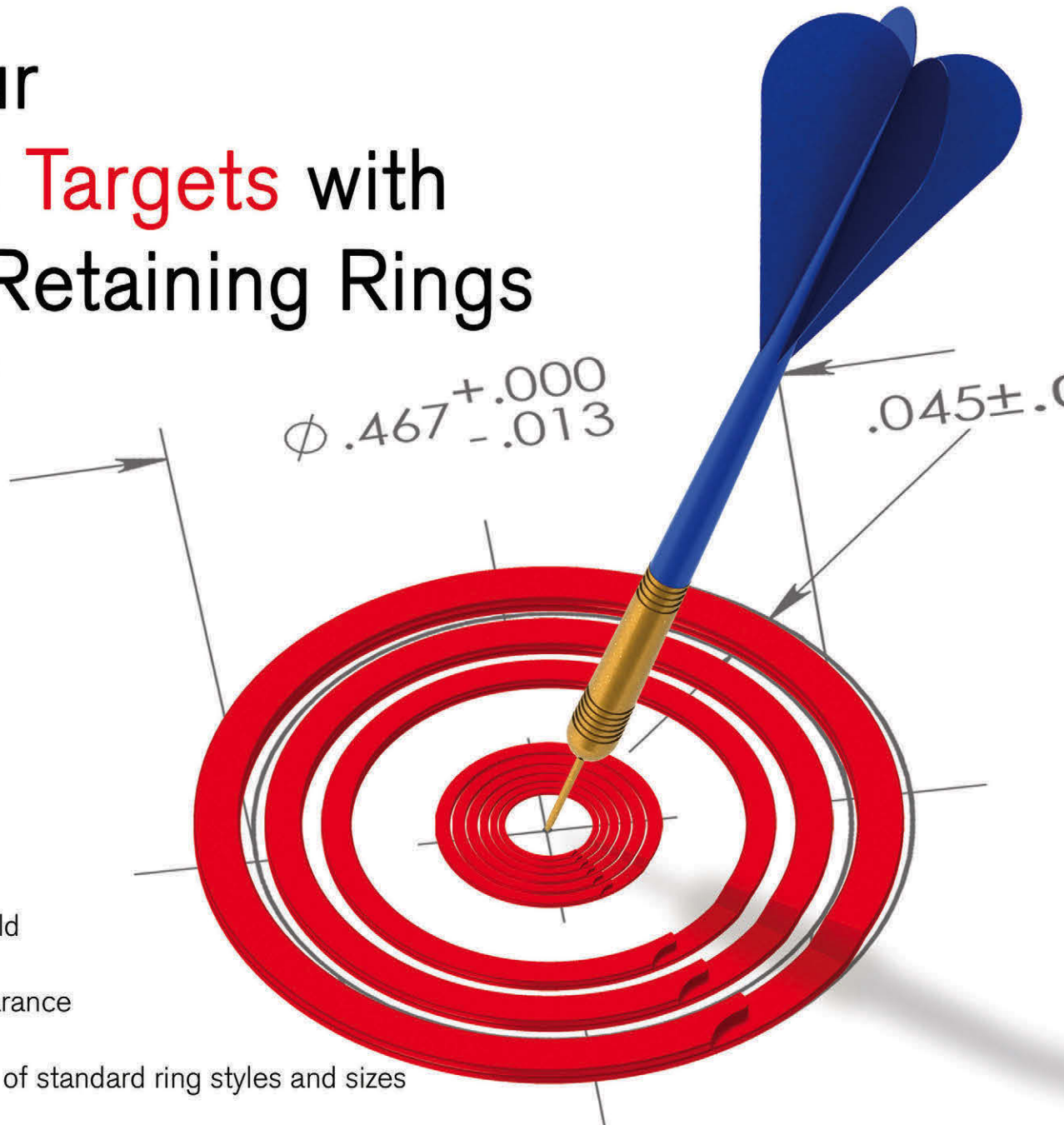

- 360° secure hold
- More radial clearance
- Large selection of standard ring styles and sizes
- No cost for custom ring tooling
- Available in carbon and stainless steel, as well as exotic alloys

For more information please
visit www.rotorclip.com
or via sales@rotorclip.com

Certified to: IATF 16949 • ISO 9001 • AS9100 • ISO 14001



Get Rotor Clip's
FREE eBook
"Still Made In America"
www.rotorclip.com/ebook

Designed for Quality

R ROTOR CLIP®

Visit us at the
International Fastener Expo
October 30 - November 1, 2018
Mandalay Bay, Las Vegas
Booth #3423

INVESTING IN THE SUCCESS OF DISTRIBUTORS WITH LOWER STAINLESS PRICING!



NATIONAL
PREPAID
FREIGHT



SAVE MONEY BY BUNDLING

**NEW
LOWER
PRICING**

**OVER
20 MILLION
POUNDS
IN INVENTORY**



- Hex Cap Screws
- Nuts
- Washers
- Sockets
- Threaded Rod
- Pins

- **Construction Screws**
- **Square Head Set Screws**
- **Machine Screws**
- **Self Tapping Screws**
- **Self Drilling Screws**
- **Lag Screws**
- Carriage Bolts
- Anchors
- Rivets

INTERNATIONAL
FASTENER EXPO
Booth # 3323



BRIGHTON-BEST INTERNATIONAL

www.brighton**BEST**.com • 1 - 8 0 0 - 2 7 5 - 0 0 5 0

